

## 3-Phase PV Grid-Connected Inverter

### User Manual

**SG3.0RT / SG4.0RT / SG5.0RT / SG6.0RT / SG7.0RT /  
SG8.0RT / SG10RT / SG12RT / SG15RT / SG17RT /  
SG20RT**





# All Rights Reserved

## **All Rights Reserved**

No part of this document can be reproduced in any form or by any means without the prior written permission of Sungrow Power Supply Co., Ltd (hereinafter "SUNGROW").

## **Trademarks**

**SUNGROW** and other Sungrow trademarks used in this manual are owned by SUNGROW.

All other trademarks or registered trademarks mentioned in this manual are owned by their respective owners.

## **Software Licenses**

- It is prohibited to use data contained in firmware or software developed by SUNGROW, in part or in full, for commercial purposes by any means.
- It is prohibited to perform reverse engineering, cracking, or any other operations that compromise the original program design of the software developed by SUNGROW.

# About This Manual

The manual mainly contains the product information, as well as guidelines for installation, operation and maintenance. The manual does not include complete information about the photovoltaic (PV) system. The reader can get additional information about other devices at [www.sungrowpower.com](http://www.sungrowpower.com) or on the webpage of the respective component manufacturer.

## Validity

This manual is valid for the following inverter models:

- SG3.0RT
- SG4.0RT
- SG5.0RT
- SG6.0RT
- SG7.0RT
- SG8.0RT
- SG10RT
- SG12RT
- SG15RT
- SG17RT
- SG20RT

They will be referred to as "inverter" hereinafter unless otherwise specified.

## Target Group

This manual is intended for inverter owners who will have the ability to interact with the inverter and qualified personnel who are responsible for the installation and commissioning of the inverter. Qualified personnel should have the following skills:

- Training for installation and commissioning of electrical system, as well as dealing with hazards
- Knowledge of the manual and other related documents
- Knowledge of the local regulations and directives

## How to Use This Manual

Read the manual and other related documents before performing any work on the inverter. Documents must be stored carefully and be available at all times.

Contents may be periodically updated or revised due to the product development. The manual content of subsequent versions of the inverter may be subject to change. The latest manual can be found at [support.sungrowpower.com](http://support.sungrowpower.com).



## Symbols

Important instructions contained in this manual should be followed during installation, operation and maintenance of the inverter. They will be highlighted by the following symbols.

### DANGER

Indicates a hazard with a high level of risk that, if not avoided, will result in death or serious injury.

### WARNING

Indicates a hazard with a medium level of risk that, if not avoided, could result in death or serious injury.

### CAUTION

Indicates a hazard with a low level of risk that, if not avoided, could result in minor or moderate injury.

### NOTICE

Indicates a situation that, if not avoided, could result in equipment or property damage.



Indicates additional information, emphasized contents or tips that may be helpful, e.g. to help you solve problems or save time.



# Contents

---

All Rights Reserved .....	I
About This Manual .....	II
<b>1 Safety .....</b>	<b>1</b>
1.1 PV Panels .....	1
1.2 Utility Grid .....	1
1.3 Inverter .....	2
<b>2 Product Description .....</b>	<b>4</b>
2.1 System Introduction .....	4
2.2 Product Introduction .....	5
2.3 Symbols on the Product .....	7
2.4 LED Indicator .....	8
2.5 Circuit Diagram .....	8
2.6 Function Description .....	9
<b>3 Unpacking and Storage .....</b>	<b>14</b>
3.1 Unpacking and Inspection .....	14
3.2 Inverter Storage .....	14
<b>4 Mechanical Mounting .....</b>	<b>15</b>
4.1 Safety during Mounting .....	15
4.2 Location Requirements .....	15
4.2.1 Environment Requirements .....	16
4.2.2 Carrier Requirements .....	16
4.2.3 Angle Requirements .....	16
4.2.4 Clearance Requirements .....	17
4.3 Installation Tools .....	18
4.4 Moving the Inverter .....	19
4.5 Installing the Inverter .....	19
<b>5 Electrical Connection .....</b>	<b>22</b>
5.1 Safety Instructions .....	22
5.2 Terminal Description .....	22
5.3 Electrical Connection Overview .....	24
5.4 External Grounding Connection .....	25

5.4.1 External Grounding Requirements.....	26
5.4.2 Connection Procedure.....	26
5.5 AC Cable Connection .....	27
5.5.1 AC Side Requirements .....	27
5.5.2 Assembling the AC Connector (< 15 kW) .....	28
5.5.3 Installing the AC Connector (< 15 kW) .....	30
5.5.4 Assembling the AC Connector (≥ 15 kW) .....	31
5.5.5 Installing the AC Connector (≥ 15 kW) .....	33
5.6 DC Cable Connection .....	35
5.6.1 PV Input Configuration .....	36
5.6.2 Assembling the PV Connectors .....	37
5.6.3 Installing the PV Connectors .....	39
5.7 WiNet-S Connection .....	40
5.7.1 Ethernet Communication .....	40
5.7.2 WLAN Communication .....	42
5.8 WiFi Connection (for Brazil).....	43
5.9 Meter Connection .....	44
5.9.1 Assembling the COM Connector .....	44
5.9.2 Installing the COM Connector .....	46
5.10 RS485 Connection.....	47
5.10.1 RS485 Communication System .....	47
5.10.2 Assembling the COM Connector .....	47
5.10.3 Installing the COM Connector.....	50
5.11 DO Connection .....	51
5.12 DRM Connection .....	51
5.13 DI Connection .....	52
5.14 NS Protection Connection .....	55
<b>6 Commissioning .....</b>	<b>56</b>
6.1 Inspection before Commissioning .....	56
6.2 Powering on the System .....	56
6.3 App Preparation .....	57
6.4 Creating a Plant.....	57
6.5 Initializing the Device .....	60
6.6 Configuring the Plant .....	64
<b>7 iSolarCloud App .....</b>	<b>68</b>
7.1 Brief Introduction .....	68

7.2 Installing the App .....	68
7.3 Account Registration.....	69
7.4 Login .....	70
7.4.1 Requirements .....	70
7.4.2 Login Procedure .....	70
7.5 Initial Settings.....	72
7.6 Function Overview.....	73
7.7 Home .....	74
7.8 Run Information.....	75
7.9 Records .....	76
7.10 More.....	79
7.10.1 System Parameters.....	80
7.10.2 Operation Parameters .....	80
7.10.3 Power Regulation Parameters.....	82
7.10.4 Communication Parameters.....	86
7.10.5 Firmware Update .....	87
7.10.6 Auto-test.....	88
7.10.7 SPI(Only for Italy).....	89
<b>8 System Decommissioning .....</b>	<b>91</b>
8.1 Disconnecting the Inverter.....	91
8.2 Dismantling the Inverter .....	91
8.3 Disposal of the Inverter .....	92
<b>9 Troubleshooting and Maintenance .....</b>	<b>93</b>
9.1 Troubleshooting .....	93
9.2 Maintenance .....	102
9.2.1 Maintenance Notices.....	102
9.2.2 Routine Maintenance .....	103
9.2.3 Fan Maintenance .....	104
<b>10 Appendix .....</b>	<b>106</b>
10.1 Technical Data.....	106
10.2 Quality Assurance .....	116
10.3 Contact Information .....	116



# 1 Safety

The device has been designed and tested strictly according to international safety regulations. Read all safety instructions carefully prior to any work and observe them at all times when working on or with the device.

Incorrect operation or work may cause:

- Injury or death to the operator or a third party;
- Damage to the device and other properties.

All detailed work-related safety warnings and notes are specified at critical points in this manual.



- The safety instructions in this manual cannot cover all the precautions that should be followed. Perform operations considering actual onsite conditions.
- SUNGROW shall not be held liable for any damage caused by violation of the safety instructions in this manual.
- When installing, operating, and maintaining the device, comply with local laws and regulations. The safety precautions in this manual are only supplements to local laws and regulations.

## 1.1 PV Panels

### DANGER

**PV strings will produce electrical power when exposed to sunlight and can cause a lethal voltage and an electric shock.**

- **Always keep in mind that the inverter is dual power supplied. Electrical operators must wear proper personal protective equipment: helmet, insulated footwear, gloves, etc.**
- **Before touching the DC cables, operator must use a measuring device to ensure that the cable is voltage-free.**
- **The operator must follow all warnings on the PV strings and in its manual.**

## 1.2 Utility Grid

Follow the regulations related to the utility grid.

**NOTICE**

All electrical connections must be in accordance with local and national standards. Only with the permission of the local utility grid company, the inverter can be connected to the utility grid.

## 1.3 Inverter

**⚠ DANGER**

**Danger to life from electric shocks due to live voltage**  
Do not open the enclosure at any time. Unauthorized opening will void warranty and warranty claims and in most cases terminate the operating license.

**⚠ WARNING**

**Risk of inverter damage or personal injury**

- Do not connect or disconnect the PV and AC connectors when the inverter is running.
- Wait at least 10 minutes for the internal capacitors to discharge after all electric devices are removed and the inverter is powered off.
- Ensure that there is no voltage or current before connecting or disconnecting the PV and AC connectors.

**⚠ WARNING**

**All safety instructions, warning labels, and nameplate on the inverter:**

- Must be clearly legible.
- Should not be removed or covered.

**⚠ CAUTION**

**Risk of burns due to hot components!**

- Do not touch any hot parts (such as the heat sink) during operation. Only the DC switch can safely be touched at any time.
- Even if the inverter is shut down, it may still be hot and cause burns. Wear protective gloves before operating the inverter after it cools down.



**NOTICE**

**Only qualified personnel can perform the country setting. Unauthorized alteration may cause a breach of the type-certificate marking.**

**Risk of inverter damage due to electrostatic discharge (ESD)!**

**By touching the electronic components, you may damage the inverter. For inverter handling, be sure to:**

- **avoid any unnecessary touching;**
- **wear a grounding wristband before touching any connectors.**

## 2 Product Description

### 2.1 System Introduction

The inverter is a transformerless 3-phase PV grid-connected inverter. As an integral component in the PV power system, the inverter is designed to convert the direct current power generated from the PV modules into grid-compatible AC current and feeds the AC current to the utility grid.

#### **⚠ WARNING**

- **The inverter must only be operated with PV strings with class II protection in accordance with IEC 61730, application class A. It is not allowed for the positive pole or the negative pole of the PV strings to be grounded. This can cause damage to the inverter.**
- **Damages to the product due to a faulty or damaged PV installation are not covered by warranty.**
- **Any use other than the one described in this document is not permitted.**
- **During the installation and operation of the inverter, please ensure that the positive or negative polarities of PV strings do not short-circuit to the ground. Otherwise, an AC or DC short-circuit may occur, resulting in equipment damage. The damage caused by this is not covered by the warranty.**

The intended usage of the inverter is illustrated in the following figure.

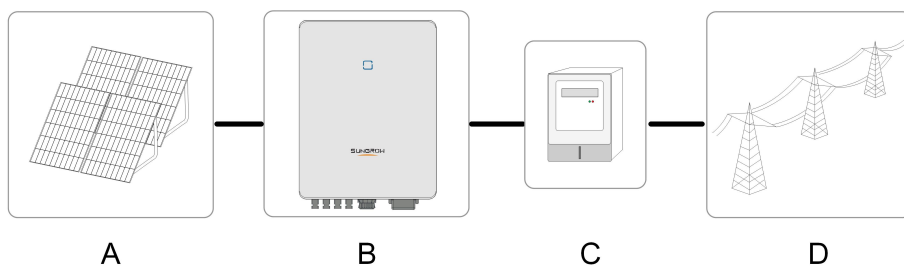
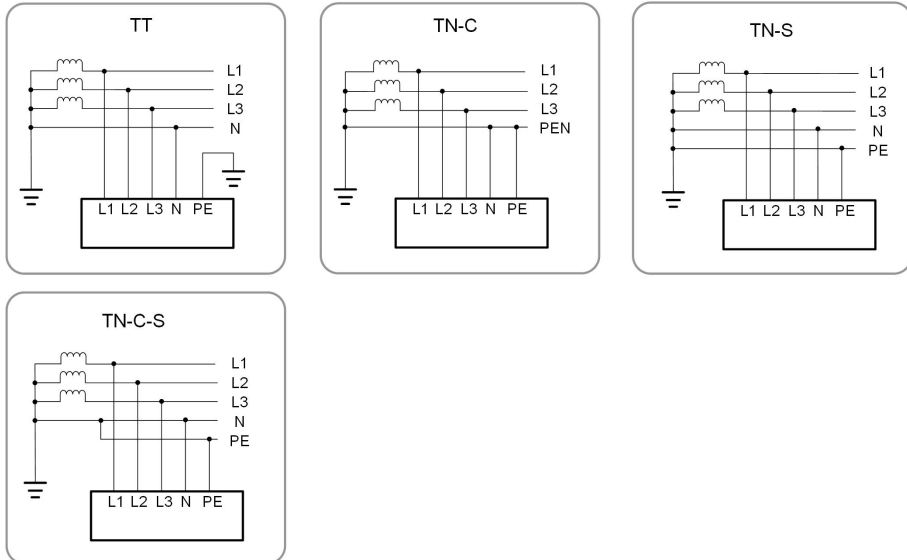

**figure 2-1** Inverter Application in PV Power System

Item	Description	Note
A	PV strings	Compatible with monocrystalline silicon, polycrystalline silicon, and thin-film modules without grounding
B	Inverter	SG3.0RT, SG4.0RT, SG5.0RT, SG6.0RT, SG7.0RT, SG8.0RT, SG10RT, SG12RT, SG15RT, SG17RT, SG20RT

Item	Description	Note
C	Metering device	Meter cupboard with power distribution system
D	Utility grid	TT, TN-C , TN-S , TN-C-S

The following figure shows the common grid configurations.



## 2.2 Product Introduction

### Model Description

The model description is as follows (take SG10RT as an example):

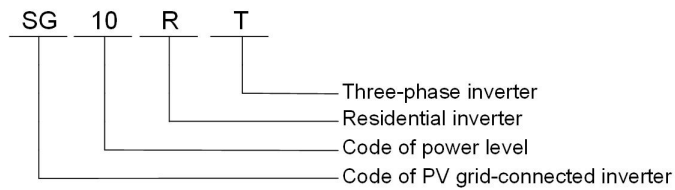

### Appearance

The following figure shows the dimensions of the inverter. The image shown here is for reference only. The actual product received may differ.

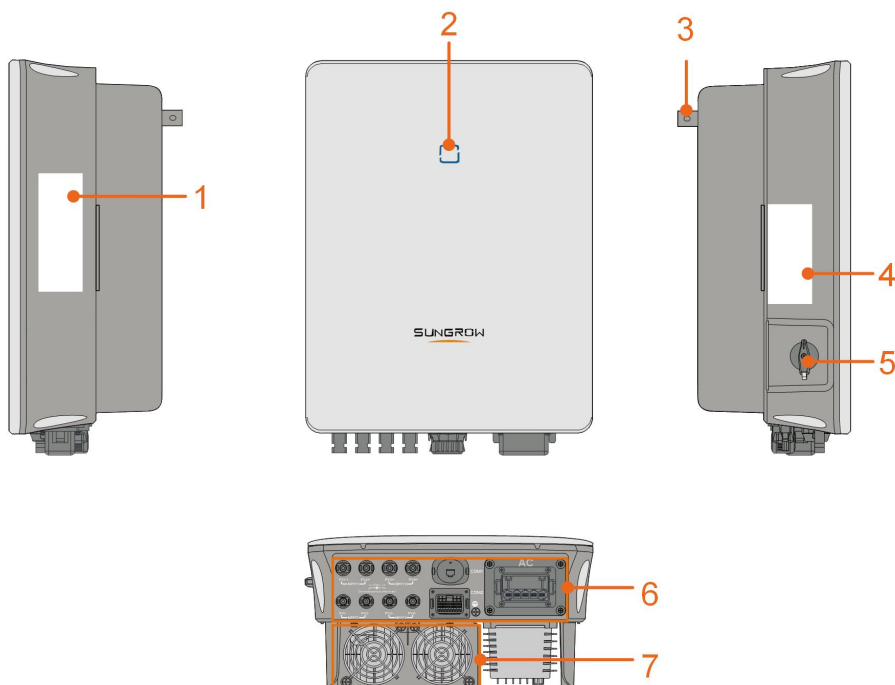

**figure 2-2** Inverter Appearance

No.	Name	Description
1	Nameplate	To clearly identify the product, including device model, S/N, important specifications, marks of certification institutions, etc.
2	LED indicator	To indicate the current working state of the inverter.
3	Hanger	Complement to the included wall-mounting bracket for hanging the inverter.
4	Label	Information about <b>COM2</b> pin definition, supported DRM modes, etc.
5	DC switch	To safely disconnect the DC circuit whenever necessary.
6	Electrical connection area	DC terminals (SG20RT for example), AC terminal, additional grounding terminal and communication terminals.
7	Fans	Optimization of the inverter's heat dissipation. Only the SG15RT, SG17RT and SG20RT are equipped with fans.

### Dimensions

The following figure shows the dimensions of the inverter.

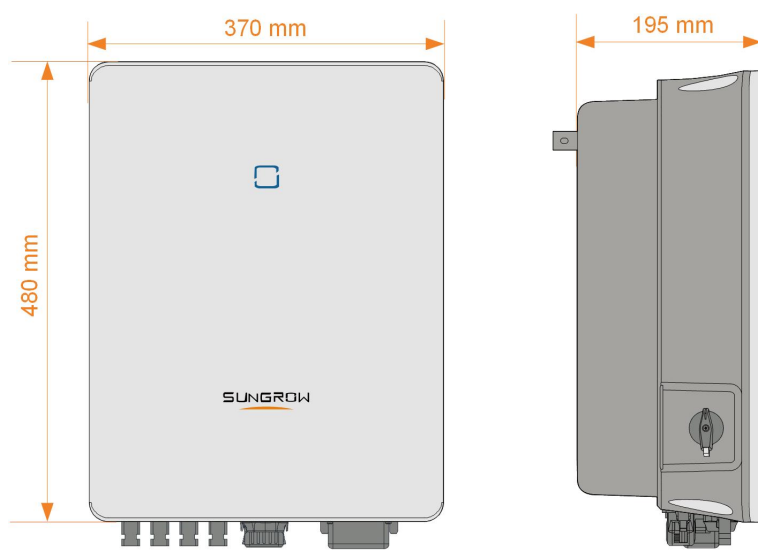













figure 2-3 Dimensions of the Inverter(in mm)

## 2.3 Symbols on the Product

Symbol	Explanation
	Regulatory compliance mark.
	TÜV mark of conformity.
	CE mark of conformity.
	UKCA mark of conformity.
	Do not dispose of the inverter together with household waste.
	The inverter does not have a transformer.
	Disconnect the inverter from all the external power sources before maintenance!
	Read the user manual before maintenance!
	Burn danger due to the hot surface that may exceed 60°C.



Symbol	Explanation
	<p>Danger to life due to high voltages!</p> <p>Do not touch live parts for 10 minutes after disconnection from the power sources.</p> <p>Only qualified personnel can open and maintain the inverter.</p>
	<p>Additional grounding point.</p>

\* The table shown here is for reference only. The actual product received may differ.

## 2.4 LED Indicator

The LED indicator on the front of the inverter indicates the working state of the inverter.

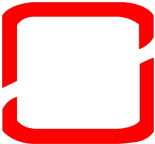
table 2-1 State description of the LED indicator

LED color	State	Definition
 Blue	<p>On</p> <p>Flashing</p>	<p>The inverter is operating normally.</p> <p>The inverter is at standby or startup state (not feeding power into the grid).</p>
 Red	<p>On</p>	<p>A system fault has occurred.</p>
 Gray	<p>Off</p>	<p>Both the AC and DC sides are powered down.</p>

## 2.5 Circuit Diagram

The following figure shows the main circuit of the inverter.

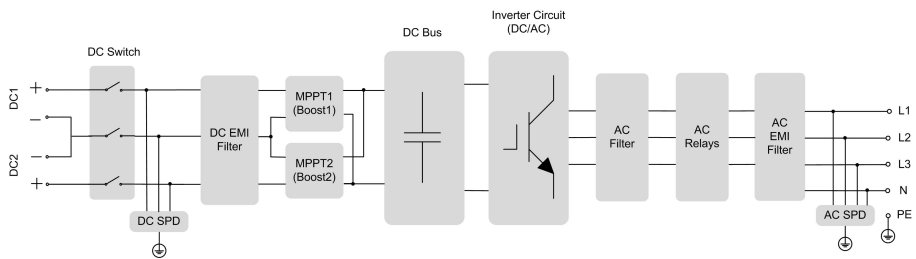

**figure 2-4** Circuit Diagram (SG5.0RT for example)

- The DC switch is used to safely disconnect the DC circuit.
- The MPPT is utilized for DC input to ensure the maximum power from the PV array at different PV input conditions.
- The inverter circuit converts the DC power into AC power and generates AC power to loads or utility grid through the AC terminal.
- The protection circuit ensures the safe operation of the device and personal safety.

## 2.6 Function Description

### Basic Function

- Conversion function

The inverter converts the DC power from the PV array to the AC power, in conformity with the grid requirements.

- Data storage

The inverter logs running information, error records, etc.

- Parameter configuration

The inverter provides various parameter configurations for optimal operation. Parameters can be set via the iSolarCloud App or the cloud server. For further configurations, which exceeds the usual parameters configuration, please contact Sungrow.

- Communication interface

The inverter is equipped with two communication interfaces. The communication device can be connected to the inverter via both interfaces.

After communication connection is established, users can view inverter information, operational data and can set inverter parameters through the iSolarCloud.



It is recommended to use the communication module from SUNGROW. Using a device from other companies may lead to communication failure or other unexpected damage.

- Protection Function

Several protective functions are integrated in the inverter, including short circuit protection, grounding insulation resistance monitoring, residual current protection, grid monitoring, DC overvoltage/overcurrent protection, etc.

### Earth Fault Alarm

The inverter is equipped with a DO relay for the local earth fault alarm. The additional equipment required is a light indicator and/or a buzzer that needs additional power supply.

After the connection, if the earth fault occurs, the DO dry-contact will switch on automatically to signal the external alarm.

### DRM ("AU"/"NZ")

The DRM function is only applicable to a single inverter.

The inverter provides terminals for connecting to a Demand Response Enabling Device (DRED). After the connection, the DRED asserts demand response modes (DRMs). The inverter detects and initiates a response to all supported demand response modes listed in the following table.

table 2-2 Demand Response Mode Explanation

Mode	Explanation
DRM0	The inverter is in the state of shutdown.

### Ripple Control

The inverter provides terminals (DRM) for connecting to a Ripple Control Receiver (RCR). After the connection, the grid dispatching center issues regulation instructions via dry contact (DI). The inverter can control power output according to the local preset instructions.

### PID Recovery

- For positive voltage scheme, after the PID function is enabled, the voltage to ground of all PV strings is greater than 0, and therefore the PV string-to-ground voltage is a positive value.

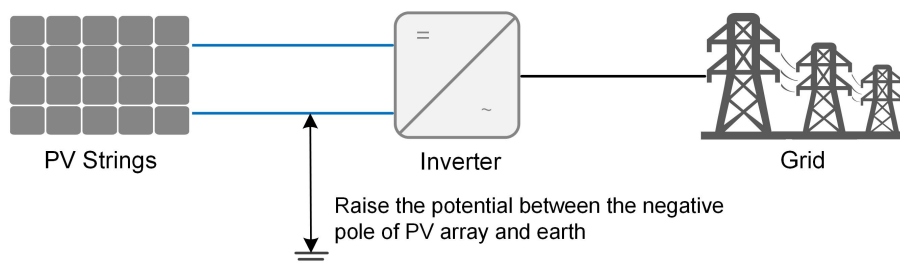

- For negative voltage scheme, after the PID function is enabled, the voltage to ground of all PV strings is lower than 0, and therefore the PV string-to-ground voltage is a negative value.



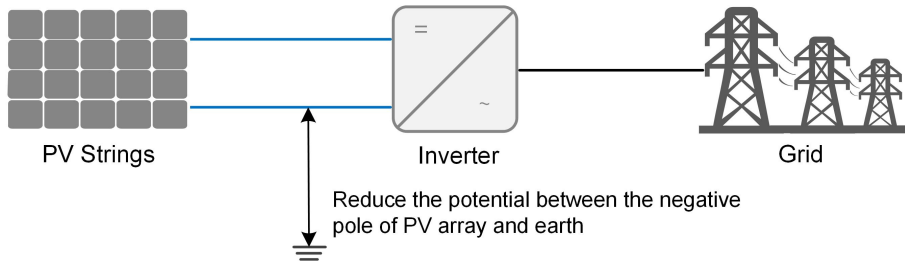

#### NOTICE

- **Before enabling the PID recovery function, make sure the voltage polarity of the PV modules to ground meets requirement. If there are any questions, contact the PV module manufacturer or read its corresponding user manual.**
- **If the voltage scheme for the PID recovery function does not meet the requirement of corresponding PV modules, the PID function will not work as expected or even damage the PV modules.**

When the inverter is not running, the PID module will apply inverse voltage to PV modules, to restore the degraded modules.



- If the PID recovery function is enabled, it only works at night.
- After the PID recovery function is enabled, the voltage of the PV strings to ground is 500 V DC by default, and the default value can be modified through the App.

#### Auto-test (for Italy CEI0-21 Grid Code Only)

The Italy CEI0-21 grid code requires auto-test for the inverter before grid connection. During the auto-test, the inverter checks the protection threshold and protection time of the 1-level overvoltage (59.S1), 2-level overvoltage (59.S2), 1-level undervoltage (27.S1), 2-level undervoltage (27.S2), 1-level overfrequency (81>.S1), 2-level overfrequency (81>.S2), 1-level underfrequency (81<.S1), 2-level underfrequency (81<.S2) to ensure that the inverter could meet the requirements of CEI0-21 to protect the grid from abnormality after the inverter is operational.

#### SPI Function(Only for Italy)

The inverter SPI interface, only for Italy, is able to easily choose the grid protection mode based on the local plant requirements:

- Local SPI Mode: protected by the preset values in inverter.
- External SPI Mode: protected by a separate SPI protection device on site.

Plant Size	≤ 11.08 kVA		> 11.08 kVA		
	SPI Control Modes	Local SPI Mode (Default in Inverter)		Local SPI Mode (Default in Inverter)	
SPI Interface	Integrated in Inverter		Integrated in Inverter		Separate SPI Protection Device on Site
External SPI Signal Setting	0	0	0	0	1
Local SPI Signal Setting	0 (Default in Inverter)	1	0 (Default in Inverter)	1	1
59.S1	253 V / ≤ 603 s	253 V / ≤ 603 s	253 V / ≤ 603 s	253 V / ≤ 603 s	253 V / ≤ 603 s
59.S2	264.5 V / 0.2 s	264.5 V / 0.2 s	264.5 V / 0.2 s	264.5 V / 0.2 s	264.5 V / ≤ 4 s
27.S1	195.5 V / 1.5 s	195.5 V / 1.5 s	195.5 V / 1.5 s	195.5 V / 1.5 s	195.5 V / ≤ 4 s
27.S2	34.5 V / 0.2 s	34.5 V / 0.2 s	34.5 V / 0.2 s	34.5 V / 0.2 s	34.5 V / ≤ 4 s
81>.S1	—	50.2 Hz / 0.1 s	—	50.2 Hz / 0.1 s	51.5 Hz / ≤ 4 s
81<.S1	—	49.8 Hz / 0.1 s	—	49.8 Hz / 0.1 s	47.5 Hz / ≤ 4 s
81>.S2	51.5 Hz / 0.1 s	51.5 Hz / 0.1 s	51.5 Hz / 0.1 s	51.5 Hz / 0.1 s	51.5 Hz / ≤ 4 s
81<.S2	47.5 Hz / 0.1 s	47.5 Hz / 0.1 s	51.5 Hz / 0.1 s	51.5 Hz / 0.1 s	47.5 Hz / ≤ 4 s
Notes	—	—	—	—	Values from SPI Protection Device on site shall not exceed the above

#### AFCI Function(Optional)

- AFCI activation

This function can be enabled to detect whether serial fault arc occurs in the loop between PV array and inverter.

- AFCI self-test

This function is intended to test whether AFCI works as normal.

- Clear AFCI Alarm

When the inverter detects the PID alarm, it stops working. Clear the PID alarm so that the inverter can restart the detection.



The fault arc detection function meets the standard requirements, please test under the working conditions as required by the standard.

## 3 Unpacking and Storage

### 3.1 Unpacking and Inspection

The device is thoroughly tested and strictly inspected before delivery. Nonetheless, damage may still occur during shipping. For this reason, please conduct a thorough inspection after receiving the device.

- Check the packing case for any visible damage.
- Check the scope of delivery for completeness according to the packing list.
- Check the inner contents for damage after unpacking.

Contact SUNGROW or the transport company in case of any damage or incompleteness, and provide photos to facilitate services.

Do not dispose of the original packing case. It is recommended to store the device in the original packing case when the device is decommissioned.

### 3.2 Inverter Storage

Proper storage is required if the inverter is not installed immediately.

- Store the inverter in the original packing case with the desiccant inside.
- The storage temperature must be always between  $-30^{\circ}\text{C}$  and  $+70^{\circ}\text{C}$ , and the storage relative humidity must be always between 0 and 95 %, non-condensing.
- In case of stacking storage, the number of stacking layers should never exceed the limit marked on the outer side of the packing case.
- The packing case should be upright.
- If the inverter has been stored more than half a year, the qualified personnel should thoroughly check and test it before installation.

## 4 Mechanical Mounting

### ⚠ WARNING

Respect all local standards and requirements during mechanical installation.

### 4.1 Safety during Mounting

### ⚠ DANGER

Make sure there is no electrical connection before installation.

In order to avoid electric shock or other injury, make sure that holes will not be drilled over any electricity or plumbing installations.

### ⚠ CAUTION

Risk of injury due to improper handling!

- Always follow the instructions when moving and positioning the inverter.
- Improper operation may cause injuries or serious wounds.

In the case of poor ventilation, the system performance may compromise.

- Keep the heat sinks uncovered to ensure heat dissipation performance.

### 4.2 Location Requirements

Select an optimal mounting location for safe operation, long service life and expected performance.

- The inverter with protection rating IP65 can be installed both indoors and outdoors.
- Install the inverter at a place convenient for electrical connection, operation, and maintenance.

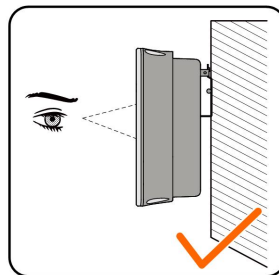
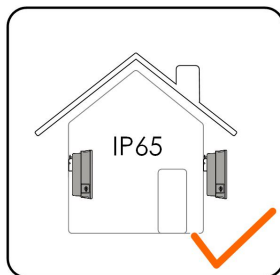

### 4.2.1 Environment Requirements

- The installation environment must be free of inflammable or explosive materials.
- The location should be not accessible to children.
- The ambient temperature and relative humidity must meet the following requirements.

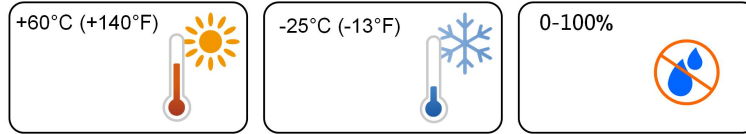

- Avoid direct exposure to sun, rain and snow.
- The inverter should be well ventilated. Ensure air circulation.
- Never install the inverter in living areas. The inverter will generate noise during operation, affecting daily life.

### 4.2.2 Carrier Requirements

The concrete wall should be capable of withstanding a force of four times the weight of the inverter and be suitable for the dimensions of the inverter.

The installation carrier should meet the following requirements:

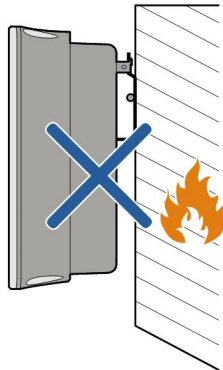

### 4.2.3 Angle Requirements

Install the inverter vertically. Never install the inverter horizontally, or at forward/backward tilted, side tilted, or upside down.

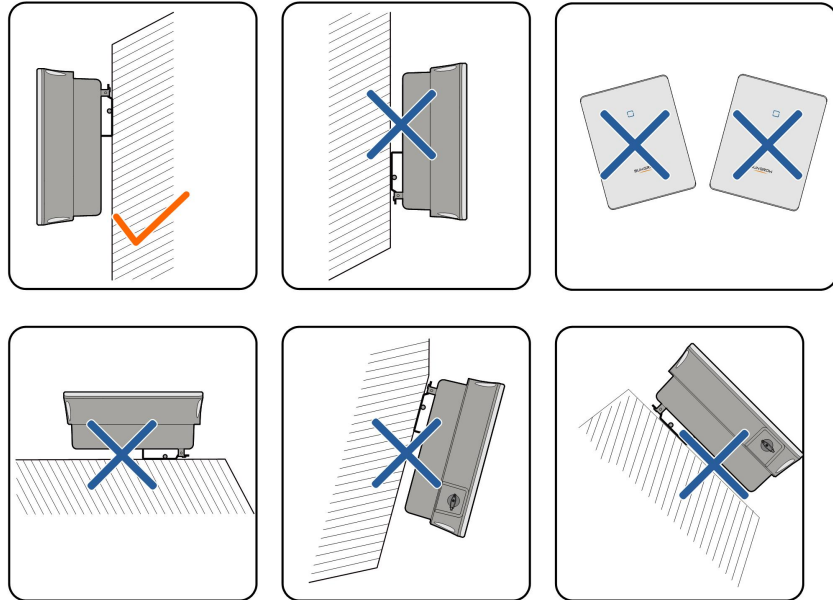

#### 4.2.4 Clearance Requirements

Reserve enough clearance around the inverter to ensure sufficient space for heat dissipation.

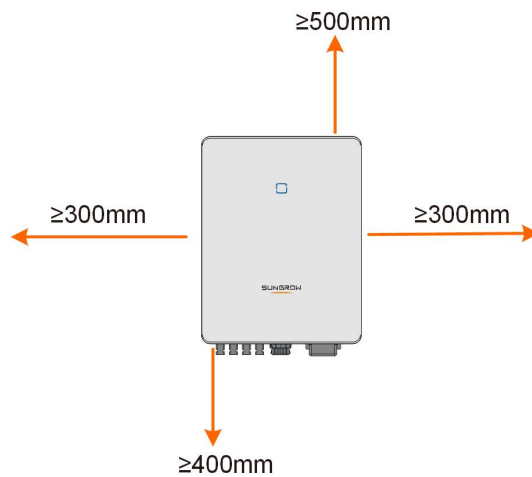

In case of multiple inverters, reserve specific clearance between the inverters.

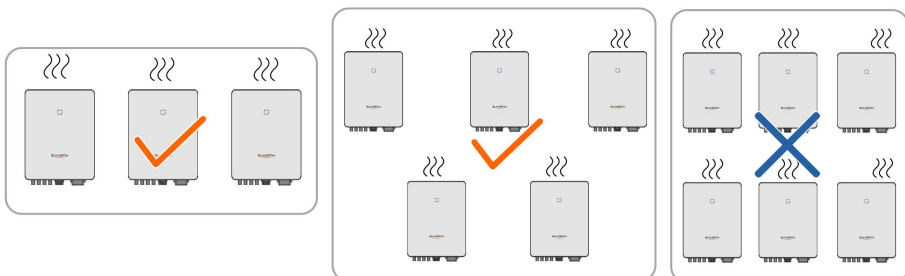

Install the inverter at an appropriate height for ease of viewing LED indicator and operating switch(es).

### 4.3 Installation Tools

Installation tools include but are not limited to the following recommended ones. If necessary, use other auxiliary tools on site.

table 4-1 Tool specification

			
Goggles	Earplugs	Dust mask	Protective gloves
			
Insulated shoes	Utility knife	Marker	Wrist strap
			
Wire cutter	Wire stripper	Hydraulic plier	Rubber mallet
			
Hammer drill (φ10)	Phillips screwdriver (M3, M4, M6)	Electric screwdriver (M3, M4, M6)	Wrench (30 mm, 35 mm, 46 mm)
			
RJ45 crimping tool	Vacuum cleaner	Measuring tape	Heat shrink tubing



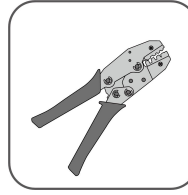
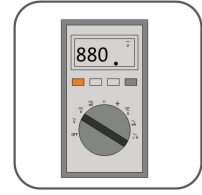

Heat gun

MC4 terminal crimping tool (4 mm<sup>2</sup>–6 mm<sup>2</sup>)Tube terminal crimping tool (0.5 mm<sup>2</sup>–1.0 mm<sup>2</sup>)

Multimeter (≥ 1100 Vdc)



Slotted screwdriver (M2)

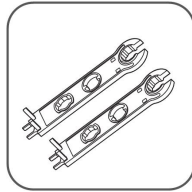

MC4 terminal wrench

#### 4.4 Moving the Inverter

Before installation, remove the inverter from the packing case and move it to the installation site. Follow the instructions below as you move the inverter:

- Always be aware of the weight of the inverter.
- Lift the inverter using the handles positioned on both sides of the inverter.
- Move the inverter by one or two people or by using a proper transport tool.
- Do not release the equipment unless it has been firmly secured.

#### 4.5 Installing the Inverter

Inverter is installed on the wall by means of wall-mounting bracket and the expansion plug sets.

The expansion plug set shown below is recommended for the installation.

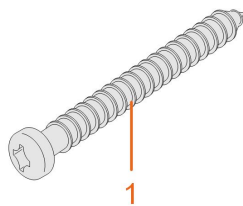

1

(1) Self-tapping screw M6

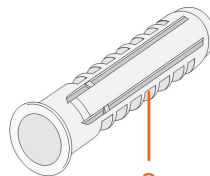

2

(2) Expansion tube

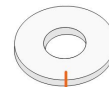

3

(3) Fender washer



4

(4) Spring washer

- step 1 Place the wall-mounting bracket to a proper position on the wall. Observe the level on the bracket and adjust until the bubble is in the middle position. Mark the positions and drill the holes.

**NOTICE**

The depth of the holes should be about 70 mm.

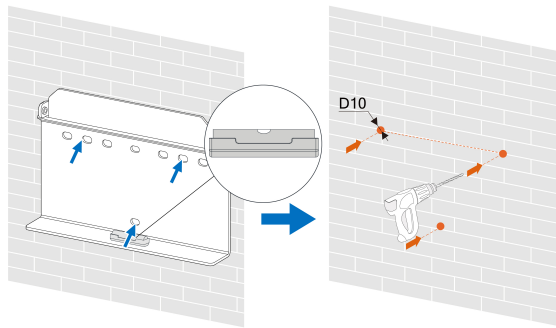

\* The image shown here is for reference only. The actual product received may differ.

- step 2 Place the expansion tubes into the holes. Then secure the wall-mounting bracket to the wall firmly with the expansion bolt sets.

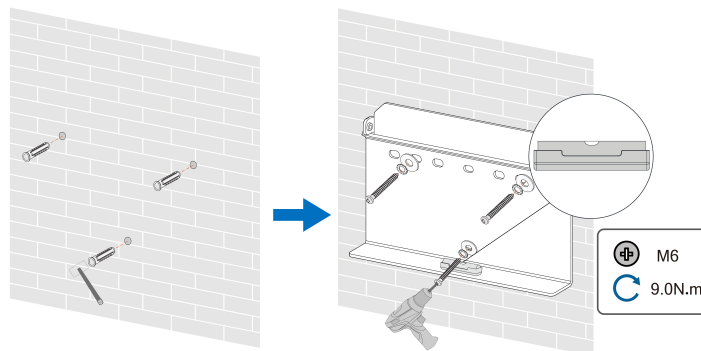

- step 3 Lift the inverter and slide it down along the wall-mounting bracket to make sure they match perfectly. Use the fastener set to lock the device.

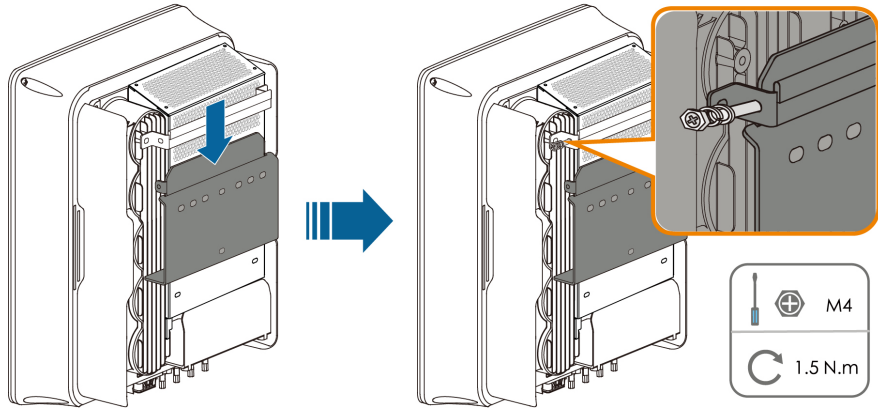

-- End

# 5 Electrical Connection

## 5.1 Safety Instructions

Prior to any electrical connections, keep in mind that the inverter has dual power supplies. It is mandatory for the qualified personnel to wear personal protective equipments (PPE) during the electrical work.

### DANGER

**Danger to life due to a high voltage inside the inverter!**

- **The PV string will generate lethal high voltage when exposed to sunlight.**
- **Before starting electrical connections, disconnect the DC switch and AC circuit breakers and prevent them from inadvertent reconnection.**
- **Ensure that all cables are voltage free before performing cable connection.**

### WARNING

- **Any improper operations during cable connection can cause device damage or personal injury.**
- **Only qualified personnel can perform cable connection.**
- **All cables must be undamaged, firmly attached, properly insulated and adequately dimensioned.**

### NOTICE

**Comply with the safety instructions related to the PV strings and the regulations related to the utility grid.**

- **All electrical connections must be in accordance with local and national standards.**
- **Only with the permission of the local utility grid company, the inverter can be connected to the utility grid.**

## 5.2 Terminal Description

All electrical terminals are located at the bottom of the inverter.

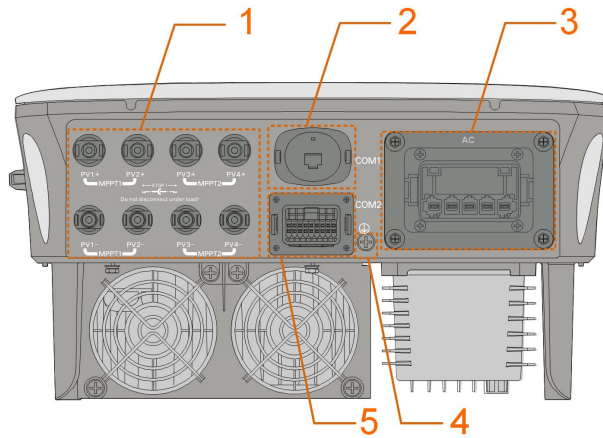

**figure 5-1** Terminals (SG20RT for example)

\* The image shown here is for reference only. The actual product received may differ.

table 5-1 Terminal Description

No.	Name	Description	Decisive Voltage Classification
1	PV1+, PV1-, PV2+, PV2-, PV3+, PV3-, PV4+, PV4-	MC4 terminals for PV input. The terminal number depends on inverter model.	DVC-C
2	COM1	Communication accessory port to be connected to WiNet-S for countries except Brazil or to WiFi for Brazil.	DVC-A
3	AC	AC terminal to connect to the grid.	DVC-C
4		Additional grounding terminal.	Not applicable
5	COM2	Communication connection for DI/DRM, DO, Logger and smart energy meter.	DVC-A

The pin definition of COM2 terminal is shown in the following label.

RSD		NS		DRM			RS485-1	DO
RSD-1	RSD-2	NS-1	NS-2	D1/5	D3/7	R	A1	NO
B3	A3	B2	A2	D2/6	D4/8	C	B1	COM
RS485-3		Meter						

figure 5-2 Label of COM2 Terminal

table 5-2 Label Description of COM2 Terminal

Label	Description	
RSD	RSD-1, RSD-2	Reserved
NS	NS-1, NS-2	For inverter emergency stop
DRM	D1/5, D2/6, D3/7, D4/8,	For external Demand Response Enabling Device ("AU"/ "NZ")
	R, C	For Ripple Control
RS485-1	A1, B1	For inverter daisy chain (Cannot be used simultaneously with COM1 port for WiNet-S)
DO	NO, COM	External alarm interface, e.g. light indicator and/or buzzer The external DC voltage should not be higher than 30 V and the current not higher than 1 A.
RS485-3	A3, B3	Reserved
Meter	A2, B2	Smart energy meter interface

### 5.3 Electrical Connection Overview

The electrical connection should be realized as follows:

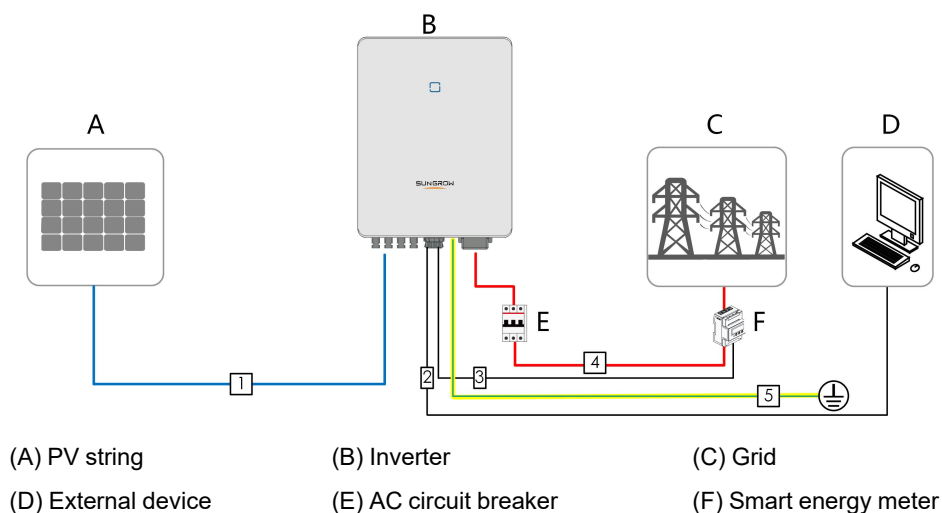

table 5-3 Cable Requirements

No.	Cable	Type	Cable Diameter	Wire Conductor Cross-section
1	DC cable	Outdoor multi-core copper wire cable complying with 1100 V and 30 A standard	6 mm–9 mm	4 mm <sup>2</sup> –6 mm <sup>2</sup>
2	Ethernet cable	CAT 5E outdoor shielded network cable	5.3 mm–7 mm	8 * 0.2 mm <sup>2</sup>
3	Meter RS485 cable (1)	Shielded twisted pair	5.3 mm–7 mm	2 * (0.5–1.0) mm <sup>2</sup>
4	AC cable (2)	Outdoor 5-core copper wire cable	SG3.0RT to SG12RT : 10 mm–21 mm SG15RT to SG20RT : 14 mm–25 mm	SG3.0RT to SG12RT : 4 mm <sup>2</sup> –6 mm <sup>2</sup> SG15RT to SG20RT : 6 mm <sup>2</sup> –10 mm <sup>2</sup>
5	Additional Grounding cable	Outdoor single-core copper wire cable	The same as that of the PE wire in the AC cable	

(1) The cable requirements for **COM2** terminal connection are the same.

(2) All the AC wires should be equipped with correctly colored cables for distinguishing. Please refer to related standards about the wiring color.

## 5.4 External Grounding Connection

### WARNING

- Since the inverter is transformerless, neither the negative pole nor the positive pole of the PV string can be grounded. Otherwise, the inverter will not operate normally.
- Connect the external grounding terminal to the protective grounding point before AC cable connection, PV cable connection, and communication cable connection.
- The ground connection of this external grounding terminal cannot replace the connection of the PE terminal of the AC cable. Make sure those terminals are both grounded reliably. Otherwise, SUNGROW shall not be held liable for any damage caused by the violation.

### 5.4.1 External Grounding Requirements

All non-current carrying metal parts and device enclosures in the PV power system should be grounded, for example, brackets of PV modules and inverter enclosure.

When there is only one inverter in the PV system, connect the external grounding cable to a nearby grounding point.

When there are multiple inverters in the PV system, connect grounding points of all inverters and the PV array frames to the equipotential cable (according to the onsite conditions) to implement an equipotential connection.

### 5.4.2 Connection Procedure

Additional grounding cable and OT/DT terminal are prepared by customers.

step 1 Prepare the cable and OT/DT terminal.

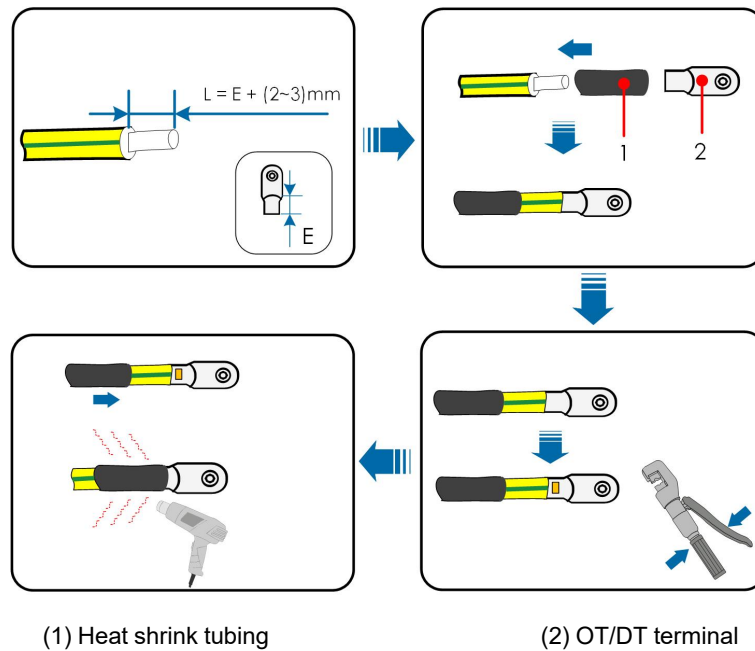

step 2 Remove the screw on the grounding terminal and fasten the cable with a screwdriver.



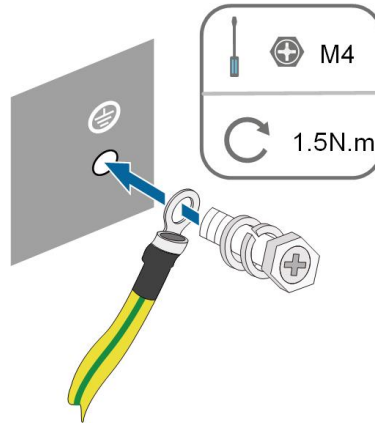

step 3 Apply paint to the grounding terminal to ensure corrosion resistance.

-- End

## 5.5 AC Cable Connection

### 5.5.1 AC Side Requirements



Connect the inverter to the grid only after getting an approval from the local electric power company.

Before connecting the inverter to the grid, ensure the grid voltage and frequency comply with requirements, for which, refer to "**Technical Data**". Otherwise, contact the electric power company for help.

#### AC Circuit Breaker

An independent three or four-pole circuit breaker must be installed on the output side of the inverter to ensure safe disconnection from the grid. The recommended specifications are as follows.

Inverter Model	Recommended Specification
SG3.0RT/SG4.0RT/SG5.0RT/ SG6.0RT	16 A
SG7.0RT/SG8.0RT	20 A
SG10RT	25 A
SG12RT	32 A
SG15RT/SG17RT	40 A
SG20RT	50 A

**NOTICE**

- **Determine whether an AC circuit breaker with greater overcurrent capacity is required based on actual conditions.**
- **Multiple inverters cannot share one circuit breaker.**
- **Never connect a load between the inverter and the circuit breaker.**

**Residual Current Monitoring Device**

With an integrated universal current-sensitive residual current monitoring unit included, the inverter will disconnect immediately from the mains power once a fault current with a value exceeding the limit is detected.

However if an external residual current device (RCD) (type A is recommended) is mandatory, the switch must be triggered at a residual current of 300 mA (recommended). RCD of other specifications can also be used according to local standard.

In Australia, a RCD is not required according to the local standard AS3000-2018 when either of the following installation methods is adopted if the PV array capacitance to ground is large (such as a tin roof):

- Use heavy duty conduits ( such as metal bushing ) when run PV and AC cables through Cavity walls.
- Route the PV and AC cables through pipes (PVC or metal tubing), lay the cables and install them.

**Multiple Inverters in parallel Connection**

If multiple inverters are connected in parallel to the grid, ensure that the total number of parallel inverters does not exceed 5. Otherwise, please contact SUNGROW for technical scheme.

**5.5.2 Assembling the AC Connector (< 15 kW)**

The AC terminal block is on the bottom side of the inverter. AC connection is the three-phase-four-wire grid + PE connection (L1, L2, L3, N, and PE).

step 1 Unscrew the swivel nut of the AC connector.

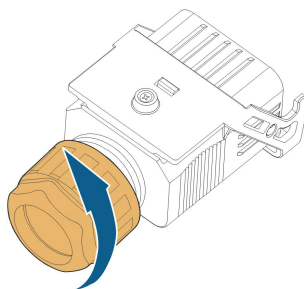

step 2 Take out the spring-loaded terminal from the housing.

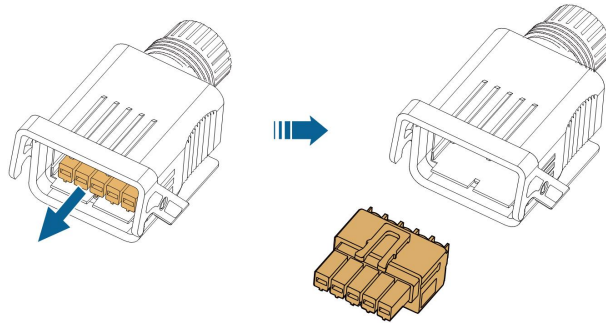

step 3 Thread the AC cable of appropriate length through the swivel nut, the sealing ring and the housing.

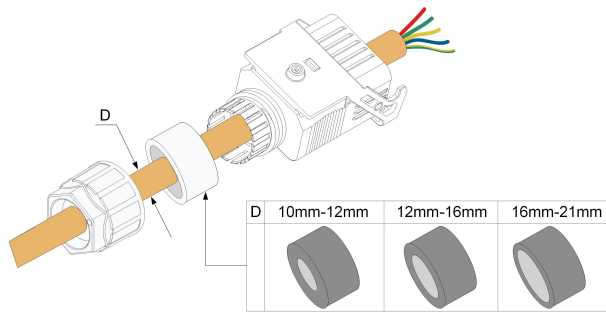

step 4 Remove 45 mm of the cable jacket and 12 mm–16 mm of the wire insulation.

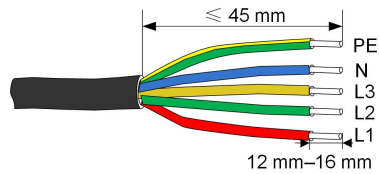

step 5 Open the clamp on the spring-loaded terminal and insert the wires into the corresponding holes. Close the clamp and push the terminal into the housing until there is an audible click.

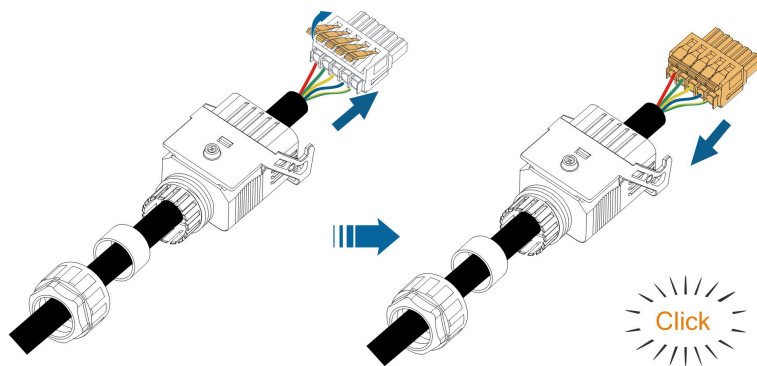

**NOTICE**

**Observe the terminal assignment. Do not connect any phase line to the "PE" terminal or PE wire to "N" terminal. Otherwise, unrecoverable damage to the inverter may follow.**

- step 6 Ensure that the wires are securely in place by slightly pulling them. Tighten the swivel nut to the housing.

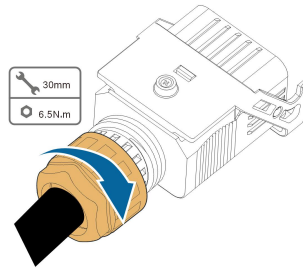

-- End

### 5.5.3 Installing the AC Connector (< 15 kW)

**⚠ DANGER**

**High voltage may be present in inverter!**  
**Ensure all cables are voltage-free before electrical connection.**  
**Do not connect the AC circuit breaker until all inverter electrical connections are completed.**

- step 1 Disconnect the AC circuit breaker and secure it against reconnection.  
 step 2 Remove the waterproof lid from the **AC** terminal.

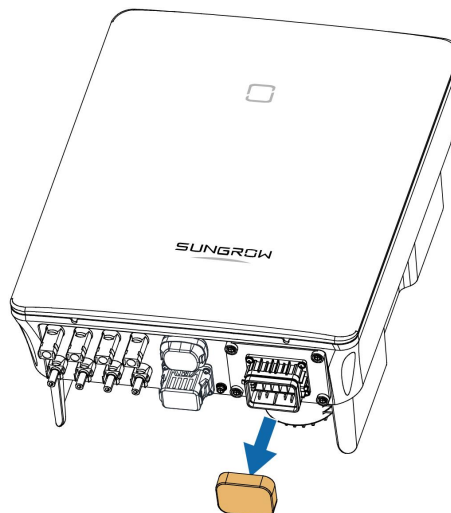

- step 3 Lift the locking part upwards and insert the AC connector into the **AC** terminal on the bottom side of the inverter. Then press the locking part and secure it with the screw.

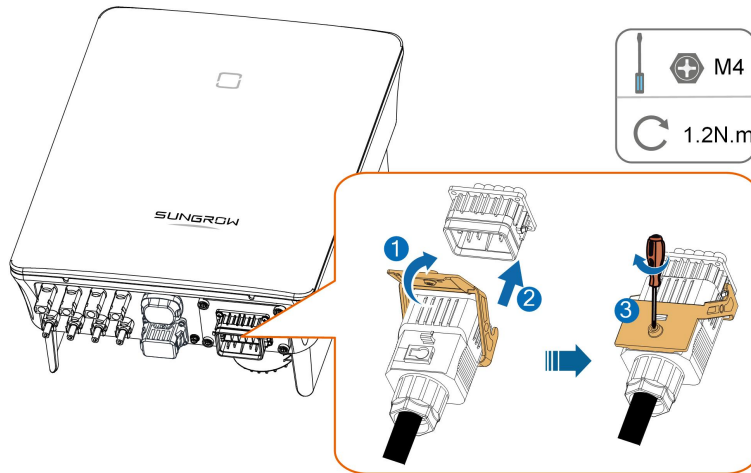

- step 4 Connect the PE wire to ground and the phase lines and the “N” line to AC circuit breaker. Then Connect the AC circuit breaker to electric board.

- step 5 Make sure all wires are firmly installed via the right torque tool or dragging the cables slightly.

-- End

#### 5.5.4 Assembling the AC Connector (≥ 15 kW)

The AC terminal block is on the bottom side of the inverter. AC connection is the three-phase-four-wire grid + PE connection (L1, L2, L3, N, and PE).

- step 1 Unscrew the swivel nut of the AC connector.

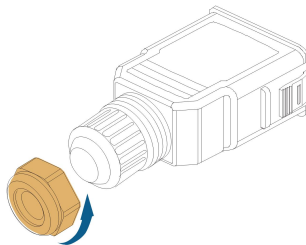

- step 2 (Optional) Remove the inner sealing ring if the cable diameter is 19 mm–25 mm. Otherwise skip this step.

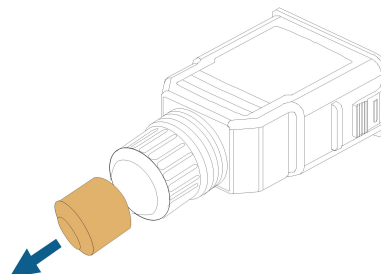

step 3 Take out the screw-type terminal plug from the housing.

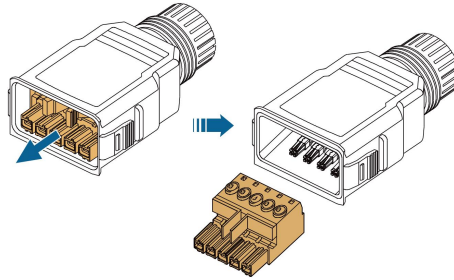

step 4 Thread the AC cable of appropriate length through the swivel nut and the housing.

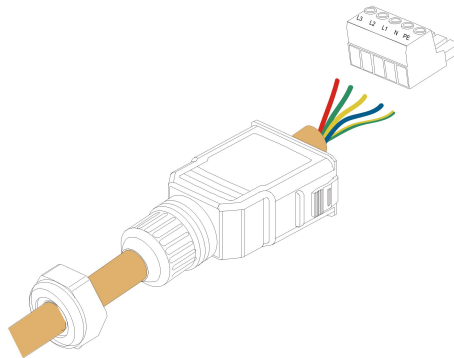

step 5 Remove 80 mm–90 mm of the cable jacket and 12 mm of the wire insulation.

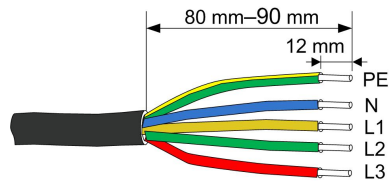

step 6 **(Optional)** When using a multi-core multi-strand copper wire cable, connect the AC wire head to the cord end terminal (hand-tight). In case of single-strand copper wire, skip this step.

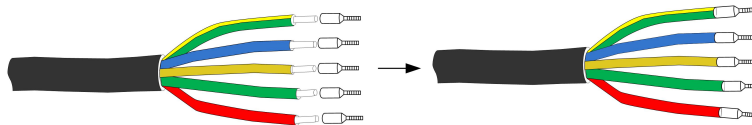

step 7 Fix all the wires to the screw-type terminal according to the assignment and tighten to a torque of 1.2 N•m–1.5 N•m with a screwdriver. Then push the terminal into the housing until there is an audible click.

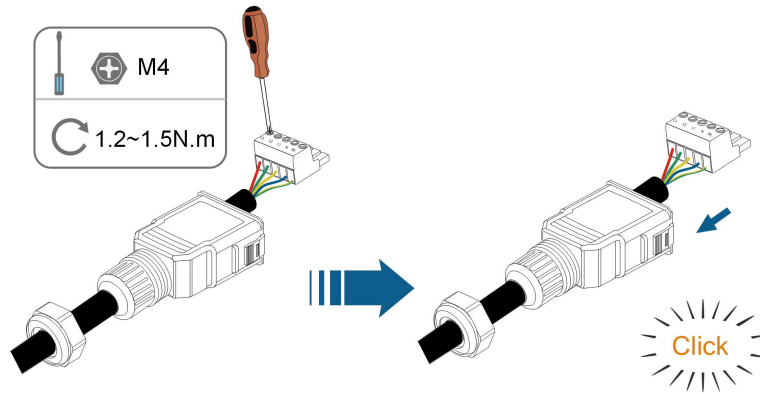
**NOTICE**

**Observe the terminal assignment. Do not connect any phase line to the "PE" terminal or PE wire to "N" terminal. Otherwise, unrecoverable damage to the inverter may follow.**

step 8 Ensure that the wires are securely in place by slightly pulling them. Tighten the swivel nut to the housing.

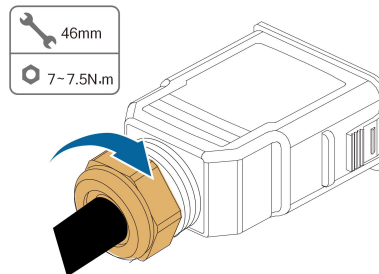

-- End

### 5.5.5 Installing the AC Connector ( $\geq 15$ kW)

**⚠ DANGER**

**High voltage may be present in inverter!**

**Ensure all cables are voltage-free before electrical connection.**

**Do not connect the AC circuit breaker until all inverter electrical connections are completed.**

step 1 Disconnect the AC circuit breaker and secure it against reconnection.

step 2 Remove the waterproof lid from the **AC** terminal.

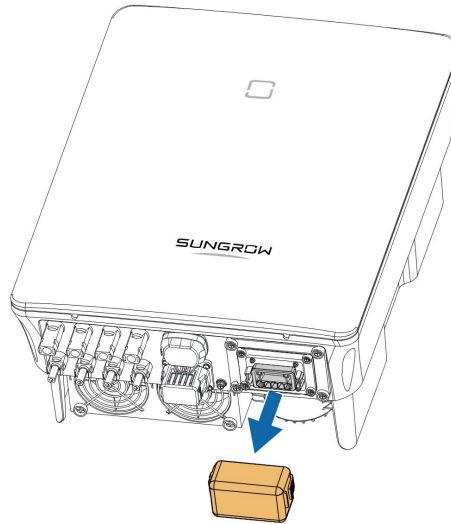

step 3 Insert the AC connector into the **AC** terminal on the bottom of the inverter until there is an audible sound.

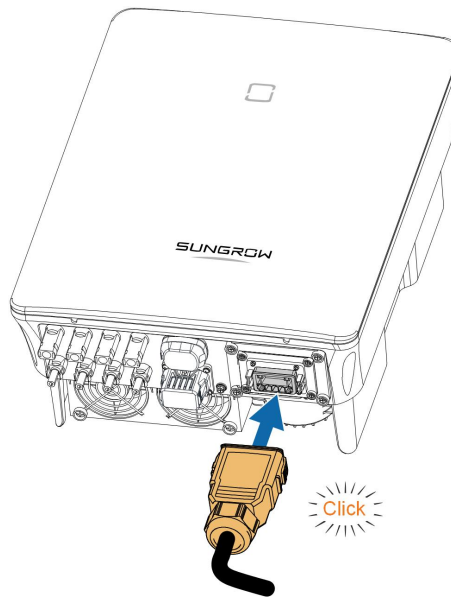

step 4 **(Optional)** Secure the AC connector, as shown in the figure below.



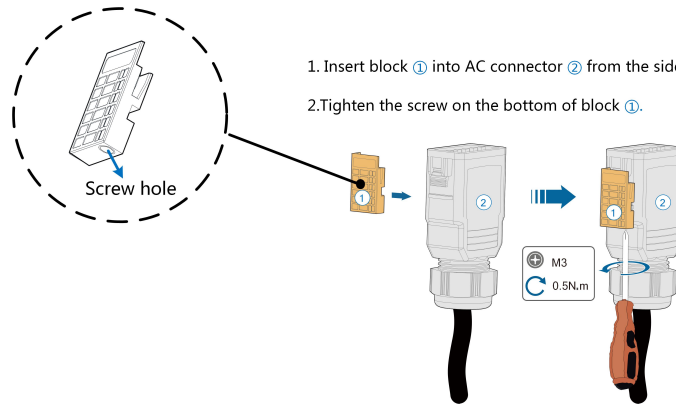

step 5 Connect the PE wire to ground and the phase lines and the "N" line to AC circuit breaker. Then connect the AC circuit breaker to electric board.

step 6 Make sure all wires are firmly installed via the right torque tool or dragging the cables slightly.

-- End

## 5.6 DC Cable Connection

### **⚠ DANGER**

**Danger of electric shock!**

**The PV array will generate lethal high voltage once exposed to sunlight.**

### **⚠ WARNING**

**Make sure the PV array is well insulated to ground before connecting it to the inverter.**

**During the installation and operation of the inverter, please ensure that the positive or negative polarities of PV strings do not short-circuit to the ground. Otherwise, an AC or DC short-circuit may occur, resulting in equipment damage. The damage caused by this is not covered by the warranty.**

**NOTICE**

**Risk of inverter damage! Observe the following requirements. Failure to do so will void guarantee and warranty claims.**

- **Make sure the maximum DC voltage and the maximum short circuit current of any string never exceed inverter permitted values specified in "Technical Data".**
- **Mixed use of different brand or model of PV modules in a PV string or a compromised PV string design composed with PV modules from rooftops of different orientation may not damage inverter but will cause system bad performance!**
- **The inverter enters standby state when the input voltage ranges between 1,000 V and 1,100 V. The inverter returns to running state once the voltage returns to the MPPT operating voltage range, namely, 160 V to 1,000 V.**

### 5.6.1 PV Input Configuration

- The inverters SG3.0RT/SG4.0RT/SG5.0RT/SG6.0RT have two PV inputs, SG7.0RT/SG8.0RT/SG10RT/SG12RT have three PV inputs and SG15RT/SG17RT/SG20RT have four PV inputs.
- The inverters have two MPP trackers. Each DC input area can operate independently.
- The PV strings to the same DC input area should have the same type, the same number of PV panels, identical tilt and identical orientation for maximum power.
- The PV strings to two DC input areas may differ from each other, including PV module type, number of PV modules in each string, angle of tilt, and installation orientation.

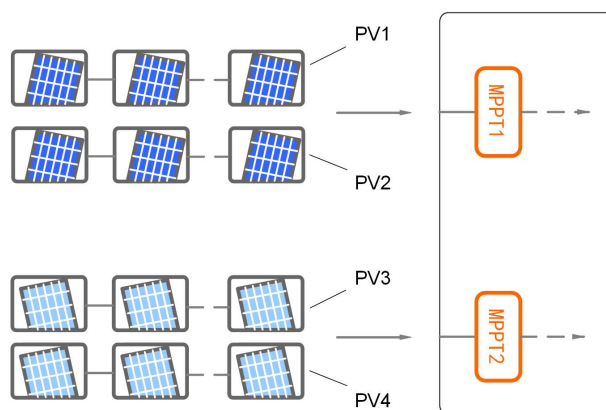

**figure 5-3** PV Input Configuration (SG20RT for example)

Prior to connecting the inverter to PV inputs, the specifications in the following table should be met:

Inverter Model	Open-circuit Voltage Limit	Max. current for input connector
All models	1100 V	30 A

The following figure shows the open-circuit voltage limits at different altitudes. Before configuring the PV panels, need to take this derating curve in consideration under high altitude situation.

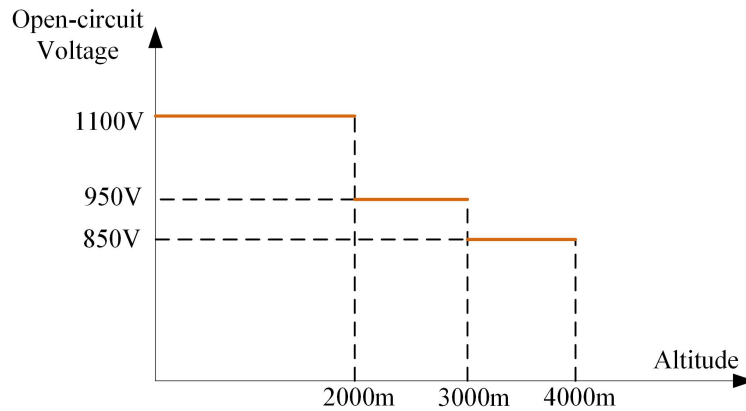

figure 5-4 Open-circuit Voltage Derating Curve

## 5.6.2 Assembling the PV Connectors

### **⚠ DANGER**

**High voltage may be present in the inverter!**

- **Ensure all cables are voltage-free before performing electrical operations.**
- **Do not connect the AC circuit breaker before finishing electrical connection.**

### **⚠ CAUTION**

- **Use MC4 DC terminals if the maximum input voltage is no more than 1,000 V.**
- **Use MC4-Evo2 DC terminals if the maximum input voltage is greater than 1,000 V. To purchase the MC4-Evo2 DC terminals, contact SUNGROW.**
- **Select appropriate DC terminals as required above. Otherwise, SUNGROW shall be held no liability for the damage caused.**



SUNGROW provides corresponding PV connectors in the scope of delivery for quick connection of PV inputs. To ensure IP65 protection, use only the supplied connector or the connector with the same ingress of protection.

step 1 Strip 7 mm–8 mm of the insulation from each PV cable.

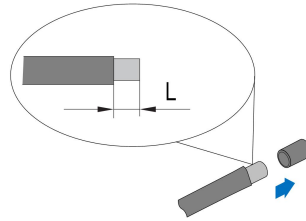

step 2 Assemble the cable ends with the crimping pliers.

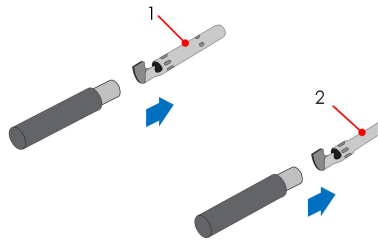

1: Positive crimp contact

2 : Negative crimp contact

step 3 For some countries such as Australia where the DC protection cover delivered separately need to be installed on site, please firstly lead the PV cables through the waterproof terminal on the DC protection cover before assembling the connector. See the guidance with the DC protection cover for details.

#### NOTICE

**PV cables with connectors cannot go through the waterproof terminal on the DC protection cover. Rework may cause damage to the connectors, which will not be covered by the warranty.**

step 4 Lead the cable through cable gland, and insert the crimp contact into the insulator until it snaps into place. Gently pull the cable backward to ensure firm connection. Tighten the cable gland and the insulator (torque 2.5 N.m to 3 N.m).

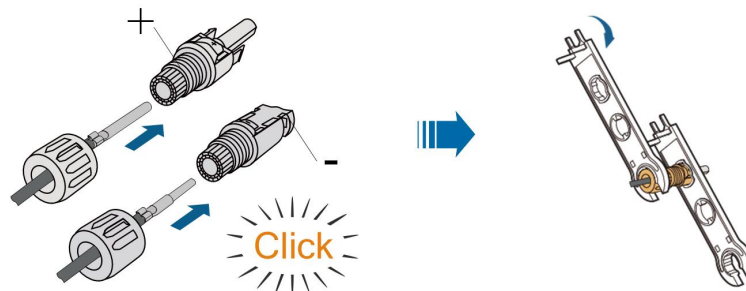

step 5 Check for polarity correctness.

**NOTICE**

**If the PV polarity is reversed, the inverter will be in a fault or alarm state and will not operate normally.**

-- End

### 5.6.3 Installing the PV Connectors

step 1 Rotate the DC switch to "OFF" position.

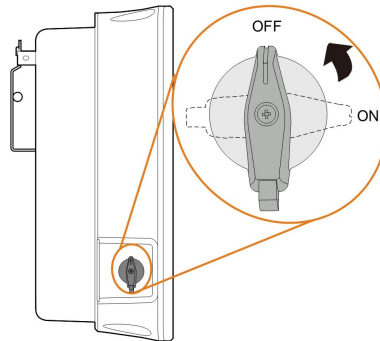

step 2 Check the cable connection of the PV string for polarity correctness and ensure that the open circuit voltage in any case does not exceed the inverter input limit of 1,100 V.

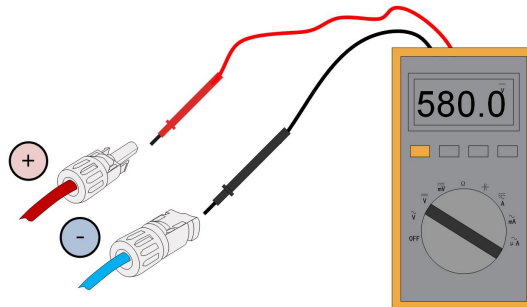

step 3 Connect the PV connectors to corresponding terminals until there is an audible click.

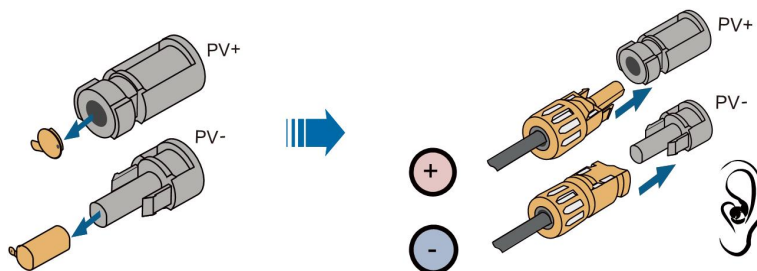

S005-E046

**NOTICE**

- **Check the positive and negative polarity of the PV strings, and connect the PV connectors to corresponding terminals only after ensuring polarity correctness.**
- **Electric arc or contactor overtemperature may occur if the PV connectors are not firmly in place, and SUNGROW shall not be held liable for any damage caused due to this operation.**

step 4 Seal the unused PV terminals with the terminal caps.

-- End

## 5.7 WiNet-S Connection

The WiNet-S module supports Ethernet communication and WLAN communication. It is not recommended to use both communication methods at the same time.

The WiNet-S communication for Ethernet cannot be used simultaneously with A1 and B1 terminals for RS485 daisy chain.

For details, see the quick guide for the WiNet-S module. Scan the following QR code for the quick guide.



### 5.7.1 Ethernet Communication

The WiNet-S communication for Ethernet cannot be used simultaneously with A1 and B1 terminals for RS485 daisy chain.

step 1 **(Optional)** Strip the insulation layer of the communication cable with an Ethernet wire stripper, and lead the corresponding signal cables out. Insert the stripped communication cable into the RJ45 plug in the correct order, and crimp it with a crimper.

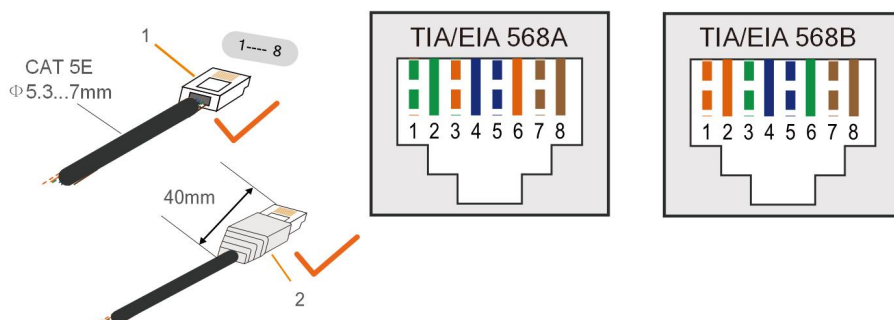

1: RJ45 plug

2 : Protective cap



Skip this step if a standard network cable with RJ45 plug is prepared.

step 2 Unscrew the swivel nut from the communication module and take out the inner sealing ring.

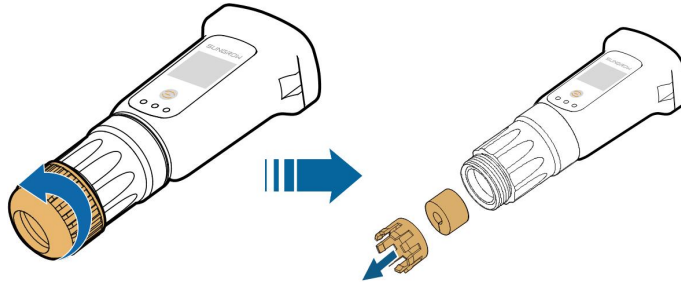

step 3 Unscrew the housing from the communication module.

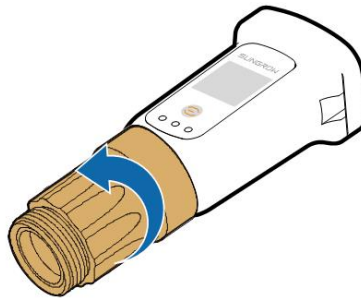

step 4 Thread the network cable through the swivel nut and gasket. Afterwards, route the cable into the opening of the sealing. Finally, insert the cable through the housing.

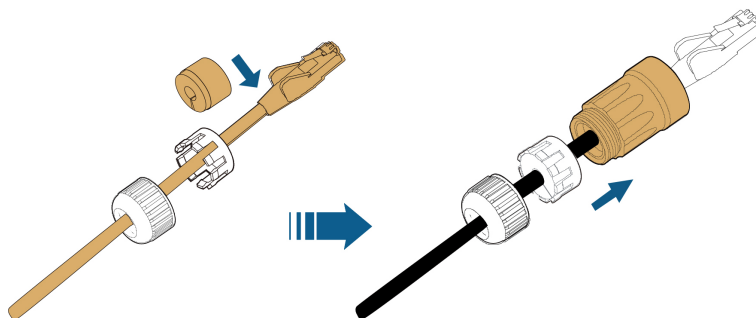

step 5 Insert the RJ45 plug into the front plug connector until there is an audible click and tighten the housing. Install the gasket and fasten the swivel nut.

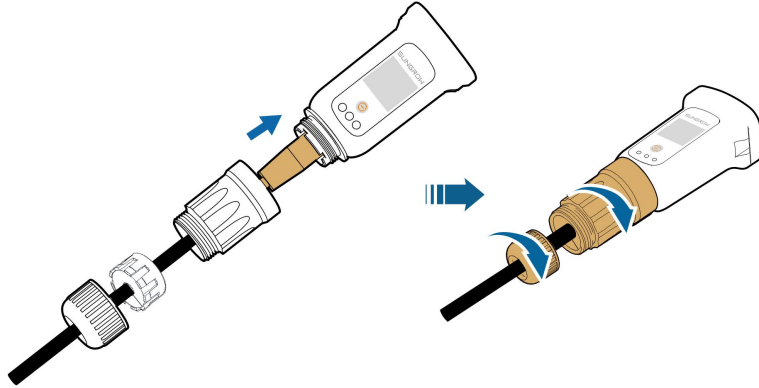

step 6 Remove the waterproof lid from the **COM1** terminal and install WiNet-S.

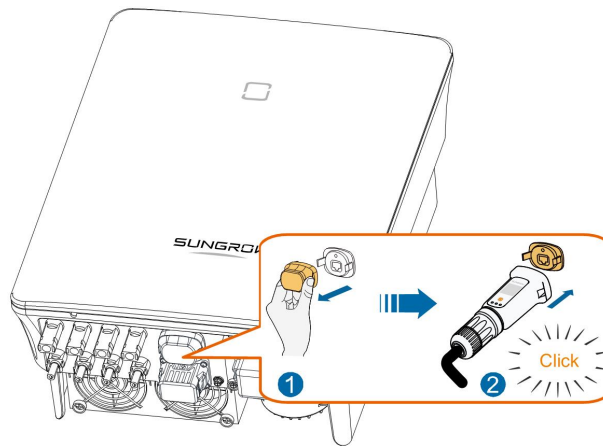

step 7 Slightly shake it by hand to determine whether it is installed firmly.

-- End

### 5.7.2 WLAN Communication

step 1 Remove the waterproof lid from the **COM1** terminal.

step 2 Install the module. Slightly shake it by hand to determine whether it is installed firmly, as shown below.



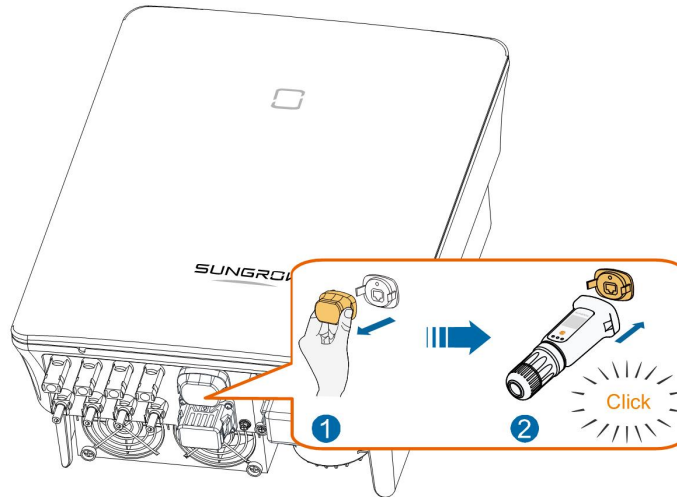

step 3 Refer to the guide delivered with the module for the set-up.

-- End

## 5.8 WiFi Connection (for Brazil)

step 1 Remove the waterproof lid from the **COM1** terminal.

step 2 Install the module. Slightly shake it by hand to determine whether it is installed firmly, as shown below.

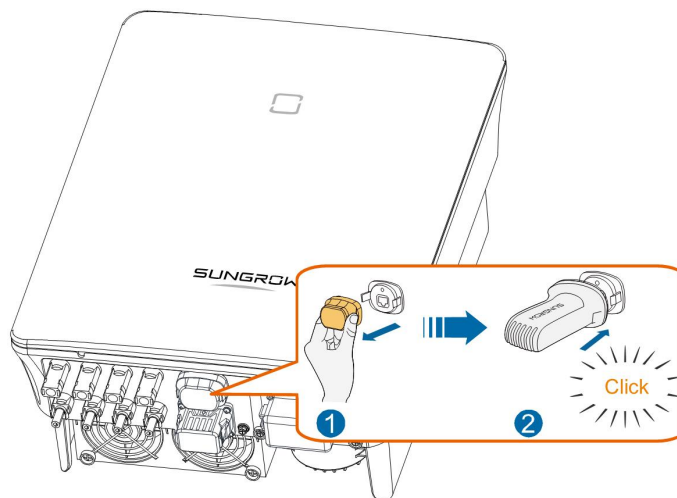

step 3 Refer to the guide delivered with the module for the set-up.

-- End

## 5.9 Meter Connection

In a single inverter scenario, the Meter (A2, B2) terminals are designed to connect to the Smart Energy Meter for the feed-in power function.

### 5.9.1 Assembling the COM Connector

step 1 Unscrew the swivel nut from the connector.

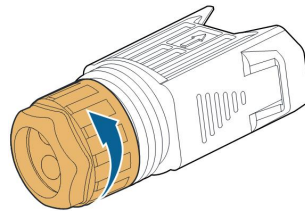

step 2 Take out the terminal block.

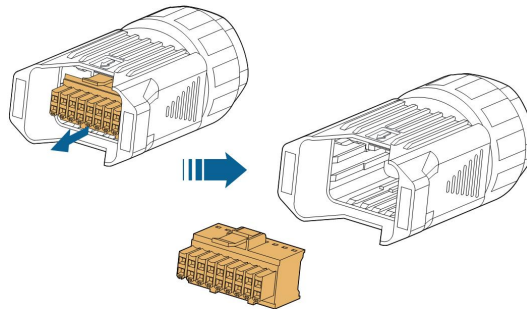

step 3 Remove the seal and lead the cable through the cable gland.

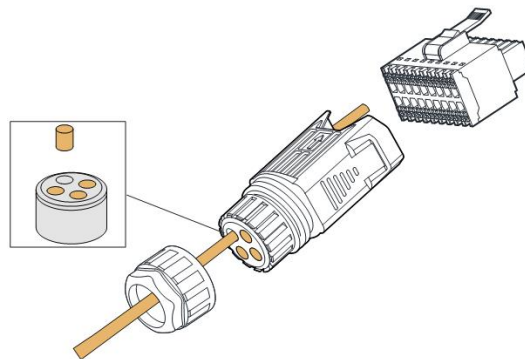

step 4 Remove the cable jacket and strip the wire insulation.

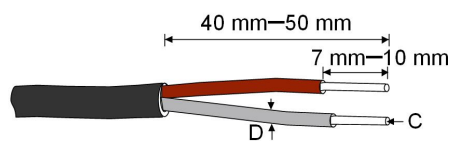

$$C = 0.5 \text{ mm}^2 - 1.0 \text{ mm}^2, D \leq 2.8 \text{ mm}$$

step 5 (Optional) When using a multi-core multi-strand wire cable, connect the wire head to the cord end terminal. In case of single-strand copper wire, skip this step.

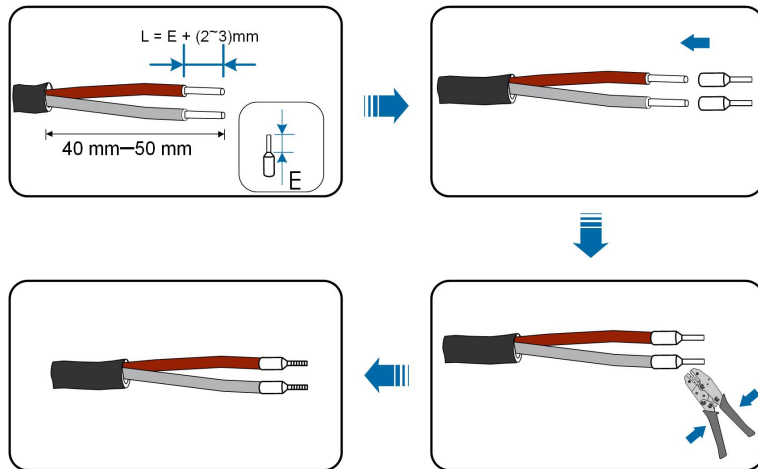

step 6 Plug the wires or terminals into the corresponding terminals as shown in the following figure.

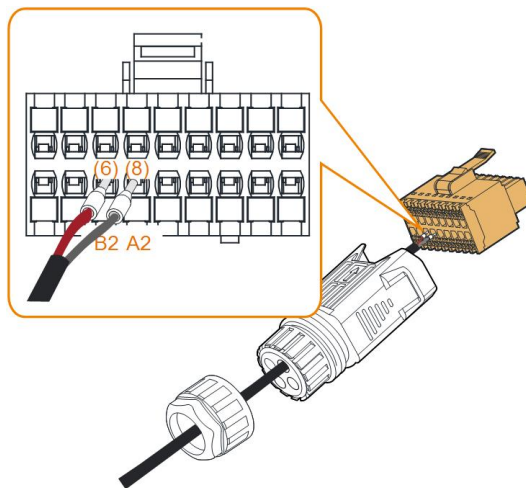
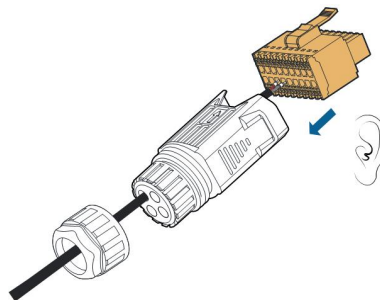
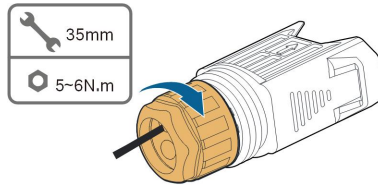

figure 5-5 A2, B2 connection

step 7 Ensure that the wires are securely in place by slightly pulling them and insert the terminal plug into the housing until there is an audible click.



step 8 Fasten the swivel nut.



-- End

### 5.9.2 Installing the COM Connector

step 1 Remove the waterproof lid from the **COM2** connector.

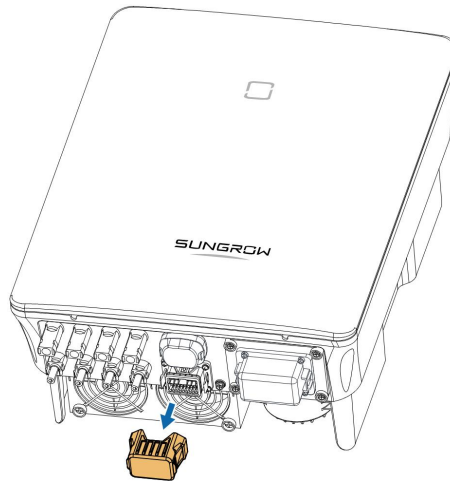

step 2 Insert the COM connector into **COM2** terminal on the bottom of the inverter until there is an audible click.

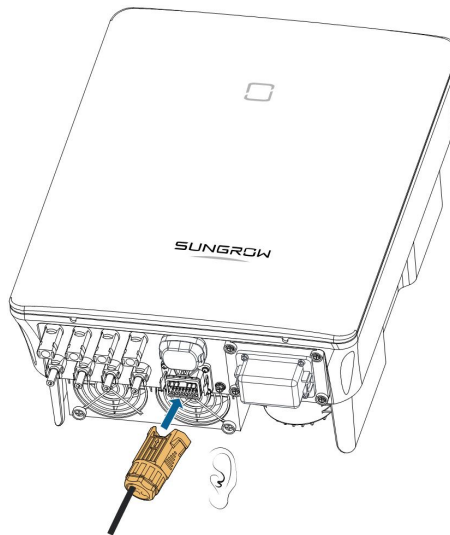

-- End

## 5.10 RS485 Connection

### 5.10.1 RS485 Communication System

The RS485 (A1, B1) connection can establish the communication between the inverter and an external device, as well as the communication between two inverters in parallel.

In case of multiple inverters, all the inverters can be connected via RS485 cables in daisy chain manner.

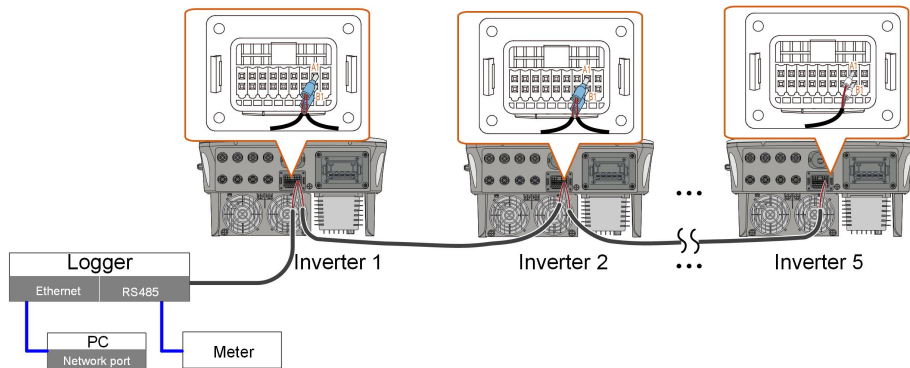

figure 5-6 Multi-inverter Connection



- The maximum number of inverters allowed to be connected in the same point of connection is 5.
- The RS485 communication cable should be shielded twisted pair cables or shielded twisted pair Ethernet cables.
- The RS485 cable between two devices should be not longer than 10 m.
- The RS485 communication cannot be used simultaneously with COM1 port for WiNet-S.
- Refer to the manual of Logger for the communication connection to the meter.

### 5.10.2 Assembling the COM Connector

step 1 Unscrew the swivel nut from the connector.

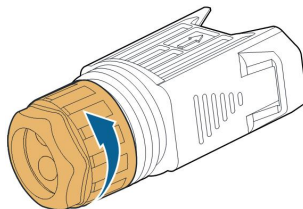

step 2 Take out the terminal block.

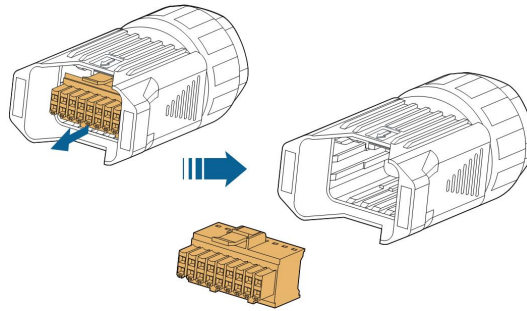

step 3 Remove the seal and lead the cable through the cable gland.

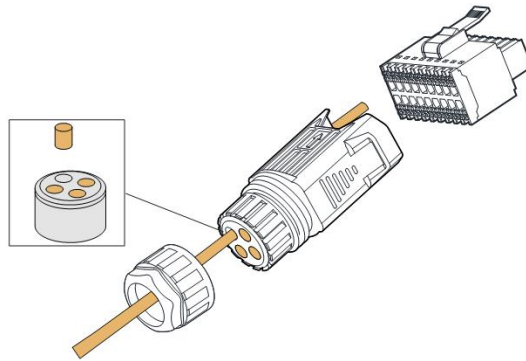

step 4 Remove the cable jacket and strip the wire insulation.

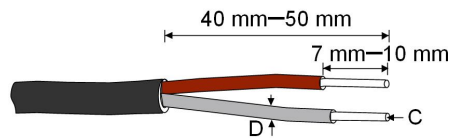

$$C = 0.5 \text{ mm}^2 - 1.0 \text{ mm}^2, D \leq 2.8 \text{ mm}$$

step 5 (Optional) When using a multi-core multi-strand wire cable, connect the wire head to the cord end terminal. In case of single-strand copper wire, skip this step.

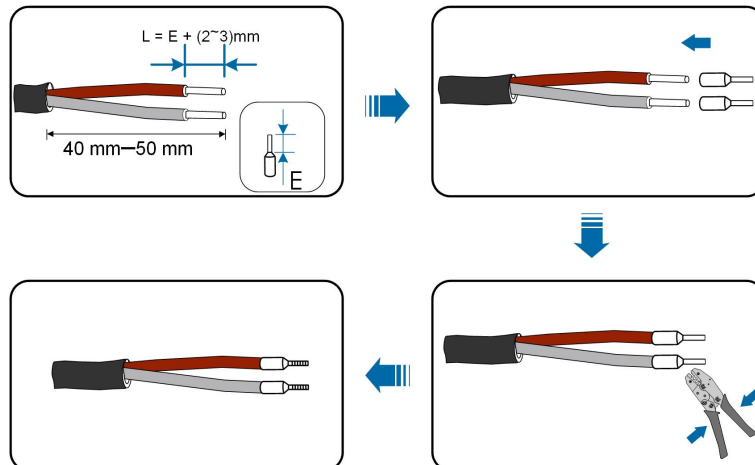

step 6 Plug the wires or terminals into the corresponding terminals as shown in the following figure.

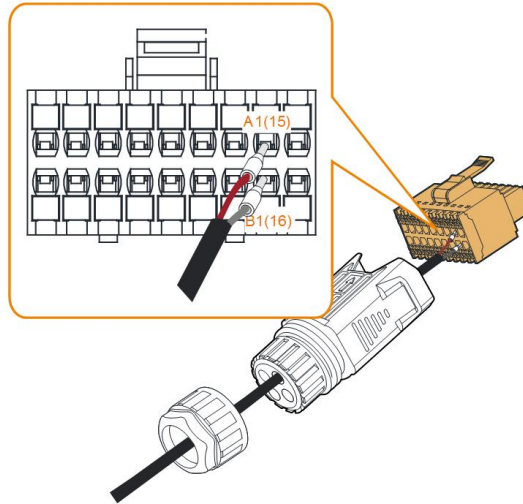
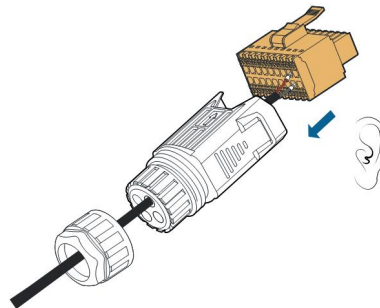

figure 5-7 A1, B1 connection

step 7 Ensure that the wires are securely in place by slightly pulling them and insert the terminal plug into the housing until there is an audible click.



step 8 **For RS485 daisy chain:** Crimp two wires A to a two-wire core end terminal and two wires B to another terminal. Plug the terminals to A1 and B1 respectively.

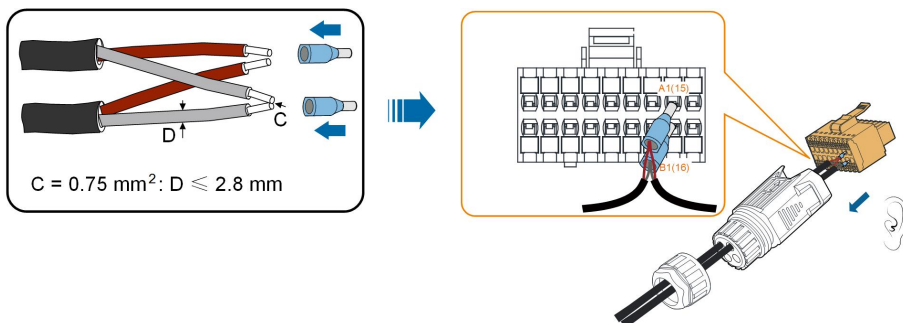
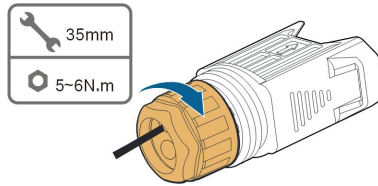

figure 5-8 RS485 daisy chain connection

step 9 Fasten the swivel nut.



-- End

### 5.10.3 Installing the COM Connector

step 1 Remove the waterproof lid from the **COM2** connector.

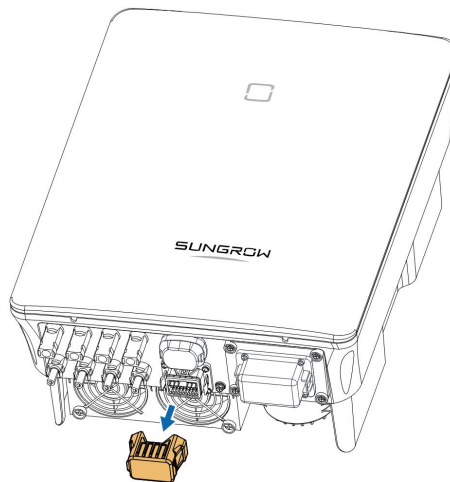

step 2 Insert the COM connector into **COM2** terminal on the bottom of the inverter until there is an audible click.

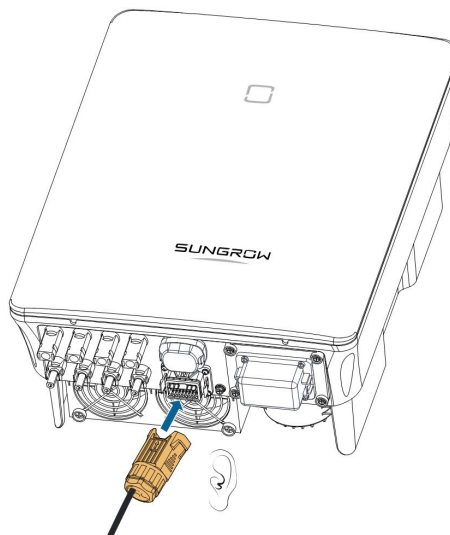

-- End



## 5.11 DO Connection

The inverter is equipped with a DO relay for an earth fault alarm. The additional equipment required is a light indicator and/or a buzzer that needs additional power supply. Once fault occurs, the relay trips and the circuit is connected. The external indicator gets on. The relay remains triggered until the fault is removed.

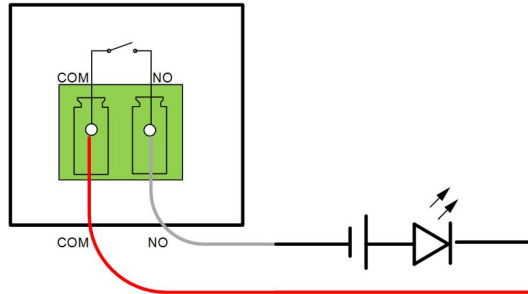
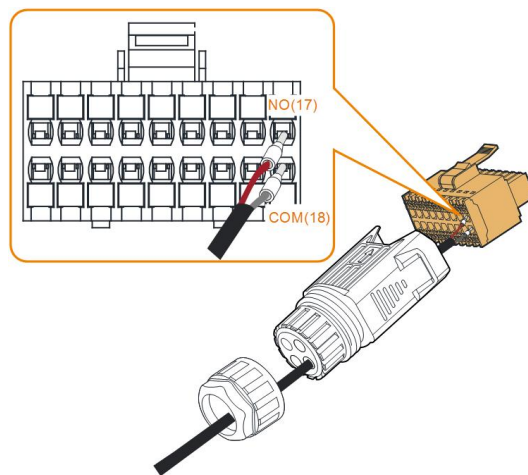

figure 5-9 DO Normal Open Connect

The additional DC power supply should comply with related requirements:

- Max. voltage: 30 V
- Max. current: 1 A

Refer to section ["5.9.1 Assembling the COM Connector"](#) for detailed assembling procedure. Plug the wires to **NO** and **COM** terminals according to the labels on the bottom of the inverter.



Refer to section ["5.10.3 Installing the COM Connector"](#) to install the connector.

## 5.12 DRM Connection

In Australia and New Zealand, the inverter supports the demand response modes as specified in the standard AS/NZS 4777.

The following figure shows the wiring between the inverter and the external DRED.

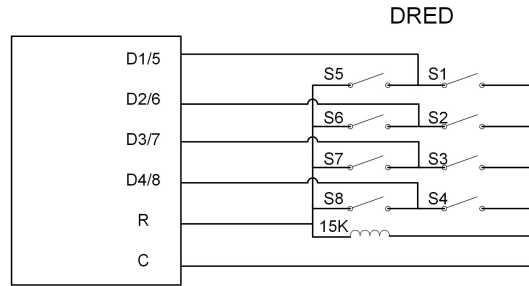
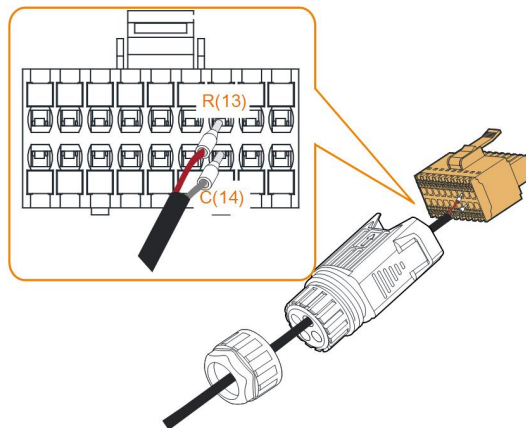

table 5-4 Method of Asserting DRM

Mode	Asserted by Shorting Terminals on Inverter	Switch Operation on External DRED
DRM0	R & C	Close S1 and S5

Refer to section "5.9.1 Assembling the COM Connector" for detailed assembling procedure. Plug the wires to **R** and **C** terminals according the labels on the bottom of the inverter.



Refer to section "5.10.3 Installing the COM Connector" to install the connector.

## 5.13 DI Connection

The grid company uses a Ripple Control Receiver to convert the grid dispatching signal and send it as a dry contact signal.

The following figure shows the wiring between the inverter and the ripple control receiver.

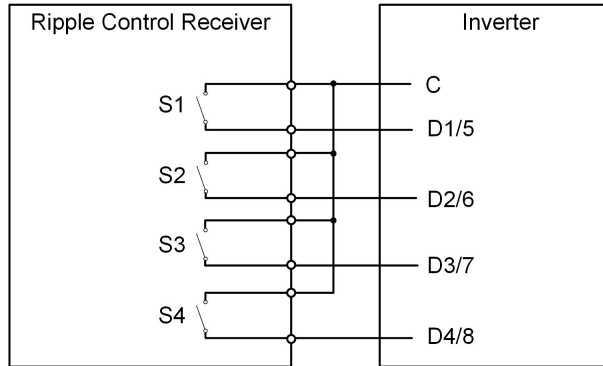
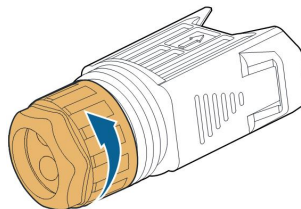

table 5-5 Method of Asserting DI Mode

S-1	S2	S3	S4	Switch Operation on External RCR	Output power (in % of the Rated AC output power)
0	0	0	0	None	100 % (configurable according to need)
1	0	0	0	Close S1	100 %
0	1	0	0	Close S2	60 %
0	0	1	0	Close S3	30 %
1	1	0	0	Close S1 and S2	0 % (disconnect from grid)

step 1 Unscrew the swivel nut from the connector.



step 2 Take out the terminal block.

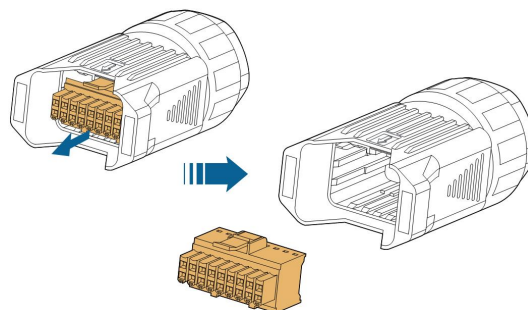

step 3 Remove the seal and lead the cable through the cable gland.

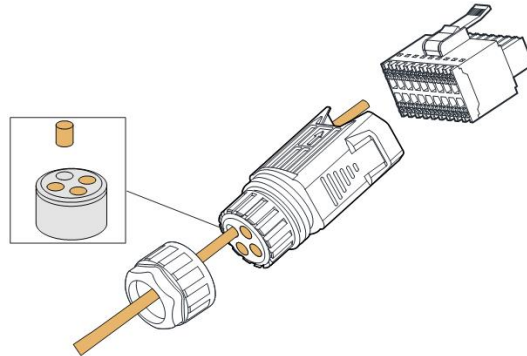

step 4 Remove the cable jacket by 7 mm–10 mm.

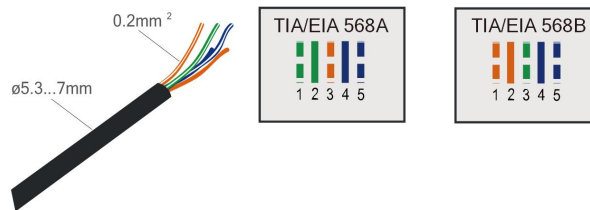

step 5 Plug the wires into the corresponding terminals as shown in the following figure.

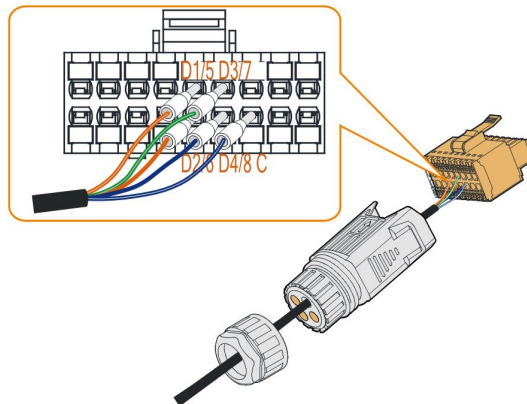
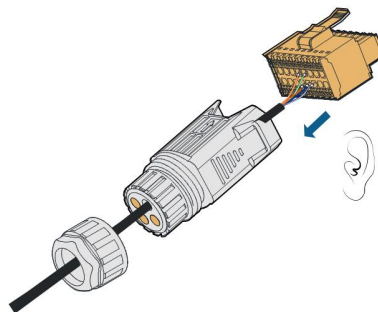
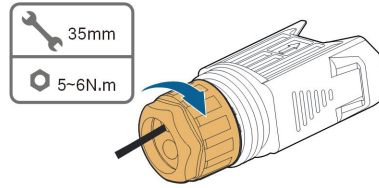

figure 5-10 DI connection

step 6 Ensure that the wires are securely in place by slightly pulling them and insert the terminal plug into the housing until there is an audible click.



step 7 Fasten the swivel nut.



step 8 Refer to section "[5.10.3 Installing the COM Connector](#)" to install the connector.

-- End

## 5.14 NS Protection Connection

NS terminal: NS Protection is used for the German market currently. For plants sized more than 30kVA, inverter NS Protection terminals could be used in daisy chain to external NS Protection Relay to realize emergency stop when the NS Protection Relay changes its dry contact status due to the grid abnormal running status. For detailed assembling procedure for inverters in daisy chain mode refer to section "[5.10.2 Assembling the COM Connector](#)". NS Protection(including Passive Valid) can be set. When NS-1 and NS-2 are connected, the inverters will emergently stop; otherwise, the inverters will operate normally. But if NS Protection is enabled on the iSolarCloud, refer to "[NS Protection\(Passive Valid\)](#)", the inverters will operate normally when NS-1 and NS-2 are connected, and the inverters will emergently stop when NS-1 and NS-2 are disconnected.

The recommended wire conductor cross-section is 0.5 - 0.75 mm<sup>2</sup> , and the maximum wiring distance of NS protection loop must be less than 100 m.

Refer to section "[5.9.1 Assembling the COM Connector](#)" for detailed assembling procedure. Plug the wires to **NS-1** and **NS-2** terminals according the labels on the bottom of the inverter. When terminals **NS-1** and **NS-2** are turned on by the external NS protection relay, the inverter will stop immediately.

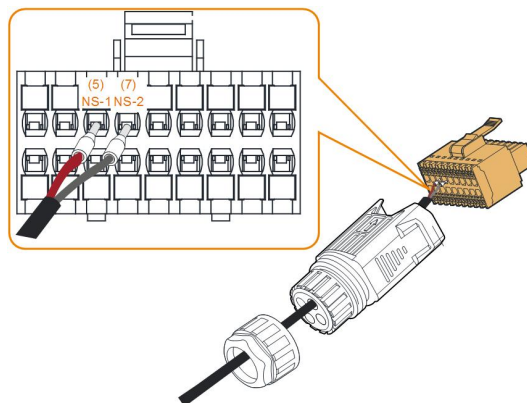

Refer to section "[5.10.3 Installing the COM Connector](#)" to install the connector.

# 6 Commissioning

## 6.1 Inspection before Commissioning

Check the following items before starting the inverter:

- All equipment has been reliably installed.
- DC switch(es) and AC circuit breaker are in the "OFF" position.
- The ground cable is properly and reliably connected.
- The AC cable is properly and reliably connected.
- The DC cable is properly and reliably connected.
- The communication cable is properly and reliably connected.
- The vacant terminals are sealed.
- No foreign items, such as tools, are left on the top of the machine or in the junction box (if there is).
- The AC circuit breaker is selected in accordance with the requirements of this manual and local standards.
- All warning signs & labels are intact and legible.

## 6.2 Powering on the System

If all of the items mentioned above meet the requirements, proceed as follows to start up the inverter for the first time.

- step 1 Turn on the AC circuit breaker between the inverter and the grid.
- step 2 Rotate the DC switch of the inverter to "ON" position.
- step 3 Turn on the external DC switch (if applicable) between the inverter and the PV string.
- step 4 If the irradiation and grid conditions meet requirements, the inverter will operate normally. Observe the LED indicator to ensure that the inverter operates normally. Refer to ["2.4 Indicator Definition"](#) for details.
- step 5 Refer to the quick guide for communication module for its indicator definition.
- step 6 Set initial protection parameters via the iSolarCloud App.
  - For WiFi module, please refer to ["7.2 Installing the App"](#), ["7.4.2 Login Procedure"](#) and ["7.5 Initial Settings"](#).
  - For WiNet-S module, please refer to sections 6.3 to 6.6.

-- End

## 6.3 App Preparation

- step 1 Install the iSolarCloud App with latest version. Refer to "7.2 Installing the App".
- step 2 Register an account. Refer to "7.3 Account Registration". If you have got the account and password from the distributor/installer or SUNGROW, skip this step.
- step 3 Download the firmware package to the mobile device in advance. Refer to "Firmware Update". This is to avoid download failure due to poor on-site network signal.

-- End

## 6.4 Creating a Plant

Screenshots of creating a plant are for reference only. For details, refer to the actual screen.

- step 1 Open the App, tap  at the upper right corner and tap **Select Server**. Choose the same server as when registering.

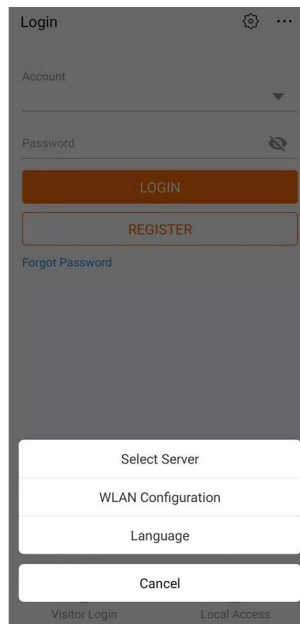



figure 6-1 Selecting the Server

- step 2 Enter the account and password on the login screen and tap **Login** to enter the App home screen.
- step 3 Tap the icon  at the upper right corner to enter the creating screen.

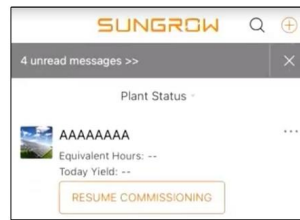

figure 6-2 Creating Power Plant

step 4 Select plant type to **RESIDENTIAL** and inverter type to **PV**.

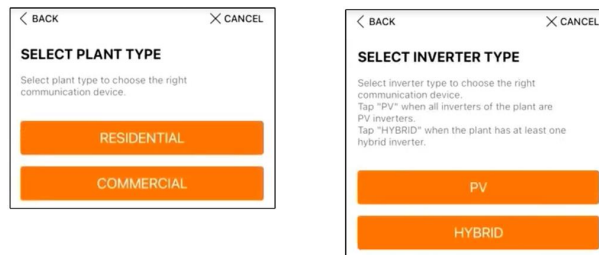

figure 6-3 Selecting Plant/Inverter Type

step 5 Scan the QR code on the communication device or manually enter the serial number of the communication device. Tap **Next** after the QR code is identified or the serial number entered is correct and then tap **CONFIRM**. Your mobile device is thus connected to the WiNet-S successfully.

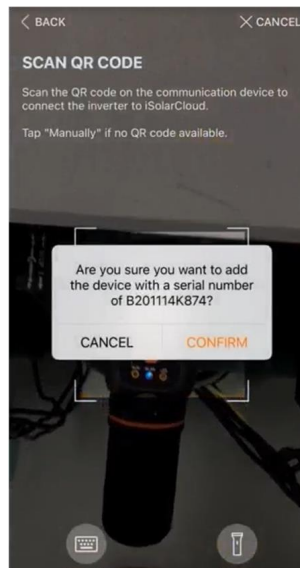

figure 6-4 Connecting Mobile Device to WiNet-S

step 6 Select the Internet access mode to **WLAN** or **ETHERNET** according to actual connection. The following description is for WLAN access mode.





**figure 6-5** Selecting Internet Access Mode

- step 7 The **EASYCONNECT INSTRUCTION** screen will prompt. Press the multi-function button on the WiNet-S module once to turn on EasyConnect mode. The WLAN indicator on WiNet-S blinks quickly when this mode is turned on. Return to the App and the screen displays successful connection to the inverter WLAN. Tap **NEXT**.

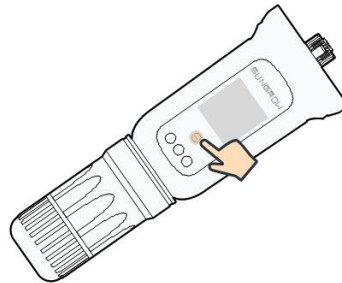
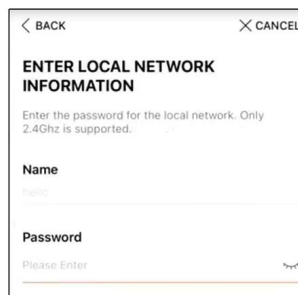

**figure 6-6** Turn on EasyConnect Mode

#### NOTICE

**The EasyConnect mode can be used only when the router is 2.4 GHz.  
If the EasyConnect mode fails, refer to the WiNet-S quick guide for the instructions of other modes.**

- step 8 Connect the inverter to router network. Enter network name and password. Tap **NEXT** and the screen display prompt information of successful connection to the router network.



**figure 6-7** Connecting Inverter to Router Network

-- End

## 6.5 Initializing the Device

The inverter is successfully connected to the router.

If there is no latest equipment upgrade package, skip steps 1 and 2.

The actual initializing procedure may differ due to different countries. Please follow the actual App guidance.

- step 1 If a latest equipment upgrade package is available, the following prompt window pops up. Tap **UPDATE NOW** to download the latest update package.

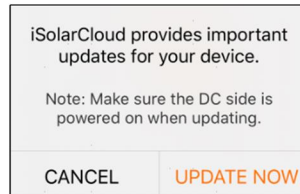

figure 6-8 Upgrade Reminder

- step 2 After download, it would take around 15 minutes to update. After successful upgrade, the screen will show the version numbers before and after the upgrade as well as the upgrade time. Tap **NEXT**.

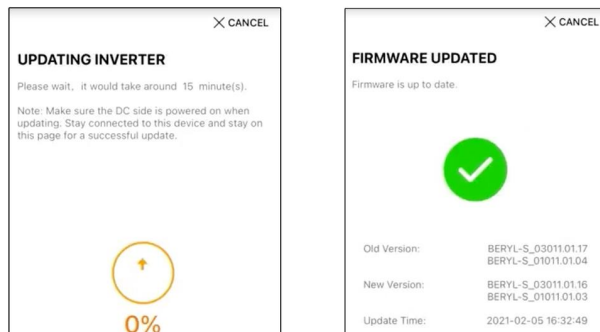

figure 6-9 Upgrading Inverter

### NOTICE

**If the communication equipment is upgraded, after successful upgrade, check and confirm that the phone is connected to the inverter WLAN.**

- step 3 Tap **Country/Region** and select the country where the inverter is installed at. The supported countries and corresponding settings are as follows.

Country/Region	Country Code Setting
Australia ("AU")	Australia
New Zealand ("NZ")	New Zealand
Poland ("PL")	Poland

Country/Region	Country Code Setting
Germany ("DE") / Cyprus / Luxembourg	Germany(Cyprus need proper manual settings)*
Brazil ("BR")	Brazil
Portugal / Hungary / Romania / Greece / Norway /Israel / Switzerland / Slovenia	EN50549-1, with proper manual settings*
Chile	Chile
Turkey	Turkey
France	France
Italy	Italy
Spain	Spain
Egypt	Egypt
Ireland	Ireland
Jordan	Jordan_G98
	Jordan_G99
Sweden	Sweden
Belgium	Belgium
Finland	Finland
Denmark	Thailand-MEA
	Thailand-PEA
Netherlands	Netherlands
Countries not listed above	"Other 50Hz" or "Other 60Hz"

\* Request guideline for manual settings from Sungrow.

#### NOTICE

**The parameter Country/Region must be set to the country (region) where the inverter is installed at. Otherwise, the inverter may report errors.**

step 4 When the country is set to Australia, additionally set the applicable network service provider and then the grid type.

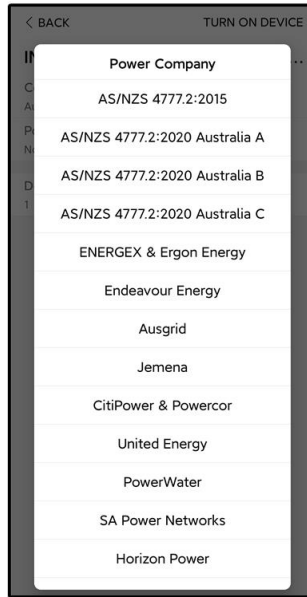

The image shown here is for reference only. Refer to the actual interface for the supported network service providers.

table 6-1 Description of Network Service Provider and Grid Type

Network Service Provider	Grid Type
AS/NZS 4777.2:2015	/
AS/NZS 4777.2:2020 Australia A	/
AS/NZS 4777.2:2020 Australia B	/
AS/NZS 4777.2:2020 Australia C	/
ENERGEX & Ergon Energy	<ul style="list-style-type: none"> <li>• STNW1170: single-phase &lt; 10 kVA &amp; three-phase &lt; 30 kVA</li> <li>• STNW1174: 30 kVA &lt; <math>P_n \leq 1500</math> kVA</li> </ul>
Jemena	<ul style="list-style-type: none"> <li>• <math>\leq 10</math> kVA per phase (or 30 kVA per three phase)</li> <li>• ELE GU 0014: 30 kVA–200 kVA</li> </ul>
Endeavour Energy	MDI 0043
Ausgrid	NS194
CitiPower & Powercor	<ul style="list-style-type: none"> <li>• <math>\leq 5</math> kVA for single-phase &amp; 30 kVA for three-phase</li> <li>• &gt; 30 kVA three-phase</li> </ul>

Network Service Provider	Grid Type
United Energy	<ul style="list-style-type: none"> <li>• UE-ST-2008.1: ≤ 10 kVA for single-phase &amp; 30 kVA for three-phase</li> <li>• UE-ST-2008.2: &gt; 30 kVA three-phase</li> </ul>
PowerWater	Embedded Generation Notice Photovoltaic Systems:2020
SA Power Networks	<ul style="list-style-type: none"> <li>• TS129-2019: &lt; 10 kW for single-phase &amp; 30 kW for three-phase</li> <li>• TS130-2017: &gt; 30 kW &amp; ≤ 200 kW</li> <li>• TS131-2018: &gt; 200 kW</li> </ul>
Horizon Power	<ul style="list-style-type: none"> <li>• HPC-9DJ-13-0001-2019: ≤ 10kVA for single-phase &amp; 30 kVA for three-phase</li> <li>• HPC-9DJ-13-0002-2019: &gt; 30kVA &amp; ≤1MVA</li> </ul>
westernpower	EDM # 33612889-2019
AusNet Services	Basic Micro Embedded Generation: 2020

\* For compliance with AS/NZS 4777.2:2020, please select from Australia A/B/C. Please contact your electricity grid operator for which region to use.

step 5 Initialize parameters according to local grid requirements, including grid type, reactive power regulation mode, etc. The screen displays that the inverter is successfully configured.

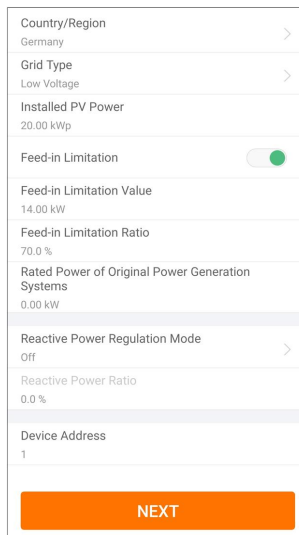

figure 6-10 Initializing Parameters

-- End

## 6.6 Configuring the Plant

The inverter is successfully added to the plant and initialized. Refer to the guidance in previous sections.

The distributor/installer who creates a plant for the end user needs to get the end user's e-mail address. In configuring a plant, the e-mail address is required, and each e-mail address can be registered only once.

step 1 The App screen will display the added inverter. Tap **NEXT** to configure the plant.

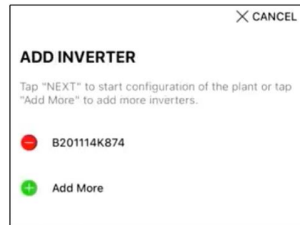

figure 6-11 Display the Added Inverter

step 2 Fill in the plant information. The fields marked with \* must be filled in.

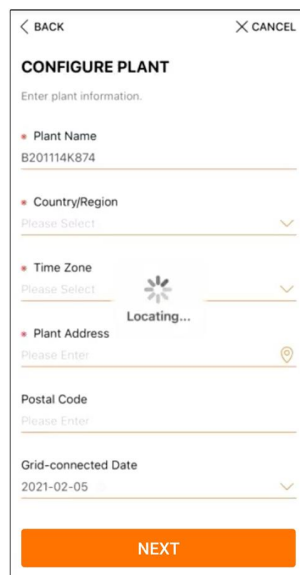

figure 6-12 Entering Plant Information

step 3 **(Optional)** Fill in the tariff information. The electricity price can be set to a specific value or Time-of-Use tariff.

**figure 6-13** Entering Tariff Information

- step 4 Fill in the end user's e-mail address. The first time you fill in the end user's e-mail address, the system will create an account for the end user and send an email to the end user. The end user can activate the account via the email.



The Distributor/installer creates plants for the end user and can manage the plants by default.

**figure 6-14** Entering Owner's e-mail

- step 5 Tap **NEXT** to wait for the inverter to connect to the iSolarCloud.

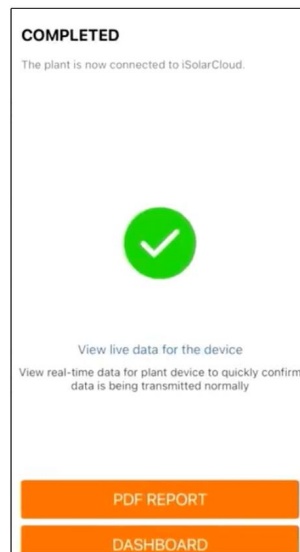

figure 6-15 Configuration Completed

step 6 (Optional) Tab **View live data for the device**, tick **Inverter** or **Total Plant Devices** and tab **ALL PLANTS OPEN**. The clock symbol indicates that the live data view function is successfully enabled. Tab the inverter to view the live data about voltage, current, power or curve.

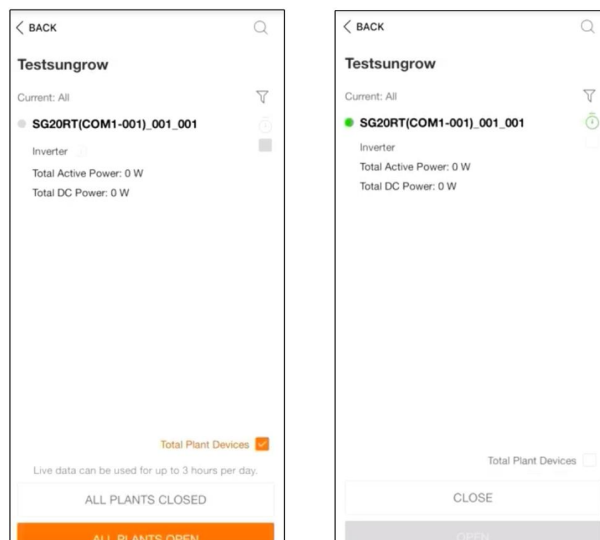

figure 6-16 Live Data View Function Setting



Contact Sungrow service to enable live data function of devices. Once enabled, live data function is available for 3 hours per day by default. To make it available for 24 hours, contact SUNGROW.

step 7 Tab **BACK** to the **COMPLETED** screen. Tab **PDF REPORT** to export the plant configuration report.



step 8 Tab **BACK** to the **COMPLETED** screen. Tab **DASHBOARD** to return and manually refresh the page until the newly created plant is displayed with status commissioned.

**-- End**

# 7 iSolarCloud App

## 7.1 Brief Introduction

The iSolarCloud App can establish communication connection to the inverter via the WLAN, providing remote monitoring, data logging and near-end maintenance on the inverter. Users can also view inverter information and set parameters through the App.

\* To achieve direct login via WLAN, the wireless communication module developed and manufactured by SUNGROW is required. The iSolarCloud App can also establish communication connection to the inverter via Ethernet connection.



- This manual describes only how to achieve near-end maintenance via WLAN direct connection.
- Screenshots in this manual are based on the V2.1.6 App for Android system, and the actual interfaces may differ.

## 7.2 Installing the App

### Method 1

Download and install the App through the following application stores:

- MyApp (Android, mainland China users)
- Google Play (Android, users other than mainland China ones)
- App Store (iOS)

### Method 2

Scan the following QR code to download and install the App according to the prompt information.



The App icon appears on the home screen after installation.



### 7.3 Account Registration

The account distinguishes two user groups, end user and distributor/installer.

- The end user can view plant information, create plants, set parameters, share plants, etc.
- The distributor/installer can help the end user to create plants, manage, install, or maintain plants, and manage users and organizations.

step 1 Tap **REGISTER** to enter the registration screen.

**USER REGISTRATION**

**Account Type**

BASE Plant

Please select the relevant server for your area; if not available, please select the international station

Distributor/Installer

Distributor/Installer is the person who install or/and manage the plant, and supply service to end user

End User

End User is the person who will own or has owned one inverter or more

step 2 Select the relevant server for your area.

step 3 Select **End user** or **Distributor/Installer** to enter the corresponding screen.

**DISTRIBUTOR/INSTALLER**

Email  @gmail.com ▾ \*

[Send Verification Code](#) ⓘ Help

Verification Code  \*

Password  \*

Confirm Password  \*

Country/Region  ▾ \*

Company Name

Code of Upper Level Installer/Distributor  ⓘ

[Accept Privacy Policy](#)

Register

step 4 Fill in the registration information, including email, verification code, password and affirmation and country (region). The distributor/installer has the permission to fill in the company name and the code of upper level distributor/installer.



The code of upper level distributor/installer can be obtained from the upper level distributor/installer. Only when your organization belongs to the upper level distributor/installer organization, can you fill in the corresponding code.

step 5 Tick **Accept privacy protocol** and tap **Register** to finish the registration operation.

-- End

## 7.4 Login

### 7.4.1 Requirements

The following requirements should be met:

- The AC and DC sides or the AC side of the inverter is powered-on.
- The WLAN function of the mobile phone is enabled.
- The mobile phone is within the coverage of the wireless network produced by the communication module.

### 7.4.2 Login Procedure

step 1 For the WiNet-S module, press the multi-function button 3 times to enable the WLAN hot-spot. No password is required and the valid time is 30 minutes.

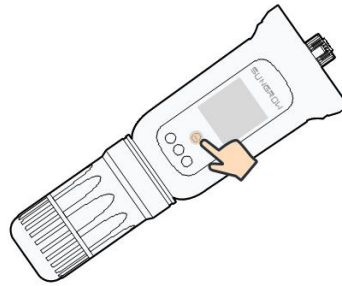

figure 7-1 Enabling the WLAN Hotspot

- step 2 Connect the mobile phone to the WLAN network named as "SG-xxxxxxxxxx" (xxxxxxxxxx is the serial number indicated on the side of the communication module).
- step 3 Open the App to enter the login screen. Tap **Local Access** to enter the next screen.
- step 4 Select **WLAN** and select the device (SN), then enter the password and tap **LOGIN**.



- If the WiFi signal, serial number or inverter related data information cannot be found, unplug and reinsert the Winet-S or press the multi-function button of the Winet-S three times.
- The default account is "user" and the initial password is "pw1111" which should be changed for the consideration of account security. Tap "More" at the lower right corner on home page and choose "Change Password".

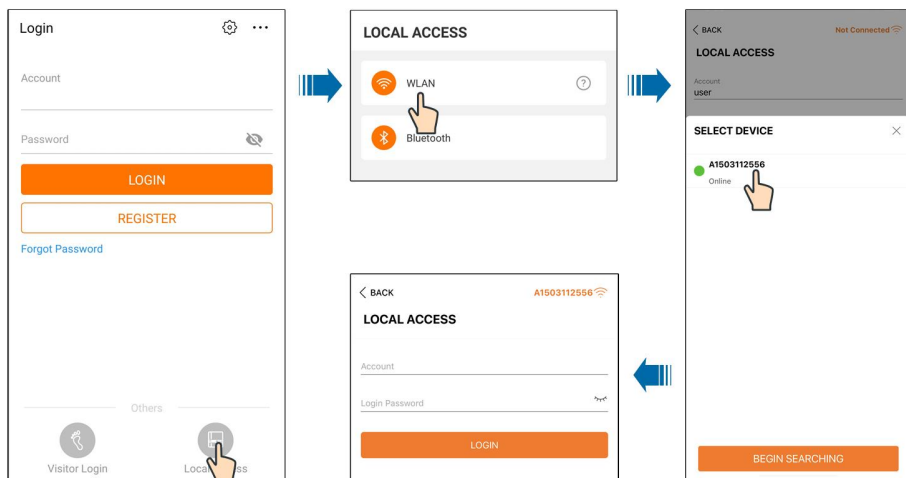
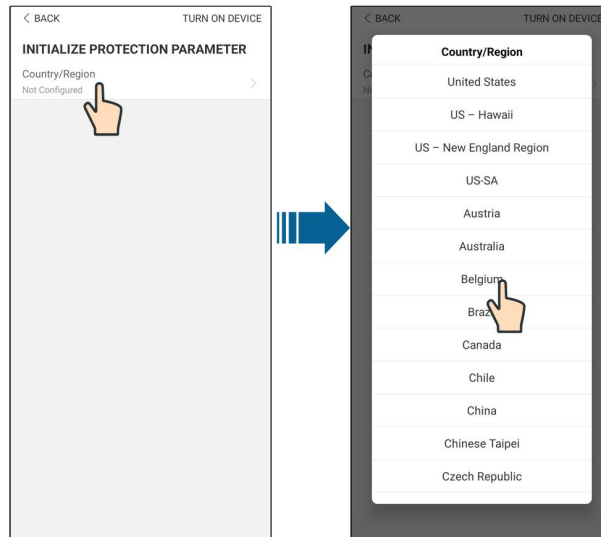

figure 7-2 WLAN Local Access

- step 5 If the inverter is not initialized, navigate to the quick setting screen to initialize the protection parameters. For details, please refer to "**Initial Settings**".

**NOTICE**

**The "Country/Region" must be set to the country where the inverter is installed at. Otherwise, the inverter may report errors.**



**figure 7-3** WLAN Local Access

- step 6 After finishing the settings, tap **TUNR ON DEVICE** at the upper right corner and the device will be initialized. The App will send start instructions and the device will start and operate.
- step 7 After initialization settings, the App will return automatically to the home page.

-- End

## 7.5 Initial Settings

Tap **Country/Region** and select the country where the inverter is installed. For countries except Australia and Germany, the initialization is completed.



The actual initializing procedure may differ due to different countries. Please follow the actual App guidance.

For some countries, you should initialize parameters according to local grid requirements. For details, see "[6.5 Initializing the Device](#)".

## 7.6 Function Overview

The App provides parameter viewing and setting functions, as shown in the following figure.

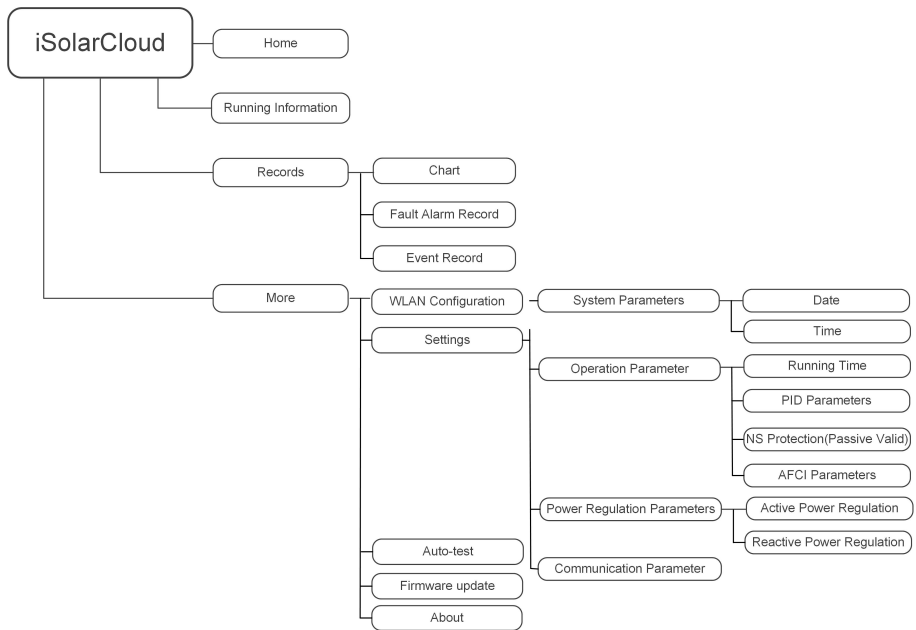

**figure 7-4** App Key Function Menu

## 7.7 Home

Home page of the App is shown in the following figure.



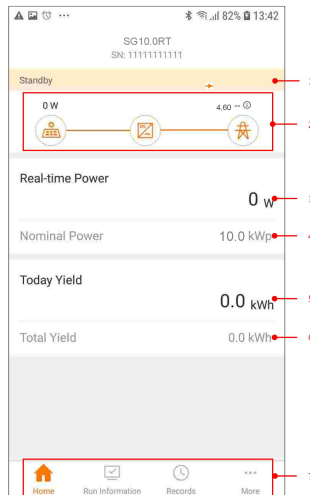



figure 7-5 Home

table 7-1 Home Page Description

No.	Name	Description
1	Inverter state	Present operation state of the inverter
2	Energy flow chart	Shows the PV power generation power, feed-in power, etc. The line with an arrow indicates energy flow between connected devices, and the arrow pointing indicates energy flow direction.
3	Real-time power	Shows the present output power of the inverter.
4	Nominal power	Shows the installed power of the inverter.
5	Today yield	Shows today power generation of the inverter
6	Total yield	Shows accumulative power generation of the inverter
7	Navigation bar	Includes menus of "Home", "Run Information", "Records" and "More".

If the inverter runs abnormally, the fault icon  will appear on the upper left corner of the screen. Users can tap the icon to view detailed fault information and corrective measures.

## 7.8 Run Information

Tap **Run Information** on the navigation bar to enter the screen showing running information, slide the screen upwards to view all detailed information.

table 7-2 Description of Run Information

Item	Description
PV information	Shows voltage and current of every PV string.
Inverter information	Shows basic information such as running state, on-grid running time, negative voltage to grid, bus voltage, internal air temperature, inverter efficiency, etc.
Input	Shows total DC power, voltage and current of MPPT1 and MPPT2.
Output	Shows daily/monthly/annual/total yield, total active/reactive/apparent power, total power factor, grid frequency, phase voltage and current.
Grid information	Shows daily/total feed-in energy, daily/total purchased energy.

## 7.9 Records

Tap **Records** on the navigation bar to enter the screen showing event records, as shown in the following figure.

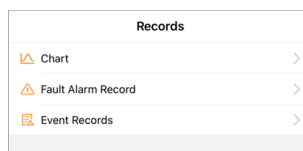

figure 7-6 Records

### Chart

Tap **Chart** to enter the screen showing daily power generation, as shown in the following figure.



**figure 7-7** Chart

The App displays power generation records in a variety of forms, including daily power generation graph, monthly power generation histogram, annual power generation histogram and total power generation histogram.

table 7-3 Description of Power Curve

Item	Description
Daily	Daily curve that indicates the real-time power.
Month	Monthly curve that indicates daily yield and equivalent hours in a month.
Year	Annual curve that indicates monthly yield and equivalent hours in a year.
Total	A curve that indicates annual yield and equivalent hours since installation.

### Fault Alarm Record

Tap **Fault Alarm Record** to enter the screen, as shown in the following figure.

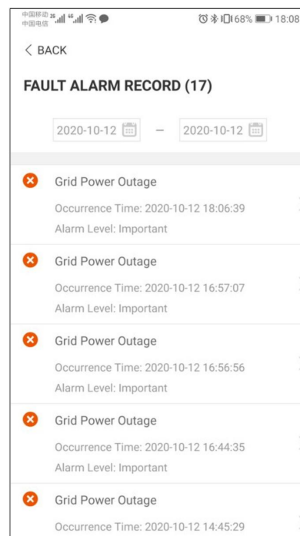



figure 7-8 Fault Alarm Record



Click  to select a time segment and view corresponding records.

Select one of the records in the list and click the record, to view the detailed fault info as shown in following figure.



figure 7-9 Detailed Fault Alarm Information

## Event Record

Tap **Event Record** to enter the screen, as shown in the following figure.

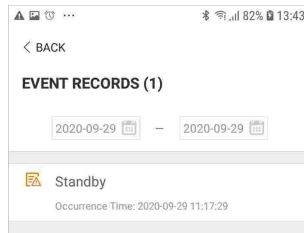



figure 7-10 Event Record



Click  to select a time segment and view corresponding records.

## 7.10 More

Tap **More** on the navigation bar to enter the corresponding screen, as shown in the following figure.

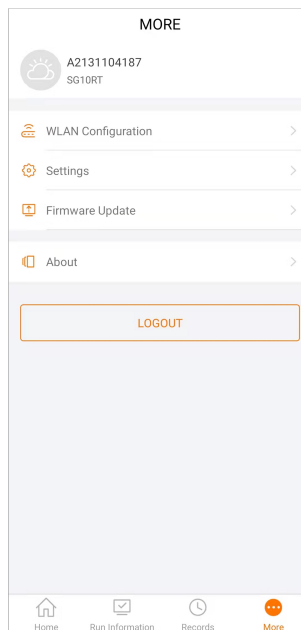

figure 7-11 More

In addition to viewing the WLAN configuration and App software version, the **More** screen supports the following operations:

- Set parameters including inverter system parameters, operation parameters, power regulation parameters and communication parameters.
- Upgrade inverter firmware.

### 7.10.1 System Parameters

Tap **Settings**→**System Parameters** to enter the corresponding screen, as shown in the following figure.

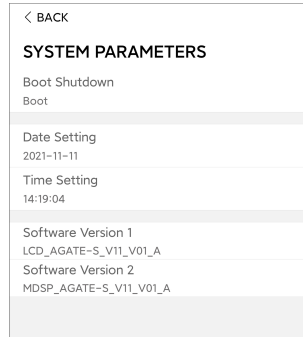

figure 7-12 System Parameters

#### Boot/Shutdown

Tap **Boot/Shutdown** to send the boot/shutdown instruction to the inverter.

For Australia and New Zealand, when the DRM state is DRM0, the "Boot" option will be prohibited.

#### Date Setting/Time Setting

The correct system time is very important. Wrong system time will directly affect the data logging and power generation value. The clock is in 24-hour format.

#### Software Version

Version information of the current firmware.

### 7.10.2 Operation Parameters

#### Running Time

Tap **Settings**→**Operation Parameters**→**Running Time** to enter the corresponding screen, on which you can set the "Connecting Time" and "Reconnecting Time".

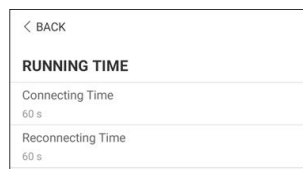

figure 7-13 Running Time

#### PID Parameters

Tap **Settings**→**Operation Parameters**→**PID Parameters** to enter the corresponding screen, on which you can set "PID Parameters".

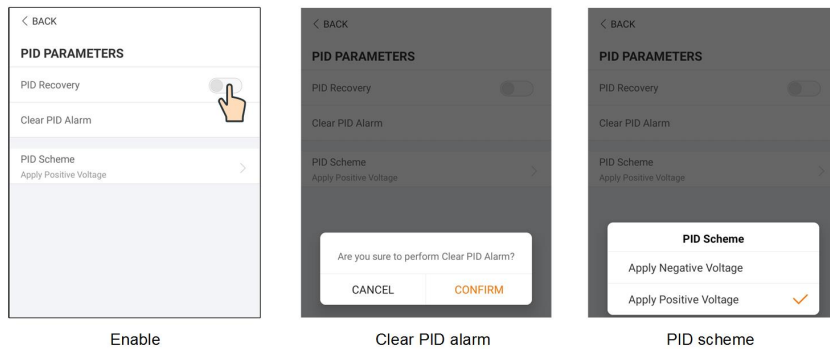

figure 7-14 PID Setting

table 7-4 PID Parameter Description

Parameter	Description
<b>PID Recovery</b>	Set enabling/disabling of the PID night recovery function. PID night recovery functions between 22:00 pm and 5:00 am by default.
<b>Clear PID alarm</b>	If ISO impedance abnormality or PID function exception is detected during running of the PID function, the inverter reports a PID false alarm and reminds the user to take corresponding measures. After processing, clear the alarm via this parameter.
<b>PID Scheme</b>	Apply negative or positive voltage.



- For the selection of negative or positive voltage, please consult the supplier of PV panels.
- After the PID night recovery function is enabled, the fault indicator on the inverter front panel turns green.

**NS Protection(Passive Valid)**

Tap **Settings**→**Operation Parameters**→**Regular Parameters** to enter the corresponding screen, on which you can set the "NS Protection(Passive Valid)". When the NS Protection (Passive Valid) button is set to green, the Passive Valid mode is turned on. When the NS Protection(Passive Valid) button is set to gray, the Active Valid mode is turned on.

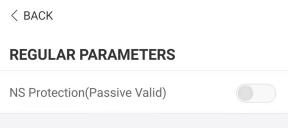

figure 7-15 NS Protection(Passive Valid)

**AFCI Parameters(Optional)**

Tap **Settings**→**Operation Parameters**→**AFCI Parameters** to enter the corresponding screen, on which you can set "AFCI Parameters".

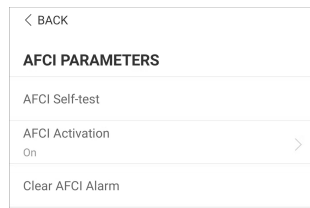

figure 7-16 AFCI Setting

### 7.10.3 Power Regulation Parameters

#### Active Power Regulation

Tap **Settings**→**Power Regulation Parameters**→**Active Power Regulation** to enter the screen, as shown in the following figure.

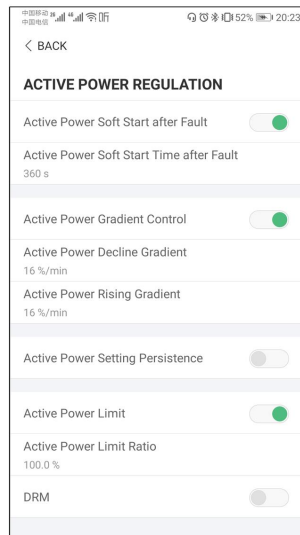

figure 7-17 Active Power Regulation

table 7-5 Description of Active Power Regulation Parameters

Parameter	Description	Range
<b>Active Power Soft Start after Fault</b>	Switch for activating/deactivating the function of active power soft start after a fault occurs	On/Off
<b>Active Power Soft Start Time after Fault</b>	The soft start time required for raising active power from 0 to rated value after a fault occurs	1 s–1200 s
<b>Active Power Gradient Control</b>	Set whether to enable active power gradient control	On/Off
<b>Active Power Decline Gradient</b>	Decline gradient of inverter active power per minute	1%/min–
<b>Active Power Rising Gradient</b>	Rising gradient of inverter active power per minute	6000 %/min



Parameter	Description	Range
<b>Active Power Setting Persistence</b>	Switch for activating/deactivating the function of active power setting persistence	On/Off
<b>Active Power Limit</b>	Switch for limiting active power	On/Off
<b>Active Power Limit Ratio</b>	The ratio of active power limit to rated power in percentage	0.0 %–110.0 %
<b>DRM</b>	Switch for activating/deactivating the DRM function	On/Off

### Reactive Power Regulation

Tap **Settings**→**Power Regulation Parameters**→**Reactive Power Regulation** to enter the screen, as shown in the following figure.



figure 7-18 Reactive Power Regulation

table 7-6 Description of Reactive Power Regulation Parameters

Parameter	Description	Range
<b>Reactive Power Setting Persistence</b>	Switch for activating/deactivating the function of reactive power setting persistence	On/Off
<b>Reactive Power Regulation Mode</b>	Off/PF/Qt/Q(P)/Q(U)	Off/PF/Qt/Q(P)/Q(U)
<b>Reactive Response</b>	Switch for activating/deactivating the function of reactive response	On/Off
<b>Reactive Response Time</b>	Time for reactive response	0.1 s-600 s

#### "Off" Mode

The reactive power regulation function is disabled. The PF is fixed at +1.000.

#### "PF" Mode

The power factor (PF) is fixed and the reactive power is regulated by the parameter PF. The PF ranges from 0.8 leading to 0.8 lagging.

- Leading: the inverter is sourcing reactive power to the grid.
- Lagging: the inverter is injecting reactive power into the grid.

**"Qt" Mode**

In the Qt mode, the reactive power can be regulated by the parameter Q-Var limits (in %). The system rated reactive power is fixed, the system injects reactive power according to the delivered reactive power ratio. The "Reactive Power Ratio" is set through the App.

The setting range of the reactive power ratio is from -100 % to 100 %, corresponding to the ranges of inductive and capacitive reactive power regulation respectively.

**"Q(P)" Mode**

The PF of the inverter output varies in response to the output power of the inverter.

table 7-7 "Q(P)" Mode Parameters Explanation

Parameter	Explanation	Range
Q(P) Curve	Select corresponding curve according to local regulations	A, B, C*
QP_P1	Output power at point P1 on the Q(P) mode curve (in %)	20.0 %–100.0 %
QP_P2	Output power at point P2 on the Q(P) mode curve (in %)	20.0 %–100.0 %
QP_P3	Output power at point P3 on the Q(P) mode curve (in %)	20.0 %–100.0 %
QP_K1	Power factor at point P1 on the Q(P) mode curve	Curve A/C: 0.800 to 1.000 Curve B: -0.600 to 0.600
QP_K2	Power factor at point P2 on the Q(P) mode curve	
QP_K3	Power factor at point P3 on the Q(P) mode curve	
QP_EnterVoltage	Voltage for Q(P) function activation (in %)	100.0 %–110.0 %
QP_ExitVoltage	Voltage for Q(P) function deactivation (in %)	90.0 %–100.0 %
QP_ExitPower	Power for Q(P) function deactivation (in %)	1.0 %–20.0 %
QP_EnableMode	Unconditional activation/deactivation of Q(P) function	Yes, No

\* Curve C is reserved and consistent with Curve A currently.

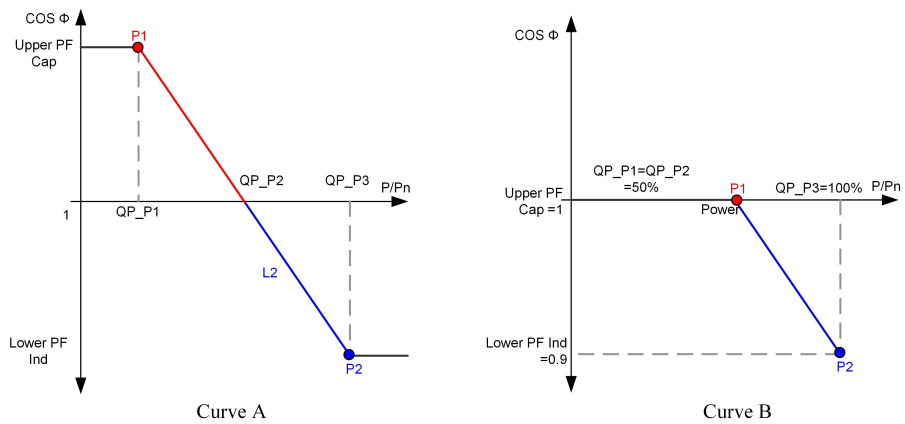

figure 7-19 Reactive Power Regulation Curve in Q(P) Mode

### "Q(U)" Mode

The reactive power output of the inverter varies in response to the grid voltage.

table 7-8 "Q(U)" Mode Parameter Explanation

Parameter	Explanation	Range
Q(U) curve	Select corresponding curve according to local regulations	A, B, C*
Hysteresis Ratio	Voltage hysteresis ratio on the Q(U) mode curve	0.0 %–5.0 %
QU_V1	Grid voltage limit at point P1 on the Q(U) mode curve (in %)	80.0 %–100.0 %
QU_V2	Grid voltage limit at point P2 on the Q(U) mode curve (in %)	80.0 %–100.0 %
QU_V3	Grid voltage limit at point P3 on the Q(U) mode curve (in %)	100.0 %–120.0 %
QU_V4	Grid voltage limit at point P4 on the Q(U) mode curve (in %)	100.0 %–120.0 %
QU_Q1	Value of Q/Sn at point P1 on the Q(U) mode curve (in %)	-60.0 % to 0.0 %
QU_Q2	Value of Q/Sn at point P2 on the Q(U) mode curve (in %)	-60.0 % to 60.0 %
QU_Q3	Value of Q/Sn at point P3 on the Q(U) mode curve (in %)	-60.0 % to 60 %

Parameter	Explanation	Range
QU_Q4	Value of Q/Sn at point P4 on the Q(U) mode curve (in %)	0.0 % to 60.0 %
QU_EnterPower	Active power for Q(U) function activation (in %)	20.0 %–100.0 %
QU_ExitPower	Active power for Q(U) function deactivation (in %)	1.0 %–20.0 %
QU_EnableMode	Unconditional activation/deactivation of Q(U) function	Yes, No, Yes (Limited by PF)
QU_Limited PF Value	Preset PF value	0–0.95

\* Curve C is reserved and consistent with Curve A currently.

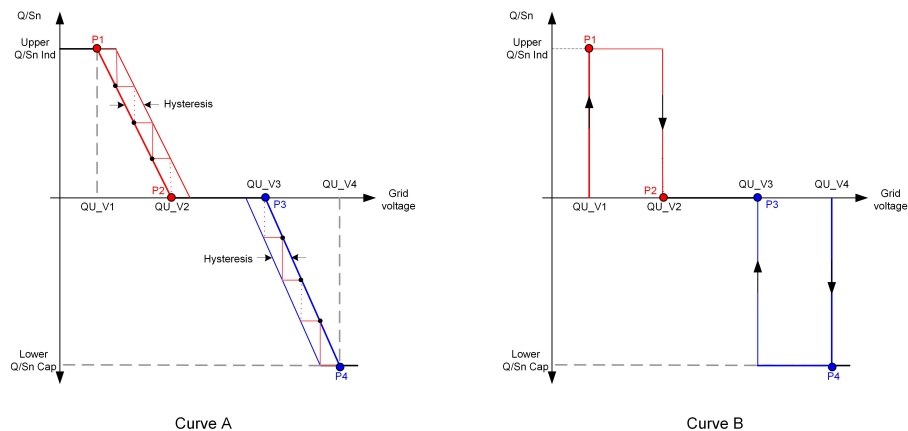

figure 7-20 Reactive Power Regulation Curve in Q(U) Curve

#### 7.10.4 Communication Parameters

Tap **Settings**→**Communication Parameters**→**Serial Port Parameters** to enter the corresponding interface, as shown in the following figure.

**SERIAL PORT PARAMETERS**

Device Address

1

figure 7-21 Serial Port Parameters

table 7-9 Serial Port Parameters

Parameter	Range
Device Address	1–246

### MPLC Parameters

Tap **Settings**→**Communication Parameters**→**MPLC Parameters** to enter the corresponding interface, as shown in the following figure.

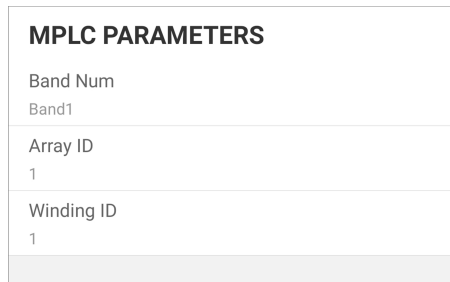

**MPLC PARAMETERS**

Band Num  
Band1

Array ID  
1

Winding ID  
1

figure 7-22 MPLC Parameters

table 7-10 MPLC Parameters

Parameter	Range
Band Num	Band1, Band2
Array ID	1–255
Winding ID	1–10

### 7.10.5 Firmware Update

To avoid download failure due to poor on-site network signal, it is recommended to download the firmware package to the mobile device in advance.

- step 1 Enable the "Mobile data" of the mobile device.
- step 2 Open the App, enter the account and password on the login screen. Tap **Login** to enter the home screen.
- step 3 Tap **More**→**Firmware Download** to enter corresponding screen on which you can view the device list.
- step 4 Select the device model before downloading the firmware. Tap the device name in the device list to enter the firmware upgrade package detail interface, and tap  behind the firmware upgrade package to download it.

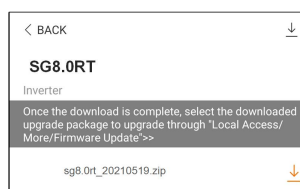

- step 5 Return to the **Firmware Download** screen, tap  in the upper right corner of the screen to view the downloaded firmware upgrade package.
- step 6 Login the App via local access mode. Refer to "7.4 Login".

step 7 Tap **More** on the App home screen and then tap **Firmware Update**.

step 8 Tap the upgrade package file, a prompt box will pop up asking you to upgrade the firmware with the file, tap **CONFIRM** to perform the firmware upgrade.

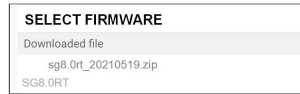

step 9 Wait for the file to be uploaded. When the upgrade is finished, the interface will inform you of the upgrade completion. Tap **Complete** to end the upgrade.

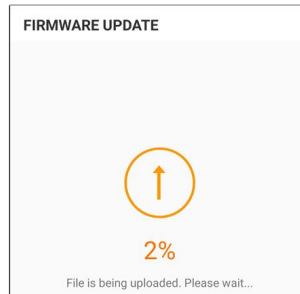

-- End

### 7.10.6 Auto-test

Tap **Auto-test** to enter the corresponding screen, as shown in the following figure.

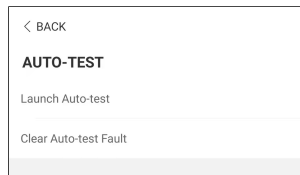

figure 7-23 Auto-test

#### Launch Auto-test

Tap **Launch Auto-test** carry out an auto-test. Auto-testing will take about 5 minutes. When the auto-test is completed, the auto-test report is displayed, as shown in the figure below. Tap **DOWNLOAD** to download the report.

AUTO-TEST RESULT	
Auto-test Result	Successful
Over-frequency Level 1 (81>.S1) Successful	
Frequency Threshold	51.50 Hz
Frequency Sample Value	50.00 Hz
Time Threshold	0.10 s
Time Sample Value	0.10 s
Under Frequency Level 1 (81<.S1) Successful	
Frequency Threshold	47.50 Hz
Frequency Sample Value	49.99 Hz
Time Threshold	0.10 s
Time Sample Value	0.10 s
Over-voltage Level 1 (59.S1) Successful	
<b>DOWNLOAD</b>	

figure 7-24 Auto-test Result

### Clear Auto-test Fault

Tap **Clear Auto-test Fault**→**CONFIRM** to clear the auto-test fault.

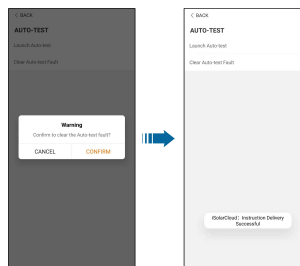

figure 7-25 Clear Auto-test Fault

### 7.10.7 SPI(Only for Italy)



Contact SUNGROW to obtain the advanced account and corresponding password before setting the SPI parameters.

Unauthorized personnel are not allowed to log in with this account. Otherwise, SUNGROW shall not be held liable for any damages caused.

Tap **More**→**Settings**→**Protection Parameters**→**Other Parameters** to enter the corresponding screen, on which you can modify the value of "External Signal for Italian Grid" and "SPI Local Signal for Italian Grid", and confirm the settings by enabling "Grid Protection Value Auto Adjustment".

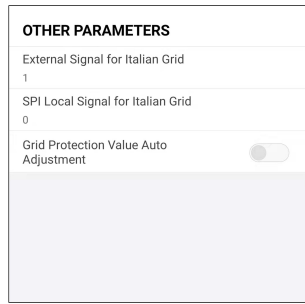

**figure 7-26** SPI



## 8 System Decommissioning

### 8.1 Disconnecting the Inverter

#### CAUTION

**Risk of burns due to hot components!**

**Even if the inverter is shut down, it may still be hot and cause burns. Wear protective gloves before operating the inverter after it cools down.**

For maintenance or other service work, the inverter must be switched off.

Proceed as follows to disconnect the inverter from the AC and DC power sources. Lethal voltages or damage to the inverter will follow if otherwise.

- step 1 Disconnect the external AC circuit breaker and secure it against reconnection.
- step 2 Rotate the DC switch to the "OFF" position for disconnecting all of the PV string inputs.
- step 3 Wait about 10 minutes until the capacitors inside the inverter completely discharge.
- step 4 Ensure that the DC cable is current-free via a current clamp.

-- End

### 8.2 Dismantling the Inverter

#### CAUTION

**Risk of burn injuries and electric shock!**

**Do not touch any inner live parts until for at least 10 minutes after disconnecting the inverter from the utility grid and the PV input.**



Before dismantling the inverter, disconnect both AC and DC connections.

If there are more than two layers of inverter DC terminals, dismantle the outer DC connectors before dismantling the inner ones.

- step 1 Refer to "[5 Electrical Connection](#)", for the inverter disconnection of all cables in reverse steps. In particular, when removing the DC connector, use an MC4 wrench to loosen the locking parts and install waterproof plugs.

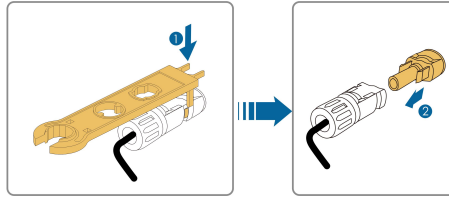

step 2 Refer to "[4 Mechanical Mounting](#)", to dismantle the inverter in reverse steps.

step 3 If necessary, remove the wall-mounting bracket from the wall.

step 4 If the inverter will be used again in the future, please refer to "[3.2 Inverter Storage](#)" for a proper conservation.

-- End

### 8.3 Disposal of the Inverter

Users take the responsibility for the disposal of the inverter.

#### NOTICE

**Some parts and devices of the inverter, such as the capacitors, may cause environmental pollution.**

**Do not dispose of the product together with household waste but in accordance with the disposal regulations for electronic waste applicable at the installation site.**

## 9 Troubleshooting and Maintenance

### 9.1 Troubleshooting

Once the inverter fails, the fault information can be displayed on the App interface. If the inverter is equipped with an LCD screen, the fault information can be viewed on it.

The fault codes and troubleshooting methods of all PV inverters are detailed in the table below. The device you purchase may only contain some of the fault information, and when the inverter fails, you can check the corresponding information through the fault codes from the mobile app.

Fault code	Fault name	Corrective measures
2, 3, 14, 15	Grid Overvoltage	<p>Generally, the inverter will be reconnected to the grid after the grid returns to normal. If the fault occurs repeatedly:</p> <ol style="list-style-type: none"> <li>1. Measure the actual grid voltage, and contact the local electric power company for solutions if the grid voltage is higher than the set value.</li> <li>2. Check whether the protection parameters are appropriately set via the App or the LCD. Modify the overvoltage protection values with the consent of the local electric power operator.</li> <li>3. Contact Sungrow Customer Service if the preceding causes are ruled out and the fault persists.</li> </ol>
4, 5	Grid Undervoltage	<p>Generally, the inverter will be reconnected to the grid after the grid returns to normal. If the fault occurs repeatedly:</p> <ol style="list-style-type: none"> <li>1. Measure the actual grid voltage, and contact the local electric power company for solutions if the grid voltage is lower than the set value.</li> <li>2. Check whether the protection parameters are appropriately set via the App or the LCD.</li> <li>3. Check whether the AC cable is firmly in place.</li> <li>4. Contact Sungrow Customer Service if the preceding causes are ruled out and the fault persists.</li> </ol>

Fault code	Fault name	Corrective measures
8	Grid Overfrequency	<p>Generally, the inverter will be reconnected to the grid after the grid returns to normal. If the fault occurs repeatedly:</p> <ol style="list-style-type: none"> <li>1. Measure the actual grid frequency, and contact the local electric power company for solutions if the grid frequency is beyond the set range.</li> </ol>
9	Grid Underfrequency	<ol style="list-style-type: none"> <li>2. Check whether the protection parameters are appropriately set via the App or the LCD.</li> <li>3. Contact Sungrow Customer Service if the preceding causes are ruled out and the fault persists.</li> </ol>
10	Grid Power Outage	<p>Generally, the inverter will be reconnected to the grid after the grid returns to normal. If the fault occurs repeatedly:</p> <ol style="list-style-type: none"> <li>1. Check whether the grid supplies power reliably.</li> <li>2. Check whether the AC cable is firmly in place.</li> <li>3. Check whether the AC cable is connected to the correct terminal (whether the live wire and the N wire are correctly in place).</li> <li>4. Check whether the AC circuit breaker is connected.</li> <li>5. Contact Sungrow Customer Service if the preceding causes are ruled out and the fault persists.</li> </ol>
12	Excess Leakage Current	<ol style="list-style-type: none"> <li>1. The fault can be caused by poor sunlight or damp environment, and generally the inverter will be reconnected to the grid after the environment is improved.</li> <li>2. If the environment is normal, check whether the AC and DC cables are well insulated.</li> <li>3. Contact Sungrow Customer Service if the preceding causes are ruled out and the fault persists.</li> </ol>

Fault code	Fault name	Corrective measures
13	Grid Abnormal	<p>Generally, the inverter will be reconnected to the grid after the grid returns to normal. If the fault occurs repeatedly:</p> <ol style="list-style-type: none"> <li>1. Measure the actual grid, and contact the local electric power company for solutions if the grid parameter exceeds the set range.</li> <li>2. Contact Sungrow Customer Service if the preceding causes are ruled out and the fault persists.</li> </ol>
17	Grid Voltage Imbalance	<p>Generally, the inverter will be reconnected to the grid after the grid returns to normal. If the fault occurs repeatedly:</p> <ol style="list-style-type: none"> <li>1. Measure the actual grid voltage. If grid phase voltages differ greatly, contact the electric power company for solutions.</li> <li>2. If the voltage difference between phases is within the permissible range of the local power company, modify the grid voltage imbalance parameter through the App or the LCD.</li> <li>3. Contact Sungrow Customer Service if the preceding causes are ruled out and the fault persists.</li> </ol>
28, 29, 208, 448-479	PV Reserve Connection Fault	<ol style="list-style-type: none"> <li>1. Check whether the corresponding string is of reverse polarity. If so, disconnect the DC switch and adjust the polarity when the string current drops below 0.5 A.</li> <li>2. Contact Sungrow Customer Service if the preceding causes are ruled out and the fault persists.</li> </ol> <p>*The code 28 to code 29 are corresponding to PV1 to PV2 respectively.</p> <p>*The code 448 to code 479 are corresponding to string 1 to string 32 respectively.</p>

Fault code	Fault name	Corrective measures
532-547, 564-579	PV Reverse Connection Alarm	<p>1. Check whether the corresponding string is of reverse polarity. If so, disconnect the DC switch and adjust the polarity when the string current drops below 0.5 A.</p> <p>2. Contact Sungrow Customer Service if the preceding causes are ruled out and the alarm persists.</p> <p>*The code 532 to code 547 are corresponding to string 1 to string 16 respectively.</p> <p>*The code 564 to code 579 are corresponding to string 17 to string 32 respectively.</p>
548-563, 580-595	PV Abnormal Alarm	<p>Check whether the voltage and current of the inverter is abnormal to determine the cause of the alarm.</p> <p>1. Check whether the corresponding module is sheltered. If so, remove the shelter and ensure module cleanness.</p> <p>2. Check whether the battery board wiring is loose, if so, make it reliably connected.</p> <p>3. Check if the DC fuse is damaged. If so, replace the fuse.</p> <p>4. Contact Sungrow Customer Service if the preceding causes are ruled out and the alarm persists.</p> <p>*The code 548 to code 563 are corresponding to string 1 to string 16 respectively.</p> <p>*The code 580 to code 595 are corresponding to string 17 to string 32 respectively.</p>

Fault code	Fault name	Corrective measures
37	Excessively High Ambient Temperature	<p>Generally, the inverter will resume operation when the internal or module temperature returns to normal. If the fault persists:</p> <ol style="list-style-type: none"> <li>1. Check whether the ambient temperature of the inverter is too high;</li> <li>2. Check whether the inverter is in a well-ventilated place;</li> <li>3. Check whether the inverter is exposed to direct sunlight. Shield it if so;</li> <li>4. Check whether the fan is running properly. Replace the fan if not;</li> <li>5. Contact Sungrow Power Customer Service if the fault is due to other causes and the fault persists.</li> </ol>
43	Excessively Low Ambient Temperature	<p>Stop and disconnect the inverter. Restart the inverter when the ambient temperature rises within the operation temperature range.</p>
39	Low System Insulation Resistance	<p>Wait for the inverter to return to normal. If the fault occurs repeatedly:</p> <ol style="list-style-type: none"> <li>1. Check whether the ISO resistance protection value is excessively high via the app or the LCD, and ensure that it complies with the local regulations.</li> <li>2. Check the resistance to ground of the string and DC cable. Take corrective measures in case of short circuit or damaged insulation layer.</li> <li>3. If the cable is normal and the fault occurs on rainy days, check it again when the weather turns fine.</li> <li>4. Contact Sungrow Customer Service if the preceding causes are ruled out and the fault persists.</li> </ol>



Fault code	Fault name	Corrective measures
106	Grounding Cable Fault	<ol style="list-style-type: none"> <li>1. Check whether the AC cable is correctly connected.</li> <li>2. Check whether the insulation between the ground cable and the live wire is normal.</li> <li>3. Contact Sungrow Customer Service if the preceding causes are ruled out and the fault persists.</li> </ol>
88	Electric Arc Fault	<ol style="list-style-type: none"> <li>1. Disconnect the DC power supply, and check whether any DC cable is damaged, the connection terminal or fuse is loose or there is a weak contact. If so, replace the damaged cable, fasten the terminal or fuse, and replace the burnt component.</li> <li>2. After performing step 1, reconnect the DC power supply, and clear the electric arc fault via the App or the LCD, after that the inverter will return to normal.</li> <li>3. Contact Sungrow Customer Service if the fault persists.</li> </ol>
84	Reverse Connection Alarm of the Meter/CT	<ol style="list-style-type: none"> <li>1. Check if the meter is wrongly connected.</li> <li>2. Check if the input and output wiring of the meter is reversed.</li> <li>3. If the existing system is enabled, please check if the rated power setting of the existing inverter is correct.</li> </ol>
514	Meter Communication Abnormal Alarm	<ol style="list-style-type: none"> <li>1. Check whether the communication cable and the terminals are abnormal. If so, correct them to ensure reliable connection.</li> <li>2. Reconnect the communication cable of the meter.</li> <li>3. Contact Sungrow Customer Service if the preceding causes are ruled out and the alarm persists.</li> </ol>
323	Grid Confrontation	<ol style="list-style-type: none"> <li>1. Check whether the output port is connected to actual grid. Disconnect it from the grid if so.</li> <li>2. Contact Sungrow Customer Service if the preceding causes are ruled out and the fault persists.</li> </ol>

Fault code	Fault name	Corrective measures
75	Inverter Parallel Communication Alarm	<ol style="list-style-type: none"> <li>1. Check whether the communication cable and the terminals are abnormal. If so, correct them to ensure reliable connection.</li> <li>2. Reconnect the communication cable of the meter.</li> <li>3. Contact Sungrow Customer Service if the preceding causes are ruled out and the alarm persists.</li> </ol>
<p>7, 11, 16, 19–25, 30– 34, 36, 38, 40–42, 44– 50, 52–58, 60–68, 85, 87, 92, 93, 100–105, 107–114, 116–124, 200–211, 248–255, 300–322, 324–327, 401–412, 600–603, 605, 608, 612, 616, 620, 622– 624, 800, 802, 804, 807, 1096– 1122</p>	System Fault	<p>Wait for the inverter to return to normal.</p> <p>Disconnect the AC and DC switches, and reconnect the AC and DC switches 15 minutes later to restart the inverter. If the fault still exists, contact Sungrow Customer Service.</p>

Fault code	Fault name	Corrective measures
59, 70–74, 76, 82, 83, 89, 77–81, 216–218, 220–232, 432–434, 500–513, 515–518, 900, 901, 910, 911	System Alarm	<p>1. The inverter can continue running.</p> <p>2. Check whether the related wiring and terminal are abnormal, check whether there are any foreign materials or other environmental abnormalities, and take corresponding corrective measures when necessary.</p> <p>If the fault persists, please contact Sungrow Power Customer Service.</p>
264-283	MPPT Reverse Connection	<p>1. Check whether the corresponding string is of reverse polarity. If so, disconnect the DC switch and adjust the polarity when the string current drops below 0.5 A.</p> <p>2. Contact Sungrow Customer Service if the preceding causes are ruled out and the fault persists.</p> <p>*The code 264 to code 279 are corresponding to string 1 to string 20 respectively.</p>
332-363	Boost Capacitor Over-voltage Alarm	<p>1. The inverter can continue running.</p> <p>2. Check whether the related wiring and terminals are abnormal, check whether there are any foreign materials or other environmental abnormalities, and take corresponding corrective measures when necessary.</p> <p>If the fault persists, please contact Sungrow Power Customer Service.</p>

Fault code	Fault name	Corrective measures
364-395	Boost Capacitor Over-voltage Fault	Disconnect the AC and DC switches, and reconnect the AC and DC switches 15 minutes later to restart the inverter. If the fault still exists, contact Sungrow Customer Service.
1548-1579	String Current Reflux	<ol style="list-style-type: none"> <li>1. Check whether the number of PV modules of the corresponding string is less than other strings. If so, disconnect the DC switch and adjust the PV module configuration when the string current drops below 0.5 A.</li> <li>2. Check whether the PV module is shaded;</li> <li>3. Disconnect the DC switch to check whether the open circuit voltage is normal when the string current drops below 0.5 A. If so, check the wiring and configuration of the PV module,</li> <li>4. Check whether the orientation of the PV module is abnormal.</li> </ol>

## 9.2 Maintenance

### 9.2.1 Maintenance Notices

The DC switch can be secured with a lock in the OFF position or a certain angle beyond the OFF position.

#### DANGER

**Risk of inverter damage or personal injury due to incorrect service!**

- **Always keep in mind that the inverter is powered by dual sources: PV strings and utility grid.**

**Before any service work, observe the following procedure.**

- **Disconnect the AC circuit breaker and then set the DC switch of the inverter to OFF;**
- **The DC switch can be secured with a lock in the OFF position or a certain angle beyond the OFF position.**
- **Wait at least 10 minutes for inner capacitors to discharge completely;**
- **Verify that there is no voltage or current before pulling any connector.**

**⚠ CAUTION**

**Keep non-related persons away!**

**A temporary warning sign or barrier must be posted to keep non-related persons away while performing electrical connection and service work.**

**NOTICE**

- **Restart the inverter only after removing the fault that impairs safety performance.**
- **As the inverter contains no component parts that can be maintained, never arbitrarily replace any internal components.**
- **For any maintenance need, please contact SUNGROW. Otherwise, SUNGROW shall not be held liable for any damage caused.**



Servicing of the device in accordance with the manual should never be undertaken in the absence of proper tools, test equipments or the latest revision of the manual which has been clearly and thoroughly understood.

### 9.2.2 Routine Maintenance

Item	Method	Period
System clean	Check the temperature and dust of the inverter. Clean the inverter enclosure if necessary.	Six months to a year (depending on the dust contents in air)
Electrical connection	Check whether all cable are firmly connected in place. Check whether there is damage to the cables, especially the surface in contact with metal.	6 months after commissioning and then once or twice a year.
General status of the system	<ul style="list-style-type: none"> <li>• Visual check for any damage or deformation of the inverter.</li> <li>• Check any abnormal noise during the operation.</li> <li>• Check each operation parameter.</li> <li>• Be sure that nothing covers the heat sink of the inverter.</li> </ul>	Every 6 months

### 9.2.3 Fan Maintenance

If the inverter has an external fan, when the fan fails to work normally, the inverter cannot be effectively cooled, which will affect the efficiency of the inverter or cause derated operation. Therefore, keep the fan clean and replace the damaged fan in time.

- step 1 Refer to "[8.1 Disconnecting the Inverter](#)" to stop the inverter.
- step 2 Refer to "[5 Electrical Connection](#)" and disconnect all the cable connections in reverse steps.
- step 3 Refer to "[4 Mechanical Mounting](#)" and dismantle the inverter in reverse steps.
- step 4 Unscrew the screws on the fan bracket.

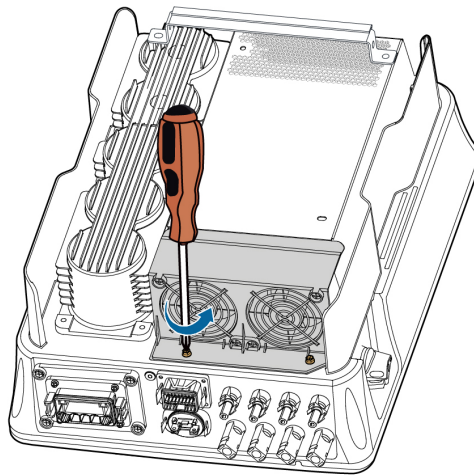

- step 5 Lift the fan bracket upwards, press down the protrusion on the fan power plug connector and pull it outwards, and remove the fan bracket.

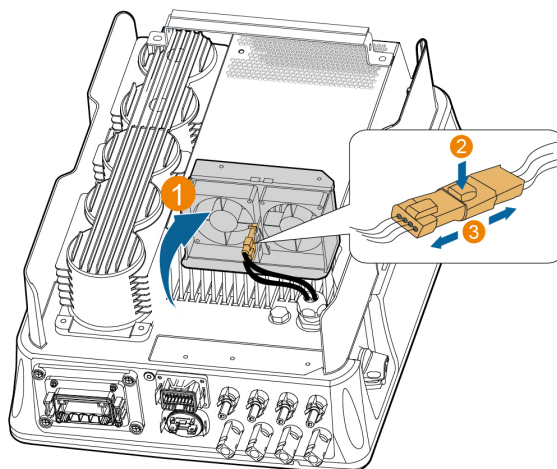

- step 6 Unscrew the screws on the dust covers and remove the dust covers.

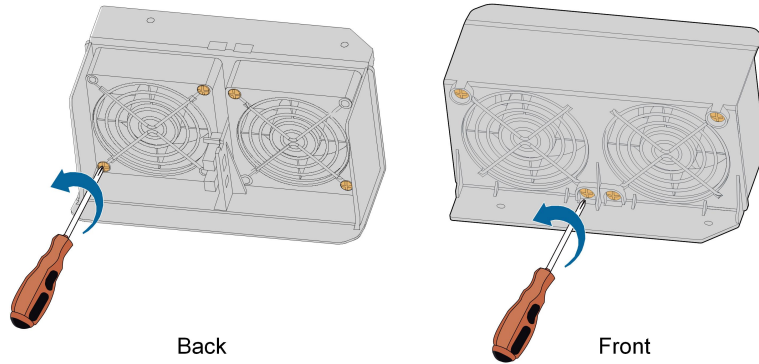

step 7 Use a soft brush or vacuum cleaner to clean the fan. If you need to replace the fan, use a screwdriver to unscrew the screw at the fan bracket and remove the fan.

step 8 Install the dust covers and then the fan bracket to the inverter. Restart the inverter.

**-- End**

# 10 Appendix

## 10.1 Technical Data

Parameter	SG3.0RT	SG4.0RT
<b>Input (DC)</b>		
Recommended max. PV input power	4.5 kWp	6.0 kWp
Max. PV input voltage	1100 V *	
Min. PV input voltage / Start-up input voltage	180V / 180V	
Nominal input voltage	600 V	
MPP voltage range	160 V–1000 V	
No. of independent MPP inputs	2	
No. of PV strings per MPPT	1 / 1	
Max. PV input current	25 A ( 12.5 A / 12.5 A)	
Max. DC short-circuit current	32 A ( 16 A / 16 A)	
<b>Output (AC)</b>		
Nominal AC power (@ 230 V, 50 Hz)	3000 W	4000 W
Max. AC output power	3300VA	4400VA
Max. AC output current	5.1A	6.8A
	3 / N / PE, 220 V / 380 V	
Nominal AC voltage	3 / N / PE, 230 V / 400 V	
	3 / N / PE, 240 V / 415 V	
AC voltage range	180 V–276 V / 311 V–478 V	
Nominal grid frequency / Grid frequency range	50 Hz / (45 Hz–55 Hz)	
	60 Hz / (55 Hz–65 Hz)	
Harmonic (THD)	< 5 % (at nominal power)	
Power factor at nominal power / Adjustable power factor	> 0.99 / 0.8 leading - 0.8 lagging	
Feed-in phases / connection phases	3 / 3	



Parameter	SG3.0RT	SG4.0RT
<b>Efficiency</b>		
Max. efficiency	98.20 %	
European efficiency	96.50 %	97.00 %
<b>Protection &amp; Function</b>		
Grid monitoring	Yes	
DC reverse connection protection	Yes	
AC short-circuit protection	Yes	
Leakage current protection	Yes	
DC switch	Yes	
PID recovery function	Yes	
Surge Protection	DC Type II / AC Type II	
Arc fault circuit interrupter (AFCI)	optional	
<b>General Data</b>		
Dimensions (W x H x D)	370 mm x 480 mm x 195 mm	
Mounting method	Wall-mounting bracket	
Weight	18 kg	
Topology	Transformerless	
Degree of protection	IP65	
Operating ambient temperature range	-25°C to +60°C	
Allowable relative humidity range (non-condensing)	0–100 %	
Max. operating altitude	4000 m (> 2000 m derating)	
Cooling method	Natural cooling	
Display	LED	
Communication	WLAN / Ethernet / RS485 / DI / DO	
DC connection type	MC4 (Max. 6 mm <sup>2</sup> )	
AC connection type	Plug and play	

\* The inverter enters standby state when the input voltage ranges between 1,000 V and 1,100 V. If the maximum DC voltage in the system can exceed 1,000 V, the MC4 connectors included in the scope of delivery must not be used. In this case MC4-Evo2 connectors must be used.

Parameter	SG5.0RT	SG6.0RT
<b>Input (DC)</b>		
Recommended max. PV input power	7.5 kWp	9.0 kWp
Max. PV input voltage	1100 V *	
Min. PV input voltage / Start-up input voltage	180 V / 180 V	
Nominal input voltage	600 V	
MPP voltage range	160 V–1000 V	
No. of independent MPP inputs	2	
No. of of PV strings per MPPT	1 / 1	
Max. PV input current	25 A ( 12.5 A / 12.5 A)	
Max. DC short-circuit current	32 A ( 16 A / 16 A)	
<b>Output (AC)</b>		
Nominal AC power (@ 230 V, 50 Hz)	5000 W	6000 W
Max. AC output power	5000 VA for "AU", "BE", "DE", 5500 VA for others	6000 VA for "AU", "BE", "DE", 6600 VA for others
Rated AC output apparent power	5000 VA for "AU", "BE", "DE", 5500 VA for others	6000 VA for "AU", "BE", "DE", 6600 VA for others
Max. AC output current	7.6 A for "AU", 8.3 A for others	9.1 A for "AU", 10 A for others
Nominal AC voltage	3 / N / PE, 220 V / 380 V 3 / N / PE, 230 V / 400 V 3 / N / PE, 240 V / 415 V	
AC voltage range	180 V–276 V / 311 V–478 V	
Nominal grid frequency / Grid frequency range	50 Hz / (45 Hz–55 Hz) 60 Hz / (55 Hz–65 Hz)	
Harmonic (THD)	< 3 % (at rated power)	
Power factor at nominal power / Adjustable power factor	> 0.99 / 0.8 leading – 0.8 lagging	
Feed-in phases / connection phases	3 / 3–PE	
<b>Efficiency</b>		

Parameter	SG5.0RT	SG6.0RT
Max. efficiency	98.40 %	
European efficiency	97.40 %	
<b>Protection &amp; Function</b>		
Grid monitoring	Yes	
DC reverse connection protection	Yes	
AC short-circuit protection	Yes	
Leakage current protection	Yes	
DC switch	optional**	
PID recovery function	Yes	
Surge Protection	DC Type II / AC Type II	
Arc fault circuit interrupter (AFCI)	optional	
<b>General Data</b>		
Dimensions (W x H x D)	370 mm x 480 mm x 195 mm	
Mounting method	Wall-mounting bracket	
Weight	18 kg	
Topology	Transformerless	
Degree of protection	IP65	
Operating ambient temperature range	-25°C to +60°C	
Allowable relative humidity range (non-condensing)	0–100 %	
Max. operating altitude	4000 m (> 2000 m derating)	
Cooling method	Natural cooling	
Display	LED	
Communication	WLAN / Ethernet / RS485 / DI / DO	
DC connection type	MC4 (Max. 6 mm <sup>2</sup> )	
AC connection type	Plug and play	
Country of manufacture	China	

\* The inverter enters standby state when the input voltage ranges between 1,000 V and 1,100 V. If the maximum DC voltage in the system can exceed 1,000 V, the MC4 connectors included in the scope of delivery must not be used. In this case MC4-Evo2 connectors must be used.

\*\* For inverters without a DC switch, it is necessary to prepare an external DC switch according to AS 60947.3.

Parameter	SG7.0RT	SG8.0RT
<b>Input (DC)</b>		
Recommended max. PV input power	10.5 kWp	12 kWp
Max. PV input voltage	1100 V *	
Min. PV input voltage / Start-up input voltage	180 V / 180 V	
Nominal input voltage	600 V	
MPP voltage range	160 V–1000 V	
No. of independent MPP inputs	2	
No. of PV strings per MPPT	2 / 1	
Max. PV input current	37.5 A ( 25 A / 12.5 A)	
Max. DC short-circuit current	48 A ( 32 A / 16 A)	
<b>Output (AC)</b>		
Nominal AC power (@ 230 V, 50 Hz)	6999 W for "AU", 7000 W for others	8000 W
Max. AC output power	6999 VA for "AU", 7000 VA for "BE", "DE", 7700 VA for others	8000 VA for "AU", "BE", "DE", 8800 VA for others
Rated AC output apparent power	6999 VA for "AU", 7000 VA for "BE", "DE", 7700 VA for others	8000 VA for "AU", "BE", "DE", 8800 VA for others
Max. AC output current	10.6 A for "AU", 11.7 A for others	12.2 A for "AU", 13.3 A for others
Nominal AC voltage	3 / N / PE, 220 V / 380 V 3 / N / PE, 230 V / 400 V 3 / N / PE, 240 V / 415 V	
AC voltage range	180 V–276 V / 311 V–478 V	
Nominal grid frequency / Grid frequency range	50 Hz / (45 Hz–55 Hz) 60 Hz / (55 Hz–65 Hz)	
Harmonic (THD)	< 3 % (at rated power)	
Power factor at nominal power / Adjustable power factor	> 0.99 / 0.8 leading – 0.8 lagging	
Feed-in phases / connection phases	3 / 3–PE	

Parameter	SG7.0RT	SG8.0RT
<b>Efficiency</b>		
Max. efficiency	98.40 %	98.50 %
European efficiency	97.70 %	97.80 %
<b>Protection &amp; Function</b>		
Grid monitoring	Yes	
DC reverse connection protection	Yes	
AC short-circuit protection	Yes	
Leakage current protection	Yes	
DC switch	optional**	
PID recovery function	Yes	
Surge protection	DC Type II, AC Type II	
Arc fault circuit interrupter (AFCI)	optional	
<b>General Data</b>		
Dimensions (W x H x D)	370 mm x 480 mm x 195 mm	
Mounting method	Wall-mounting bracket	
Weight	18 kg	
Topology	Transformerless	
Degree of protection	IP65	
Operating ambient temperature range	-25°C to +60°C	
Allowable relative humidity range (non-condensing)	0–100 %	
Max. operating altitude	4000 m (> 2000 m derating)	
Cooling method	Natural cooling	
Display	LED	
Communication	WLAN / Ethernet / RS485 / DI / DO	
DC connection type	MC4 (Max. 6 mm <sup>2</sup> )	
AC connection type	Plug and play	
Country of manufacture	China	

\* The inverter enters standby state when the input voltage ranges between 1,000 V and 1,100 V. If the maximum DC voltage in the system can exceed 1,000 V, the MC4 connectors included in the scope of delivery must not be used. In this case MC4-Evo2 connectors must be used.

\*\* For inverters without a DC switch, it is necessary to prepare an external DC switch according to AS 60947.3.

Parameter	SG10RT	SG12RT
<b>Input (DC)</b>		
Recommended max. PV input power	15.0 kWp	18.0 kWp
Max. PV input voltage	1100 V *	
Min. PV input voltage / Start-up input voltage	180 V / 180 V	
Nominal input voltage	600 V	
MPP voltage range	160 V–1000 V	
No. of independent MPP inputs	2	
No. of PV strings per MPPT	2 / 1	
Max. PV input current	37.5 A ( 25 A / 12.5 A)	
Max. DC short-circuit current	48 A ( 32 A / 16 A)	
<b>Output (AC)</b>		
Nominal AC power (@ 230 V, 50 Hz)	10000 W	12000 W
Max. AC output power	10000 VA for "AU", "BE", "DE", 11000 VA for others	12000 VA for "AU", "BE", "DE", 13200 VA for others
Rated AC output apparent power	10000 VA for "AU", "BE", "DE", 11000 VA for others	12000 VA for "AU", "BE", "DE", 13200 VA for others
Max. AC output current	15.2 A for "AU", 16.7 A for others	18.2 A for "AU", 20.0 A for others
Nominal AC voltage	3 / N / PE, 220 V / 380 V 3 / N / PE, 230 V / 400 V 3 / N / PE, 240 V / 415 V	
AC voltage range	180 V–276 V / 311 V–478 V	
Nominal grid frequency / Grid frequency range	50 Hz / (45 Hz–55 Hz) 60 Hz / (55 Hz–65 Hz)	
Harmonic (THD)	< 3 % (at rated power)	
Power factor at nominal power / Adjustable power factor	> 0.99 / 0.8 leading–0.8 lagging	
Feed-in phases / connection phases	3 / 3–PE	
<b>Efficiency</b>		
Max. efficiency	98.50 %	

Parameter	SG10RT	SG12RT
European efficiency	97.90 %	
<b>Protection &amp; Function</b>		
Grid monitoring	Yes	
DC reverse connection protection	Yes	
AC short circuit protection	Yes	
Leakage current protection	Yes	
DC switch	optional**	
PID recovery function	Yes	
Surge protection	DC Type II / AC Type II	
Arc fault circuit interrupter (AFCI)	optional	
<b>General Data</b>		
Dimensions (W x H x D)	370 mm x 480 mm x 195 mm	
Mounting method	Wall-mounting bracket	
Weight	18 kg	
Topology	Transformerless	
Degree of protection	IP65	
Operating ambient temperature range	-25°C to +60°C	
Allowable relative humidity range (non-condensing)	0–100 %	
Max. operating altitude	4000 m (> 2000 m derating)	
Cooling method	Natural cooling	
Display	LED	
Communication	WLAN / Ethernet / RS485 / DI / DO	
DC connection type	MC4 (Max. 6 mm <sup>2</sup> )	
AC connection type	Plug and play	
Country of manufacture	China	

\* The inverter enters standby state when the input voltage ranges between 1,000 V and 1,100 V. If the maximum DC voltage in the system can exceed 1,000 V, the MC4 connectors included in the scope of delivery must not be used. In this case MC4-Evo2 connectors must be used.

\*\* For inverters without a DC switch, it is necessary to prepare an external DC switch according to AS 60947.3.

Parameter	SG15RT	SG17RT	SG20RT
<b>Input (DC)</b>			
Recommended max. PV input power	22.5 kWp	25.5 kWp	30.0 kWp
Max. PV input voltage	1100 V *		
Min. PV input voltage / Start-up input voltage	180 V / 180 V		
Nominal input voltage	600 V		
MPP voltage range	160 V–1000 V		
No. of independent MPP inputs	2		
No. number of PV strings per MPPT	2 / 2		
Max. PV input current	50 A ( 25 A / 25 A)		
Max. DC short-circuit current	64 A ( 32 A / 32 A)		
<b>Output (AC)</b>			
Nominal AC power (@ 230 V, 50 Hz)	15000 W	17000 W	20000 W
Max. AC output power	15000 VA for "AU", "BE", "DE", 16500 VA for others	17000 VA for "AU", "BE", "DE", 18700 VA for others	20000 VA for "AU", "BE", "DE", 22000 VA for others
Rated AC output apparent power	15000 VA for "AU", "BE", "DE", 16500 VA for others	17000 VA for "AU", "BE", "DE", 18700 VA for others	20000 VA for "AU", "BE", "DE", 22000 VA for others
Max. AC output current	22.7 A for "AU", 25 A for others	25.8 A for "AU", 28.3 A for others	30.3 A for "AU", 31.9 A for others
Nominal AC voltage	3 / N / PE, 220 V / 380 V 3 / N / PE, 230 V / 400 V 3 / N / PE, 240 V / 415 V		
AC voltage range	180 V–276 V / 311 V–478 V		
Nominal grid frequency / Grid frequency range	50 Hz / (45 Hz–55 Hz) 60 Hz / (55 Hz–65 Hz)		
Harmonic (THD)	< 3 % (at nominal power)		



Parameter	SG15RT	SG17RT	SG20RT
Power factor at nominal power / Adjustable power factor	> 0.99 / 0.8 leading–0.8 lagging		
Feed-in phases / connection phases	3 / 3		
<b>Efficiency</b>			
Max. efficiency	98.50 %		
European efficiency	98.10 %		
<b>Protection &amp; Function</b>			
Grid monitoring	Yes		
DC reverse connection protection	Yes		
AC short-circuit protection	Yes		
Leakage current protection	Yes		
DC switch	optional**		
PID recovery function	Yes		
Surge protection	DC Type II / AC Type II		
Arc fault circuit interrupter (AFCI)	optional		
<b>General Data</b>			
Dimensions (W x H x D)	370 mm x 480 mm x 195 mm		
Mounting method	Wall-mounting bracket		
Weight	21 kg		
Topology	Transformerless		
Degree of protection	IP65		
Operating ambient temperature range	-25°C to +60°C		
Allowable relative humidity range (non-condensing)	0–100 %		
Max. operating altitude	4000 m (> 2000 m derating)		
Cooling method	Smart forced air cooling		
Display	LED		
Communication	WLAN / Ethernet / RS485 / DI / DO		
DC connection type	MC4 (Max. 6 mm <sup>2</sup> )		
AC connection type	Plug and play		
Country of manufacture	China		

\* The inverter enters standby state when the input voltage ranges between 1,000 V and 1,100 V. If the maximum DC voltage in the system can exceed 1,000 V, the MC4 connectors included in the scope of delivery must not be used. In this case MC4-Evo2 connectors must be used.

\*\* For inverters without a DC switch, it is necessary to prepare an external DC switch according to AS 60947.3.

## 10.2 Quality Assurance

When product faults occur during the warranty period, SUNGROW will provide free service or replace the product with a new one.

### Evidence

During the warranty period, the customer shall provide the product purchase invoice and date. In addition, the trademark on the product shall be undamaged and legible. Otherwise, SUNGROW has the right to refuse to honor the quality guarantee.

### Conditions

- After replacement, unqualified products shall be processed by SUNGROW.
- The customer shall give SUNGROW a reasonable period to repair the faulty device.

### Exclusion of Liability

In the following circumstances, SUNGROW has the right to refuse to honor the quality guarantee:

- The free warranty period for the whole machine/components has expired.
- The device is damaged during transport.
- The device is incorrectly installed, refitted, or used.
- The device operates in harsh conditions beyond those described in this manual.
- The fault or damage is caused by installation, repairs, modification, or disassembly performed by a service provider or personnel not from SUNGROW.
- The fault or damage is caused by the use of non-standard or non-SUNGROW components or software.
- The installation and use range are beyond stipulations of relevant international standards.
- The damage is caused by unexpected natural factors.

For faulty products in any of above cases, if the customer requests maintenance, paid maintenance service may be provided based on the judgment of SUNGROW.

## 10.3 Contact Information

Should you have any question about this product, please contact us.

We need the following information to provide you the best assistance:

- Model of the device
- Serial number of the device
- Date of the device
- Fault code/name
- Brief description of the problem

---

**China (HQ)**

Sungrow Power Supply Co., Ltd  
Hefei  
+86 551 65327834  
[service@sungrowpower.com](mailto:service@sungrowpower.com)

**Australia**

Sungrow Australia Group Pty. Ltd.  
Sydney  
+61 2 9922 1522  
[service@sungrowpower.com.au](mailto:service@sungrowpower.com.au)

---

**Brazil**

Sungrow Do Brasil  
Sao Paulo  
+55 0800 677 6000  
[latam.service@sungrowamericas.com](mailto:latam.service@sungrowamericas.com)

**France**

Sungrow France  
Lyon  
+33420102107  
[service@sungrow-emea.com](mailto:service@sungrow-emea.com)

---

**Germany, Austria, Switzerland**

Sungrow Deutschland GmbH  
Munich  
+49 (0)89 1307 2620  
[service@sungrow-emea.com](mailto:service@sungrow-emea.com)

**Greece**

Service Partner – Survey Digital  
+30 2391052757  
[service@sungrow-emea.com](mailto:service@sungrow-emea.com)

---

**India**

Sungrow (India) Private Limited  
Gurgaon  
+91 080 41201350  
[service@in.sungrowpower.com](mailto:service@in.sungrowpower.com)

**Italy**

Sungrow Italy  
Verona  
+39 0800 974739 (Residential)  
+39 045 4752117 (Others)  
[service@sungrow-emea.com](mailto:service@sungrow-emea.com)

---

**Japan**

Sungrow Japan K.K.  
Tokyo  
+ 81 3 6262 9917  
[service@jp.sungrowpower.com](mailto:service@jp.sungrowpower.com)

**Korea**

Sungrow Power Korea Limited  
Seoul  
+82 70 7719 1889  
[service@kr.sungrowpower.com](mailto:service@kr.sungrowpower.com)

---

<p><b>Malaysia</b></p> <p>Sungrow SEA Selangor Darul Ehsan +60 19 897 3360 <a href="mailto:service@my.sungrowpower.com">service@my.sungrowpower.com</a></p>	<p><b>Philippines</b></p> <p>Sungrow Power Supply Co., Ltd Mandaluyong City +63 9173022769 <a href="mailto:service@ph.sungrowpower.com">service@ph.sungrowpower.com</a></p>
<p><b>Thailand</b></p> <p>Sungrow Thailand Co., Ltd. Bangkok +66 891246053 <a href="mailto:service@th.sungrowpower.com">service@th.sungrowpower.com</a></p>	<p><b>Spain</b></p> <p>Sungrow Ibérica S.A.U. Mutilva +34 948 05 22 04 <a href="mailto:service@sungrow-emea.com">service@sungrow-emea.com</a></p>
<p><b>Romania</b></p> <p>Service Partner - Elerex <a href="mailto:service@sungrow-emea.com">service@sungrow-emea.com</a></p>	<p><b>Turkey</b></p> <p>Sungrow Deutschland GmbH Turkey Istanbul +90 216 663 61 80 <a href="mailto:service@sungrow-emea.com">service@sungrow-emea.com</a></p>
<p><b>UK</b></p> <p>Sungrow Power UK Ltd. Milton Keynes +44 (0) 01908 414127 <a href="mailto:service@sungrow-emea.com">service@sungrow-emea.com</a></p>	<p><b>U.S.A, Mexico</b></p> <p>Sungrow USA Corporation Phoenix +1 833 747 6937 <a href="mailto:techsupport@sungrow-na.com">techsupport@sungrow-na.com</a></p>
<p><b>Vietnam</b></p> <p>Sungrow Vietnam Hanoi +84 918 402 140 <a href="mailto:service@vn.sungrowpower.com">service@vn.sungrowpower.com</a></p>	<p><b>Belgium, Netherlands and Luxembourg (Benelus)</b></p> <p>+31 853 018 234 (only for Netherlands) <a href="mailto:service@sungrow-emea.com">service@sungrow-emea.com</a></p>
<p><b>Poland</b></p> <p>+48 221530484 <a href="mailto:service@sungrow-emea.com">service@sungrow-emea.com</a></p>	-