



ZDNY Series User Manual



EN



SolaX Power Co., Ltd.

No.288 Shizhu Road, Tonglu Economic Development Zone,
Tonglu City, Zhejiang province, China.

Tel: +86 0571-56260011

E-mail: info@solaxpower.com

www.solaxpower.com

614.00010.03

Copyright Declaration

The copyright of this manual belongs to SolaX Power Co., Ltd.. Any corporation or individual should not plagiarize, partially copy or fully copy it (including software, etc.), and no reproduction or distribution of it in any form or by any means. All rights reserved. SolaX Power Co., Ltd. reserves the right of final interpretation. This information is subject to changes without notice.

www.solaxpower.com

Contents

1 NOTES ON THIS MANUAL	03
1.1 SCOPE OF VALIDITY	03
1.2 TARGET GROUP	03
1.3 SYMBOLS USED	03
2 SAFETY	04
2.1 APPROPRIATE USAGE	04
2.2 IMPORTANT SAFETY INSTRUCTIONS	05
2.3 EXPLANATION OF SYMBOLS	06
2.4 EC DIRECTIVES	09
3 INTRODUCTION	10
3.1 BASIC FEATURE	10
3.2 TERMINALS OF PV INVERTER	10
3.3 DIMENSION	11
3.4 IDENTIFICATION OF ZDNY	11
4 TECHNICAL DATA	12
4.1 DC INPUT	12
4.2 AC OUTPUT	13
4.3 EFFICIENCY, SAFETY AND PROTECTION	13
4.4 GENERAL DATA	14
5 INSTALLATION	14
5.1 UN PACKING	14
5.2 CHECK FOR TRANSPORT DAMAGE	16
5.3 INSTALLATION PRECAUTION	16
5.4 PREPARATION	17
5.5 INSTALLATION STEPS	18
5.6 CONNECTIONS OF THE PV POWER SYSTEM	19
5.7 RUN THE INVERTER	31

6 OPERATION METHOD	31
6.1 CONTROL PANEL	31
6.2 LCD FUNCTION	32
6.3 LCD OPERATION	32
7 TROUBLESHOOTING	40
7.1 TROUBLE SHOOTING	40
7.2 ROUTINE MAINTENANCE	44
8 DECOMMISSIONING	45
8.1 DISMANTLING THE INVERTER	45
8.2 PACKAGING	45
8.3 STORAGE	45
8.4 DISPOSAL	46

1 Notes on this Manual

1.1 Scope of Validity

This manual is an integral part of inverter, It describes the assembly, installation, commissioning, maintenance and failure search of the below inverters. Please read it carefully before operating.

ZDNY-TL10000 ZDNY-TL12000 ZDNY-TL15000 ZDNY-TL17000
ZDNY-TL20000

Store this manual where it will be accessible at all times.

1.2 Target Group

This manual is for qualified electricians. The tasks described in this manual only can be performed by qualified electricians.

1.3 Symbols Used

The following types of safety instructions and general information appear in this document as described below:



DANGER !

"Danger" indicates a hazardous situation which, if not avoided, will result in death or serious injury.



WARNING !

"Warning" indicates a hazardous situation which, if not avoided, could result in death or serious injury.



CAUTION !

"Caution" indicates a hazardous situation which, if not avoided, could result in minor or moderate injury.



NOTE !

"Note" provides tips that are valuable for the optimal operation of your product.

2 Safety

2.1 Appropriate Usage

The ZDNY Series is a PV inverter which converts the DC current of a PV generator into AC current and feeds it into the public grid.

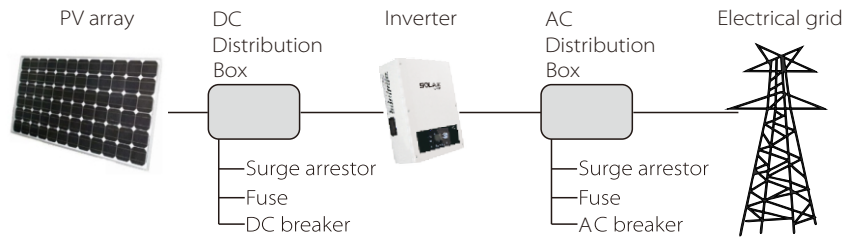

Surge protection devices (SPDs) for PV installation



WARNING !

Over-voltage protection with surge arresters should be provided when the PV power system is installed. The grid connected inverter is not fitted with SPDs in both PV input side and MAINS side.

Lightning can cause damage either from direct strike or from surges due to a nearby strike.

Induced surges are the more likely cause of lightning damage in the majority of installations, especially in rural areas where electricity is usually by long overhead lines. Surges may be induced on both the PV array conduction and the a.c. cables leading to the building.

Specialists in lightning protection should be consulted during the end use application. Using appropriate external lightning protection, the effect of a direct lightning strike into a building can be mitigated in a controlled way, and the lightning current can be discharged into the ground.

Installation of SPDs to protect the inverter against mechanical damage and

excessive stress include a surge arrester in case of a building with external lightning protection system (LPS) when separation distance is kept.

To protect the d.c. system, surge suppression device (SPD type2) should be fitted at the inverter end of the d.c. cabling and at the array, located between the inverter and the PV generator, if the voltage protection level (VP) of the surge arresters is greater than 1100V, a additional SPD type 3 required for surge protection for electrical devices.

To protect the a.c. system, surge suppression devices (SPD type2) should be fitted at the main incoming point of a.c supply (at the consumer's cutout), located between the inverter and the meter/distribution system; SPD (test impulse D1) for signal line according to EN 61643-21.

All d.c cables should be installed to provide as short runs as possible, and positive and negative cables of the same string or main d.c supply should be bundled together, avoiding the creation of loops in the system. This requirement for short runs and bundling includes any associated earth/bundling conductors.

Spark gap devices are not suitable to be used in d.c circuits as once conducting, they won't stop conducting until the voltage across their terminals is typically more than 30 volts.

2.2 Important Safety Instructions



**DANGER !
DANGER TO LIFE DUE TO HIGH VOLTAGES IN THE INVERTER !**

- All work on the inverter must be carried out by qualified electrician.
- The appliance is not to be used by children or persons with reduced physical sensory or mental capabilities, or lack of experience and knowledge, unless they have been given supervision or instruction.
- Children should be supervised to ensure that they do not play with the appliance.



**CAUTION !
DANGER OF BURN INJURIES DUE TO HOT ENCLOSURE PARTS !**

- During operation, the upper lid of the enclosure and the enclosure body may become hot.
- Only touch the lower enclosure lid during operation.



**CAUTION !
POSSIBLE DAMAGE TO HEALTH AS A RESULT OF THE EFFECTS OF RADIATION !**

- Do not stay closer than 20 cm to the inverter for any length of time.

NOTE !
 Grounding the PV generator.
 Comply with the local requirements for grounding the PV modules and the PV generator. SolaX recommends connecting the generator frame and other electrically conductive surfaces in a manner which ensures continuous conduction and ground these in order to have optimal protection of the system and persons.

2.3 Explanation of Symbols

This section gives an explanation of all the symbols shown on the inverter and on the type label.

• Symbols on the Inverter

Symbol	Explanation
	Operating Display
	Communication is active.
	An error has occurred, please inform your installer immediately.

• Symbols on the Type Label

Symbol	Explanation
	CE mark. The inverter complies with the requirements of the applicable CE guidelines.
	TUV certified.
	RCM remark.
	SAA certification.
	Beware of hot surface. The inverter can become hot during operation. Avoid contact during operation.
	Danger of high voltages. Danger to life due to high voltages in the inverter!

	Danger. Risk of electric shock!
	Observe enclosed documentation.
	The inverter can not be disposed of together with the household waste. Disposal information can be found in the enclosed documentation.
	Don't work on this inverter until it is isolated from both mains and on-site PV generation suppliers.
	Danger to life due to high voltage. There is residual voltage in the inverter which needs 45 min to discharge. • Wait 45 min before you open the upper lid or the DC lid.

• Important Safety Instructions

When using the product, please do remember the below information to avoid the fire, lightning or other personal injury:

WARNING !
 Ensure input DC voltage \leq Max. DC voltage . Over voltage may cause permanent damage to inverter or other losses, which will not be included in warranty! This chapter contains important safety and operating instructions. Read and keep this Operation Guide for future reference.

WARNING !
 Authorized service personnel must disconnect both AC and DC power from the ZDNY Series inverter before attempting any maintenance or cleaning or working on any circuits connected to the ZDNY Series inverter.

- Read all instructions, cautionary markings on the inverter, and all appropriate sections of this manual before using this inverter.
- Use only attachments recommended or sold by SolaX.
- Make sure that existing wiring is in good condition and that wire is not undersized. Do not operate the ZDNY Series inverter with damaged or substandard wiring.
- Do not disassemble the ZDNY Series inverter. It contains no user-serviceable parts. See Warranty for instructions on obtaining service. Attempting to service the ZDNY Series inverter yourself may result in a risk of electric shock or fire and will void your warranty.
- Keep away from flammable, explosive materials to avoid fire disaster.
- The installation place should be away from humid or corrosive substance.

- Authorized service personnel must use insulated tools when installing or working with this equipment.
 - PV modules shall have an IEC 61730 class A rating.
- PE Connection and leakage current**
- The end-use application shall monitoring of the protective conductor by residual current operated protective device (RCD) with rated fault current $I_{fn} \leq 100\text{mA}$ which automatically disconnects the device in case of a fault.
 - DC differential currents are created (caused by insulation resistance and through capacities of the PV generator). In order to prevent unwanted triggering during operation, the rated residual current of the RCD has to be $\geq 100\text{mA}$.
 - The device is intended to connect to a PV generator with a capacitance limit of approx 700nF.



WARNING !

High leakage current!
Earth connection essential before connecting supply.

- Incorrect grounding can cause physical injury, death or equipment malfunction and increase electromagnetic interference.
- Make sure that grounding conductor is adequately sized as required by safety regulations.
- Do not connect the ground terminals of the unit in series in case of a multiple installation. This product can cause current with a d.c component, Where a residual current operated protective (RCD) or monitoring (RCM) device is used for protection in case of direct or indirect contact, only an RCD or RCM of type B is allowed on the supply side of this product.
- For Australia and New Zealand:
The installation of inverter must fulfill Australia national Wiring rules AS/NZS3000, AS/NZS4777.1 and AS/NZS5033.



WARNING !

Do not work on the solar inverter when the device is running.

- Never touch either the positive or negative pole of PV connecting device. And never ever touch both at the same time.



WARNING !

Risk of electric shock!

- The unit contains capacitors that remain charged to a potentially lethal voltage after the MAINS and PV supply has been disconnected.
- Hazardous voltage will present for up to 45 minutes after disconnection from

- power supply.
- CAUTION-RISK of electric shock from energy stored in capacitor, never work on the solar inverter couplers, the MAINS cable, PV cables or the PV generator when power is applied. After switching off the PV power and Mains, always wait for 15 minutes to let the intermediate circuit capacitors discharge before you unplug DC input and MAINS couplers.
- When access to internal circuit of solar inverter, it is very important to wait 45 minutes before working on power circuit or demounting the electrolyte capacitors inside the device. Do not open the device before hand since the capacitors require this long to discharge sufficiently!
- Measure the voltage between terminals UDC+ and UDC with a multi-meter (impedance at least 1Mohm) to ensure that the device is discharged before beginning work (35VDC) inside the device.

2.4 EC Directives

This chapter follows the requirements of the European Low Voltage Directives, which contains the safety instructions and conditions of acceptability for the enduse system, which you must follow when installing, operating and servicing the unit. If ignored, physical injury or death may follow, or damage may occur to the unit. Read this instructions before you work on the unit. If you are unable to understand the dangers, warnings, cautions or instructions, contact the manufacture if an authorized service dealer before installing, operating and servicing the unit.

The grid connected inverter meets the requirement stipulated in Low Voltage Directive (LVD) 2006/95/EC and Electromagnetic Compatibility (EMC) Directive 2004/108/EC. The unit is tested based on:

EN 50178:1997	EN 62109-1:2010	EN 62109-2:2011
VDE 0126-1-1:2006	VDE 4105:2011	

In case of installation in PV system, startup of the unit (i.e. start of designated operation) is prohibited until it is determined that the full system meets the requirements stipulated in EC Directive (2006/95/EC, 2004/108/EC, etc.)

The grid connected inverter leaves the factory completely connecting device and ready for connection to the mains and PV supply. The unit shall be installed in accordance with national wiring regulations. Compliance with safety regulations depends upon installing and configuring system correctly, including using the specified wirings. The system must be installed only by professional assemblers who are familiar with requirements for safety and EMC. The assembler is responsible for ensuring that the end system complies with all the relevant laws in the country where it is to be used.

The individual subassembly of the system shall be interconnected by means of the wiring methods outlined in national/international such as the National Electric code (NFPA) No.70 or VDE regulation 0107.

3 Introduction

3.1 Basic Features

Congratulations on your purchase of a ZDNY Series inverter from SolaX. The ZDNY inverter is one of the finest inverter on the market today, incorporating state-of-the-art technology, high reliability, and convenient control features.

- Advanced DSP control technology.
- Utilize the latest high-efficiency power component.
- Optimal MPPT technology.
 - Two independent MPP Tracking.
 - Wide MPPT input range.
- Advanced anti-islanding solutions.
- Anti-theft protection.
- IP65 protection level.
- Max. efficiency up to 98.2%. EU efficiency up to 97.6%.
- THD < 3%.
- Safety & Reliability: transformerless design with software and hardware protection.
- Export control.
- Power factor regulation.
- Friendly HMI.
 - LED status indications
 - LCD display technical data, Human-machine interaction through press key.
 - RS485/RS232, dry contact communication interface.
 - PC remote control.

3.2 Terminals of PV inverter

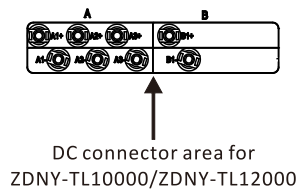
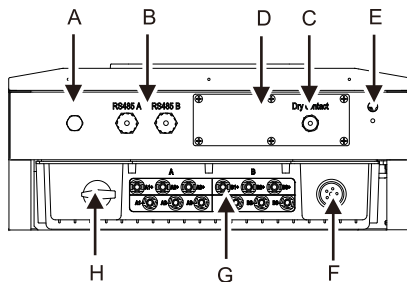

Object	Description
A	Valve for releasing the air.
B	Cables opening for RS485 connection
C	Cable opening for dry contact.
D	Communication lid. (Open the lid to set the RS232.)
E	Ground terminal for additional grounding the inverter.
F	AC connector
G	DC connector area. (ZDNY-TL15000/17000/20000)
H	DC switch



WARNING !

Only qualified electricians can operate the connection.

3.3 Dimensions

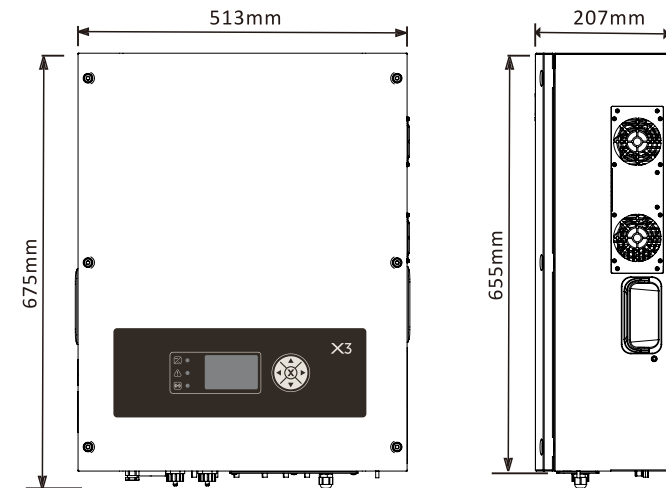

3.4 Identification of ZDNY

You can identify the ZDNY Series inverter using the name plate in the right side of the inverter.

Model Name	Parameter	Series Number	Labels
<p>Model: ZDNY-TL 17000</p> <p>Max. DC voltage 1000 V</p> <p>Rated input voltage 640 V</p> <p>MPP voltage range 250-800 V</p> <p>Max. DC current (Input A/Input B) 22 A/22 A</p> <p>Absolute max. total PV array short circuit current (Input A/Input B) 25 A/25 A</p> <p>Max. DC power (@ cosφ=1) 17420 W</p> <p>Nominal AC voltage 3/N/PE ~ 400/230 V</p> <p>Nominal AC current 3×24.6 A</p> <p>Max. continuous AC current 3×25 A</p> <p>Rated AC power (@ 230 V, 50 Hz) 17000 W</p> <p>Max. apparent AC power 17000 VA</p> <p>Nominal AC grid frequency 50 Hz</p> <p>Power factor at rated power 1</p> <p>Adjustable displacement factor range 0.90 over-excited... 0.90 under-excited</p> <p>Operating ambient temperature range -20 °C ~ +60 °C</p> <p>Ingress protection IP54 (Front), IP65 (Other)</p> <p>Protective class I</p> <p>Over voltage category III (MAINS), II (PV)</p> <p>VDE-AR-N 4105 / RD1699 / C10/11 / G59/2 / LTE 15712 / EN50438 / VDE0126-1-1</p>	<p>Max. continuous AC current 3 AC current</p> <p>Rated AC power (@ 230 V, 50 Hz) 17000 VA</p> <p>Max. apparent AC power 17000 VA</p> <p>Nominal AC grid frequency 50 Hz</p> <p>Power factor at rated power 1</p> <p>Adjustable displacement factor range 0.90 over-excited... 0.90 under-excited</p> <p>Operating ambient temperature range -20 °C ~ +60 °C</p> <p>Ingress protection IP54 (Front), IP65 (Other)</p> <p>Protective class I</p> <p>Over voltage category III (MAINS), II (PV)</p> <p>Grid monitoring AS4777 / VDE-AR-N 4105 / RD1699 / C10/11 / G59/2 / LTE 15712 / EN50438 / VDE0126-1-1</p> <p>S/N:</p> <p>SolaX Power Co., Ltd. ADD: No.288 Shuhua Road, Tonglu Economic Development Zone, Zhejiang Province, China. TEL: +86 571 2850 9376 E-mail: info@solaX.com www.solaXpower.com</p> <p>MADE IN CHINA</p>	<p>Manufacture Info</p>	

4 Technical Data

4.1 DC Input

Model	ZDNY-TL 10000	ZDNY-TL 12000	ZDNY-TL 15000	ZDNY-TL 17000	ZDNY-TL 20000
Max. DC input power (W)	10260	12300	15370	17420	20500
Max. DC input Voltage(V)	1000	1000	1000	1000	1000
Min. DC input Voltage(V)	250	250	250	250	250
MPP voltage range(V)	320-800	380-800	350-800	400-800	480-800
Rated input voltage(V)	640	640	640	640	640
Start input voltage(V)	220	220	220	220	220
Max. DC input current A	22	22	22	22	22
Max. DC input current B	11	11	22	22	22
Max. short-circuit current A	30	30	30	30	30
Max. short-circuit current B	15	15	30	30	30
No. of MPP inputs	2	2	2	2	2
Strings per MPP input A	3	3	3	3	3
Strings per MPP input B	1	1	3	3	3

4.2 AC Output

Model	ZDNY-TL 10000	ZDNY-TL 12000	ZDNY-TL 15000	ZDNY-TL 17000	ZDNY-TL 20000
Rated output power (V)	10000	12000	15000	17000	20000
Max. apparent AC power(VA)	10000	12000	15000	17000	20000
Rated grid voltage(V)	3/N/PE~230/400V				
AC voltage range(V)	160-280				
AC nominal current(A)	14.5	17.4	21.7	24.6	29
Max.output current(A)	16	20	24	25	29
Max.short-circuit current(A)	40	40	50	50	50
THD	<3%	<3%	<3%	<3%	<3%
Rated grid frequency(Hz)	50	50	50	50	50
Rated grid frequency range(Hz)	44-55				
Displacement power factor	0.9overexcited~0.9underexcited				
Feed-in phases	3				
Connection phases	3				
Overvoltage catagory	III(MAINS),II(PV)				

4.3 Efficiency,Safety and Protectoion

Model	ZDNY-TL 10000	ZDNY-TL 12000	ZDNY-TL 15000	ZDNY-TL 17000	ZDNY-TL 20000
Max. Efficiency	98.2%	98.2%	98.2%	98.2%	98.2%
Euro Efficiency	97.6%	97.6%	97.6%	97.6%	97.6%
MPPT Efficiency	99.9%	99.9%	99.9%	99.9%	99.9%
Safety & Protection	YES				
Over/under voltage Protection	YES				
DC isolation Impedance Protection	YES				
Ground Fault Protection	YES				
Grid Monitoring	YES				
Ground Fault Current monitoring	YES				
DC Injection Monitoring	YES				
Back feed current monitoring	YES				
Residual current detection	YES				
Anti-island protection	YES				
Over load protection	YES				
Over heat protection	YES				

4.4 General Data

Model	ZDNY-TL 10000	ZDNY-TL 12000	ZDNY-TL 15000	ZDNY-TL 17000	ZDNY-TL 20000
Dimension (W/H/D) (mm)	513*675*207				
Weight (kg)	48	48	50.5	50.5	50.5
Dimension of packing (W/H/D)	650*750*350				
Gross weight (kg)	58	58	60.5	60.5	60.5
Cooling concept	Opti Cool:temperature-controlled fan				
Noise emission	<50	<50	<50	<50	<50
Operating temperature range (°C)	-20~+60 (derating at 40)				
Store temperature (°C)	-20~+60				
Altitude (Km)	IP65(IP54 Fan)				
Degree of protection	II				
Topology	Transformer-less				
Internal consumption (W)	<1				
LCD display	LCD graphic display				
Communication interface	RS485/RS232/Dry contact(WIFI optional)				
Standard Warranty	5 years(10 years optional)				

5 Installation

5.1 Unpacking

Check the delivery for completeness. Contact your dealer at once if anything is missing.

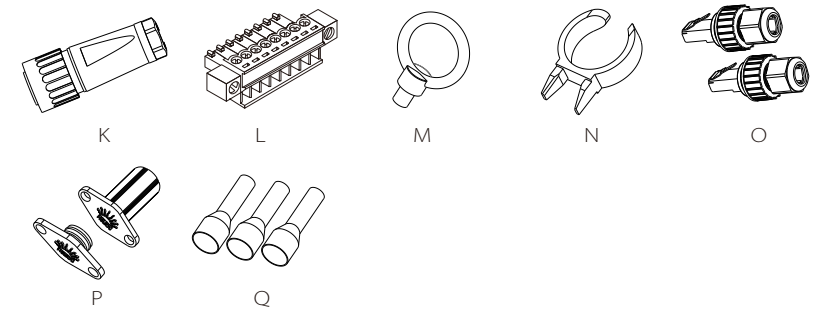
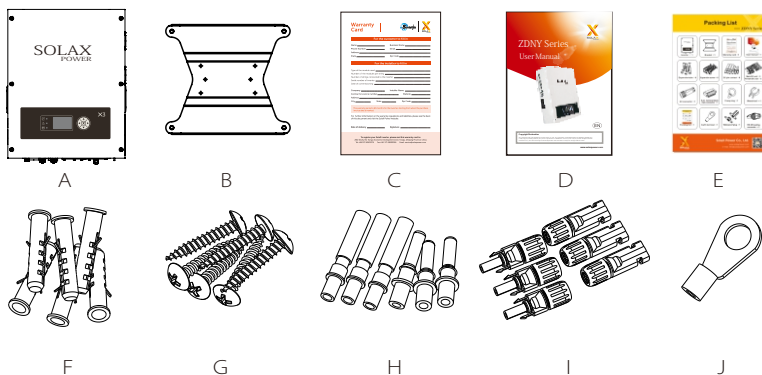

Object	Quantity	Description
A	1	DZNY series inverter
B	1	Bracket
C	1	Warranty card
D	1	User manual
E	1	Packing List
F	6	Expansion screws
G	6	Expansion tubes
H	12	DC pin contact
I	12	DC connectors 6units (6* positive ,6* negative)
J	1	Earth terminal
K	1	AC connector
L	1	8 pin terminal block male connector for dry connector.
M	1	Cramp ring
N	1	Wrench tool for separate DC connector
O	2	RS 485 sealing connector
P	4	Waterproof plug
Q	5	AC pin contact

Open the package and pick the product, check that if there is any distortion or impaired during the transportation. Meanwhile, check that if the relating accessories and the materials are here, you can see the accessories list in the table.

The instruction manual is an integral part of the unit and should therefore be read and kept carefully.

It is recommended that the packaging should not be removed until the unit is located in the installation site.

5.2 Check for transport damage

Check if the ZDNY series inverter has some visible external damage, such as cracks in the housing or display please contact with your dealer if you find any damage.

5.3 Installation precaution

The X1-LX series inverter is designed for outdoor installation (IP65)

Make sure the installation site does not fall into none of the following conditions:

- Do not install the inverter in direct sunlight
- Do not install the inverter on flammable construction material
- Do not install the inverter in areas where highly flammable materials are stored.
- Do not install the inverter in potentially explosive areas.
- Do not install the inverter in the cool air directly.
- Do not install the inverter near the television antenna or antenna cable.
- Do not install the inverter in higher than the altitude of about 2,000 m above sea level.
- Do not install the inverter during periods of precipitation or high humidity (>95%); Moisture trapped within the location may cause corrosion and damage to the electric components.
- Install the inverter in a location that maintains an ambient air temperature which is less than 45°C; That is to maintain a safe internal component temperature, the inverter reduce power if the ambient air temperature exceeds 45°C
- The inverter should be installed in a location that is not accessible for children.
- The inverter emits a slight vibrating noise when operating, This noise is normal and no effect on performance.
- The slope of the wall should be within $\pm 5^\circ$.
- Keep the inverter far away from the seawater.
- The inverter is heavy, ensure the mounting place is strong enough to hold the weight of the inverter.
- If you install the inverter in a cabinet, closet or other small enclosed area, sufficient air circulation must be provided in order to dissipate the heat generate by the unit.

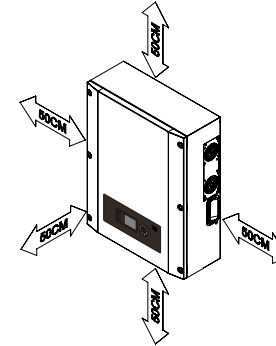

Available space size	
Position	Min.Size
Side	50cm
Top	50cm
Bottom	50cm
Front	50cm

5.4 Preparation

Below tools are needed before installation.



Installation Tools

Installation Tools: crimping pliers for binding post and RJ45, screwdriver, manual wrench, $\phi 8$ drill and rubber hammer.

Lifting and Handling

The unit is heavy. Do not lift it alone.

- During lifting procedures ensure that the unit is firmly secured to avoid the risk of accidental tipping or dropping.
- Parts serving for support or immobilization of unit shall be designed and manufactured so as to minimize the risk of physical injuries and of accidental loosening of fixing.
- Ensure that the method of lifting will not allow the unit to slip from chains and slings or turn-over or slide from lifting devices.
- Transportation must be carried by specialized person (truck operators, hook-up personal), equipped with the necessary protection equipments (overalls, safety shoes, protective gloves, helmets, goggles)
- Do not walk or stand beneath or in the proximity of the load.
- Avoid sudden movements and jolts when unloading and positioning the unit. Internal handling procedures must be conducted with care. Do not exert leverage on the components of the machine.
- If the unit is not balanced apply ballast. Any protruding parts should not be supported by hand.
- The inverter should be installed so that the operating panel shall be easily accessible- easy access to the electrical power connection point.
- Accessible for maintenance and repair work.

- Loading capacity and hardness of the supporting surface, load rating of mounting bracket should be at least four times the weight of the devices according to IEC62109-1. and supporting characteristics will be impaired by wear, corrosion, material fatigue or ageing, This should be calculated by inspection of the design data of supporting material and consulting construction engineer.

5.5 Installation steps

Step1: Screw the wall bracket on the wall

- Use the wall bracket as a template to mark the position of the six holes.
- Drill holes with $\phi 8$ drill carefully, make sure the holes are deep enough for install and tight the expansion tubes.
- Install the expansion tubes in the wall, and screw the wall bracket using the screws in the screw package.

Step 2: Install the anti-theft protection.

- Set the cramp ring into the holes of the bracket and inverter on the right side.

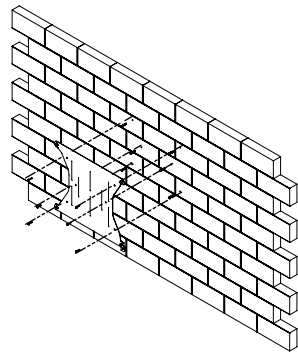

Step1

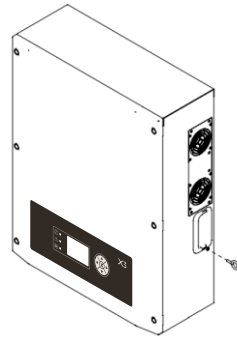

Step2

Step3: Hang the ZDNY inverter onto the wall bracket.

- Transport the inverter need at least 2 people, each one need to use the handles at the sides of the inverter.
- Hang the ZDNY inverter onto the bracket, make sure the support on the bracket is fixed well with the inverter.

Step 4: Install the anti-theft protection

- Lock the inverter and the bracket by the cramp ring using a padlock.

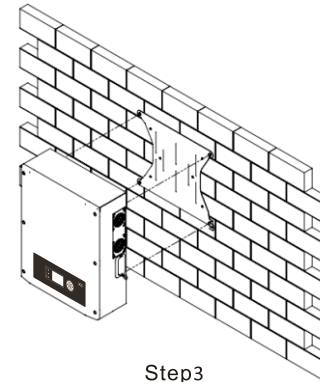

Step3

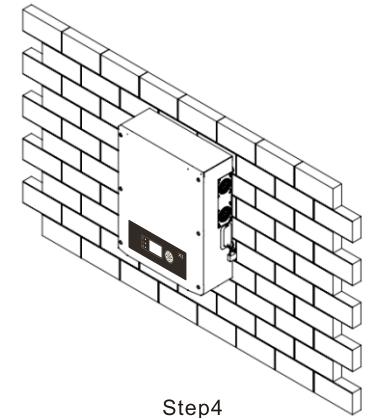

Step4



NOTE !

Please store the key carefully in case the inverter needs service.

5.6 Connections of the PV power system

• PV String



WARNING!

PV module voltage is very high which belongs to dangerous voltage range, please comply with electric safety rules when connecting.



WARNING!

When the photovoltaic array is exposed to light, it supplies a D.C voltage to the PCE.



WARNING!

When there is something wrong with the modules arrays. Modules can be connected with inverter only after eliminating these problems.

ZDNY series inverters has two input areas "A" and "B", each with it's own MPP Tracker, can be connected in series into 2-strings PV modules. Please select PV modules with excellent function and reliable quality. Open-circuit voltage of module arrays connected in series should be <Max. DC input voltage; Operating voltage should be conformed to MPPT voltage range.

Model	ZDNY-TL 10000	ZDNY-TL 12000	ZDNY-TL 15000	ZDNY-TL 17000	ZDNY-TL 20000
Max.DC input voltage(V)	1000				
MPPT voltage range(V)	320-800	380-800	350-800	400-800	480-800

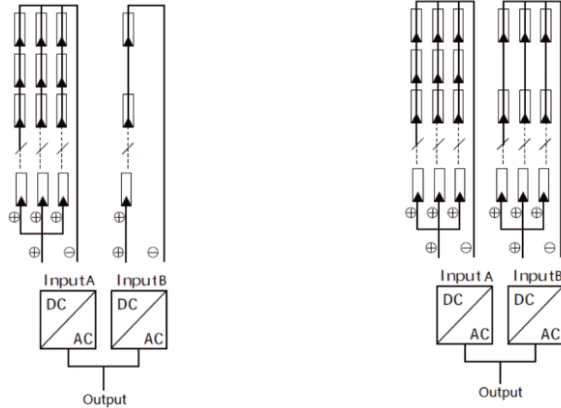

ZDNY-TL10000 and ZDNY-TL12000 with 2 MPP trackers area: A and B. Area A with 3 strings input ,area B with 1 string input.

ZDNY-TL15000 and ZDNY-TL17000 and ZDNY-TL20000 with 2 MPP trackers area A and B each area with 3 strings input

NOTE! The following requirements of PV modules need to be applied for each input area;

- Same type
- Same quantity
- Identical alignment
- Identical Tilt

Please use PV cable to connect modules to inverter. From junction box to inverter, voltage drop is about 1-2%. So we suggest the inverter install near PV module, in order to save cable and reduce DC loss. (No longer than 30m)

NOTE! Please do not make PV positive or negative ground!

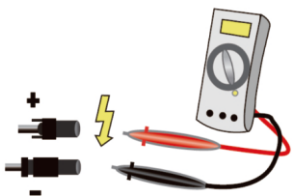

- Use multimeter to measure module array voltage
- Check the PV+ and PV- from the PV string combiner box correctly. Make sure the PV+ and PV- connected correctly.

•Connection Step:

1. Disconnect the DC switch.
2. Choose the 12 AWG wire to connect the PV module.
3. Trip 6mm of insulation from the Wire end.

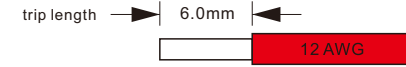

4. Separate the DC connector as below.

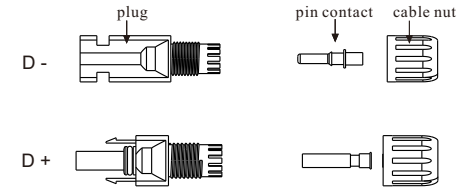

5. Insert striped cable into pin contact and ensure all conductor strands are captured in the pin contact.
6. Crimp pin contact by using a crimping pliers. Put the pin contact with striped cable into the corresponding crimping pliers and crimp the contact.

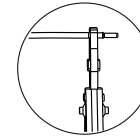

7. Insert pin contact through the cable nut to assemble into back of the male or female plug. When you feel or heard a "click" the pin contact assembly is seated

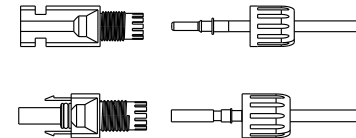

8. Tight the DC connector.
 - a. Slide the cable nut towards the back shell.
 - b. Rotate the cable nut to secure the cable.

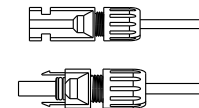

9. After securing the cable tightly, align the 2 half connectors and mate them together

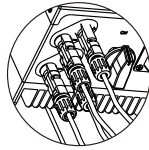

10. Separate the DC connector
 - a. Use the specified wrench tool.
 - b. When separate the DC+ connector, push the tool down from up side.
 - c. When separate the DC- connector, push the tool down from the bottom side.
 - d. Separate the connectors by hands.

WARNING!

Before connecting, disconnecting the connection between solar generator and inverter and locked it to the open position during installation. Place a warning sign "do not turn on maintenance in progress" on the external disconnect switch when it is shut Down, and make sure that on-off remote controls are inhibited.

● AC Output

WARNING!

Must comply with the connection requirement of your distribution grid.

ZDNY series inverters are designed for three phase grid. Voltage range is from $230V \pm 20\%$, according to different countries. The typical frequency is 50Hz. Other technical requests should comply with the requirement of local public grid. For the terminal and cable design please follow below requirements.

Terminal capacity and Identification.

	Connection type	Rated connecting capacity and ratings	Tighting torque	Stripping length
Protective earthing connection	Torx-head Screw(m5)	-----	1.8-2Nm	11mm
DC input connection	Amphenol(MC4)	25A 1000V	1.8-2Nm	-----
AC output connection	Amphenol	25A 380V	1.8-2Nm	-----
RS485	Connector	-----	-----	-----

Earth conductor: PE screw terminal designed for clamping a cable lug or bar by means of a screw, nut and locking washer, before PE connection, strip the conductor end 12mm long to fit them into a cable lug or bar. For PE connection, the length of conductors between the cord anchorage and the terminal, shall be such that the current-carrying conductors became taut before the earthing conductor if the cable slips out of the cord anchorage.

Model	ZDNY-TL 10000	ZDNY-TL 12000	ZDNY-TL 15000	ZDNY-TL 10000	ZDNY-TL 20000
Cable(Cu) (mm ²)	≥6				
Micro-breaker(A)	25	25	32	32	32

●Connection Step:

1. Check the grid voltage and compare with the permissible voltage range. (see technical data).
2. Disconnect the circuit-breaker from all the phases and secure against re-connection.
3. Trip the wires:
 - a. Trip all the wires to 52.5mm and the PE wire to 55mm.
 - b. Use the crimping pliers to trip 12mm of insulation from all wire ends as below.

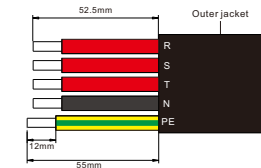

4. Separate the AC plug into three parts as below.
 - a: Hold the middle part of the female insert, rotate the back shell to loosen it, and detach it from female insert.
 - b: Remove the cable nut (with rubber insert) from the back shell.

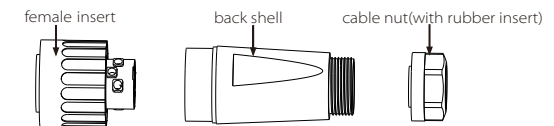

- 5: Slide the cable nut and then back shell onto the cable.



6. Insert striped cable into AC terminal and insure all conductor strands are captured in the AC terminal. Compress the AC terminal head by using a crimping pliers and screw down screw cap tight. Cable core section after crimp should be the section as below.

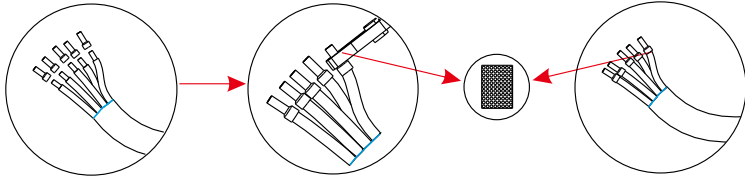

7. Insert the tripped end of each five wires into the appropriate hole in the female insert, and then tight each screw (to tight each wire in place).

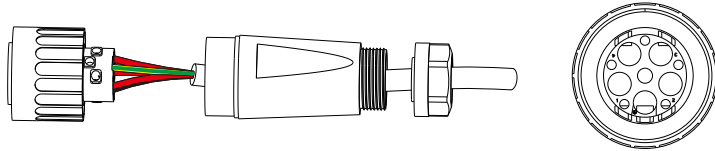

NO.of holes		1	2	3	4
Wire type	PE	N	R	S	T

8. Tight the cable
- Slide the back shell towards the female insert.
 - Hold the middle part of the female insert, rotate the back shell to connect it to the female insert and tight it.
 - Slide the cable nut towards the back shell.
 - Rotate the cable nut to secure the cable.

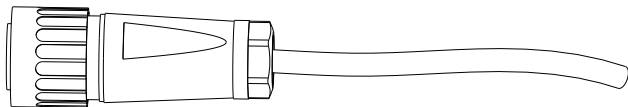

9. Connect the AC plug to the inverter, and then rotate the locking ring of the female insert to screw the plug to the inverter.

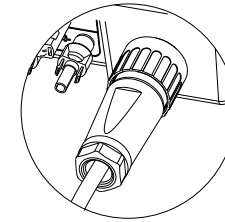

Selection of Fuses and Cables

Mains cable (AC line cable) shall be short circuit protected and thermal overload protected.

Always fit the input cable with fuse. Normal gG(US:CC or T) fuses will protect the input cable in short circuit situation. They will also prevent damage to adjoining equipment.

Dimension the fuses according to local safety regulations, appropriate input voltage and the related current of the solar inverter.

AC output protected by external fuse (gG rated current 25A/250VAC for 10KW and 12KW; 32A/250VAC for 15KW, 17KW and 20KW) provide in all live connections to the AC supply.

The rated short circuit breaking capacity of the above protective device shall be at least equal to the prospective fault current at the point of installation. See section technical data of this manual for details.

Ac output cable: Cu, L, N+PE, 2*6.0+6.0mm² @40°C ambient with a max length of 5m, with operating time of the fuse is less than 5 seconds, installation method B2 according to EN60204-1:2006, annex D: cable in conduit cable trunking system, number of loaded circuit only one. Use H07RNF (cord designation 60245 IEC66) for an ambient temperature of 40 °C or less and use 90°C wire for ambient temperature between 40°C and 60°C.

Note1: For conditions differing from those mentioned above, dimension the cables according to local safety regulations, appropriate input voltage and the load and the load current of the unit. (You can choose a thicker cable but the fuses must be rated according to the cable.)

Note2: Fuses must be approved by Notified Body.

Inverter is not provided galvanic isolation from the mains to the PV array, backfeed current to the array is 25A/250VAC for 10KW and 12KW; 32A/250VAC for 15KW, 17KW and 20KW based on the fuse provided in the mains. Also in the worst case, the reverse current comprises the sum of the short-circuit currents of all intact lines.

Therefore the current-carrying capacity of the components and sub-assemblies provided in the end-use system (connectors, cables, junction box, switch gear, etc.) and the reverse current PV module shall be considered based on the backfeed

current and reverse current. The direct current (DC) circuit breaker or fuse between each solar generator and inverter shall be provided based on solar inverter input ratings.

Select DC cables based on the above inverter back-feed current and I_{sc} PV rating and V_{max} ratings.

NOTE!
 If the AC cable you choose is 16mm or larger, you need to break the connection between the two rubber rings which make up the rubber insert as below.



• Communication interface

This product has a series communication interfaces: such as RS485/RS232, Dry contact. Operating information like output voltage, current, frequency, fault information, etc., can be delivered to PC or other monitoring equipment via these interfaces.

① RS232 communication

RS 232 is one standard communication interface. It transmits the data between PC and one single ZDNY inverter. Thus this method is generally used for software updating and serviceman's testing. There are two RS232 connectors on the inverter. The left one is used for updating the main DSP and subsidiary DSP. The definition is as below.

PIN	PIN1	PIN2	PIN3	PIN4	PIN5	PIN6	PIN7	PIN8	PIN9
Function	NC	TX	RX	NC	RND	NC	NC	NC	NC

You can select which DSP need to be updated by the DIP switch on the right side of the RS232 connector.

DIP switch No.(left to right)	1	2	Status
The position of the DIP switch	up	up	Can not update
	up	down	Main DSP update
	down	X	Subsidiary DSP update

• Connection Step:

1. Open the communication lid with a screwdriver.

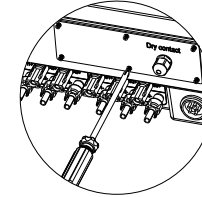

2. Connect one side of the RS232 line to the inverter, the other side to the computer.

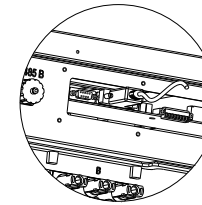

3. Update the software on the computer.

4. After the update is finished, disconnect the RS232 line, and install the communication lid.

② RS 485 communication

RS 485 is generally for multi inverters' communication. Up to 32 inverters could communicate at the same time, but wire length should be $\leq 1200m$. System monitor Sunny Logger should be configured to realize one PC communicates with multi inverters at the same time. Through PC Sunny Logger could get real time PV plants operating data. RS 485 connection use the RJ45 connector, RJ 45 PIN definition is as below.



PIN	PIN1	PIN2	PIN3	PIN4	PIN5	PIN6	PIN7	PIN8
Function	NC	NC	NC	A	B	NC	NC	NC

• Connection Step:

1: Separate the RS 485 sealing connector.

2: Insert the communication line into these parts following the below order.

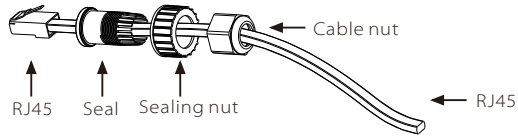

- 3: Strip the insulation from the communication cable ends.
- 4: Insert the communication cable into the RJ45 connector following the PIN definition rule.
- 5: Crimp the RJ45 connector with the crimping plier.

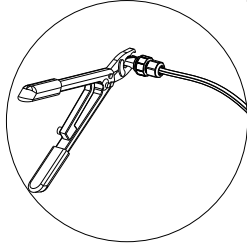

- 6: Tight the communication connector.
 - a. Slide the seal towards the RJ45 connector, fix the seal and the connector.
 - b. Slide the sealing nut towards the seal.
 - c. Slide the cable nut towards the seal, rotate the cable nut to secure the connector.



- 7: Twist off the RS 485 screw cap on the inverter.
- 8: Insert the RJ45 connector and rotate the sealing nut to connect the connector and the inverter tightly.

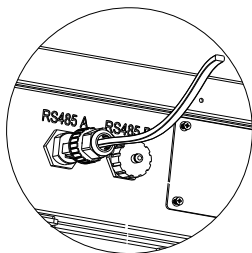

③ Dry contact

Dry contact is provided to give a remote monitor and remote control with the optional accessory. The remote monitor function provides an indication on the inverter's working status. The remote control function provides a contact signal to operate the inverter. The dry contact communication use terminal blocks. The PIN definitions and the circuit connection are as below.

PIN	PIN1	PIN2	PIN3	PIN4	PIN5	PIN6	PIN7	PIN8
Definition	Remote control for reactive power regulation						Remote monitor	

Note: The external connection of PIN7 and PIN 8 must within the range of 300V 2A.

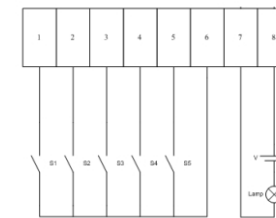

●Connection Step:

1: Open the communication lid on the back of the inverter.

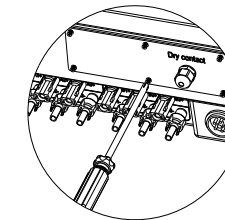

2: Separate the dry connect cable gland.

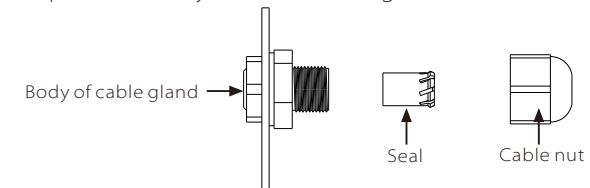

- 3: Choose at least 16mm² wire, strip the insulation from the wire ends.
- 4: Insert the wire into the separate parts as following.

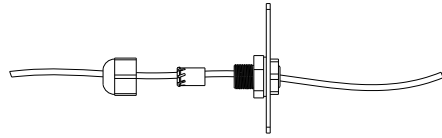

- 4: Insert the tripped wire into the hole of the terminal block.
- 5: Screw down the screws on the terminal block.

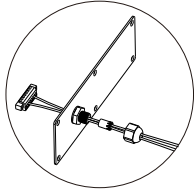

- 6: Connect the terminal block.
 - a. Insert the male terminal into the female terminal on the inverter.
 - b. Screw down the two screws on the both side of the terminal block.

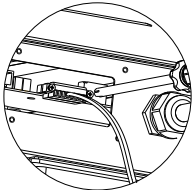

- 7: Install the communication lid.
- 8: Tight the connection of the cable gland.
 - a. Slide the seal to the body of the cable gland, insert the seal into the body of the cable gland.
 - b. Slide the cable nut to the body of the cable gland, rotate the cable nut to tight the connection.

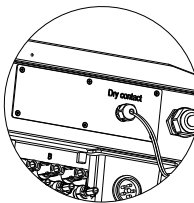

5.7 Run the inverter

Start inverter after checking all below steps:

- Check that the device is fixed well on the wall.
- Make sure all the DC wirings and the AC wirings are completed.
- DC connectors which are not used should be sealed by cover.
- Turn on the external AC and DC connector.
- Turn on the DC switch to the "ON" position.

Start inverter

- Inverter will start automatically when PV panels generate enough energy.
- Check the status of LED and LCD screen, the LED should be green and the LCD screen should display the main interface.
- If the LED is not green, please check the below:
 - All the connections are right.
 - All the external disconnect switches are closed.
 - The DC switch of the inverter is in the "ON" position.



WARNING !

Power to the unit must be turned on only after installation work has been completed. All electrical connections must be carried out by qualified personnel in accordance with legislation in force in the country concerned.



NOTE !

Please set the inverter if it is the first time to start up. Above steps is for the regular start up of the inverter. If it is the first time to start up the inverter, you need to setup the inverter ..

6 Operation Method

6.1 Control panel

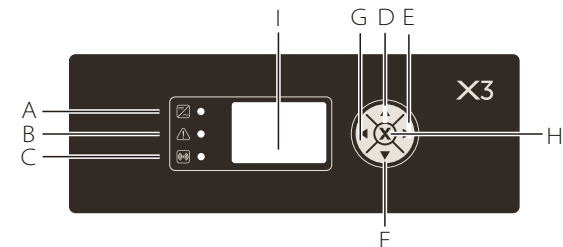

Object	Name	Description
A	Indicator LED	Green LED:The inverter is in normal state.
B		Red LED:The inverter is in fault state.
C		Yellow LED:The inverter is in communication.
D	Function button	Up button:Move cursor to up side or increase values.
E		Right button:Move cursor to right side.
F		Down button:Move cursor to down side or decrease values.
G		Left button:Move cursor to left side.
H		OK:Confirm the selection.
I	LCD Screen	Display the information of the inverter in this LCD screen.

6.2 LCD Function

Menu structure

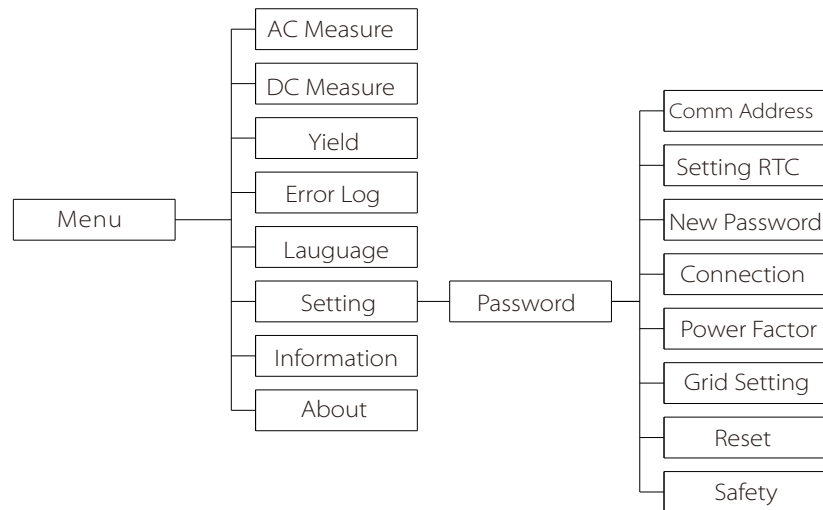

6.3 LCD Operation

• LCD Graphic Display(Main interface)

The main interface is the default interface,the inverter will automatically jump

to this interface when the system started up successfully and not operated for a period of time.

The information of the interface is introduced as below:

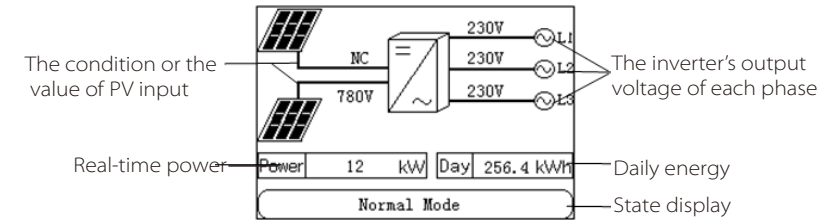

• Menu interface

The menu interface is a transfer interface for the user to get into the other interface to finish the setting or get information.

-User can get into this interface by press the "OK" button when the LCD displays the main interface.

-User can select interface by moving the cursor with the function button, and press "OK" confirm the selection.

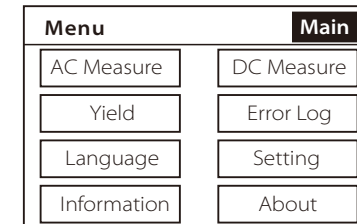

•AC Measure and DC Measure

AC measure and DC measure are display interfaces to show the information of DC input and AC output.

-User can get into the two interfaces by select the "AC Measure" or "DC Measure" with cursor on the menu interface and press "OK" to confirm.

-Move the cursor to "Back" and press "OK" to get back to the menu interface.

AC Measure		Back
VacR = 230.0V	IacR = 1.8A	
VacS = 230.0V	IacS = 1.8A	
VacT = 230.0V	IacT = 1.8A	
PacR = 424.3V	PacS = 424.3V	
PacT = 424.3V	Fac = 50Hz	

DC Measure		Back
Vdc1 = 0.0V	Vdc2 = 780.3V	
Idc1 = 0.0A	Idc2 = 1.8A	
Pdc1 = 0.0W	Pdc2 = 1273W	

•Yield

Yield interface display the generated power with histogram.
 -User can get into the interface by select the“Yield” with cursor on the menu interface and press“OK” to confirm.
 -The X-axis can be switched with Day or Hour by press left and right button.
 -The Y-axis display the total generated power.
 -Move the cursor to“Back”and press“OK”to get back to the menu interface.

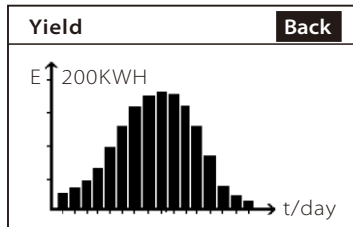

•Error log

Error log interface displays the error information happened with the inverter.
 It can record at most 5 items.
 -Enter the error log interface by select the“Error Log” with cursor on the menu interface and press“OK” to confirm.
 -It can display 3 items,press up and down button to see more error items.
 -Move the cursor to“Back”and press“OK”to get back to the menu interface.

Error Log	Back
1:2012-02-24 13:23:24 Grid Lost Fault	
2:2012-03-24 14:14:24 SW_FANIFault	
3:2012-04-24 13:11:24 SW OCP DCI	

•Setting

User can get the safety,time,password and connection etc. with this function.
 -Enter the“Setting”by select the“Setting” with cursor on the menu interface and press“Ok”to confirm.
 -The pass word interface will appears for the user to enter the password.
 -Enter the password,confirm with“OK”.
Note:The default password is“1234” for the first time to enter.

Password	OK	Back
0 0 0 0		

If the password is correct it will jump into the setting interface or it will return back to the menu interface.

Setting	Back
Comm Address	Setting RTC
New Password	Connection
Power Factor	Grid Setting
Reset	Safety

A)Comm Address

-The user can setting the comm address here.
 -Press up or down to increase or decrease the value.
 -Press OK to confirm.

Comm Address	OK	Back
0 0 0		

B)Setting RTC

Setting RTC is used to set the current system time.
 -Enter the“Setting RTC” by select the“Setting RTC” with cursor on the setting interface and press“OK” to confirm.
 -Alternate the cursor by press function button,when the cursor is on the item

- you want to change. Press "OK" to confirm.
- Press up and down button to increase or decrease the number.
- Alternate the cursor to "OK:" on the top of the screen and press "OK" to confirm the setting, or alternate cursor to "back" and press "OK" to cancel the setting. The screen will jump to the setting interface after that.

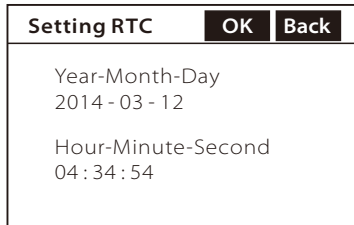

C) New Password

- User can set user's password to protect the inverter system from being changed.
- Enter the "New Password" by select the "New Password" with the cursor on the setting interface press "Ok" to confirm.
- Enter the new password. Alternate the cursor by press function button, when the cursor is on the item you want to change. Press "Ok" confirm.
- Press up and down button to increase or decrease the number.
- Enter the same password again in the below blank.
- Alternate the cursor to "Ok" on the top of the screen and press "OK" to confirm the setting, or alternate cursor to "back" and press "OK" to cancel the setting. The screen will jump to the setting interface after that.

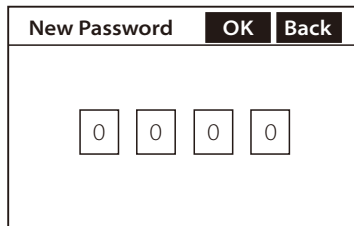

D) Connection

- Connection setting is used for changing the connection type of DC input.
- Enter the "Connection" by select the "Connection" with cursor on the setting interface and press "OK" to confirm.
- Alternate the cursor by press up and down button, when the cursor is on the item you want to choose. Press "OK" to confirm.
- Alternate the cursor to "Ok" on the top of the screen and press "OK" to confirm the setting, or alternate cursor to "back" and press "OK" to cancel the setting. The screen will jump to the setting interface after that.

- Comm-String: 2MPP trackers are connected together.
- Mul-String: 2 MPP trackers are independent.

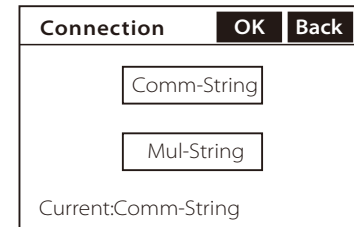

E) Power Factor

- Power factor setting is to set the power factor of the inverter, it contains four mode: "off mode", "constant cosφ mode", "cosφ mode" and "power limit mode".
- Enter the "Power Factor" by select the "Power Factor" with cursor on the setting interface and press "OK" to confirm.
- Enter the power factor interface, move the cursor to the mode, press up and down button to choose the right mode you want to set, and press the OK button to confirm.
- Once you have choose the right mode, press the up and down button to select the right parameter you want to set, press the OK button to confirm. The cursor will flash, that you can set the parameter by press up and down button to increase or decrease the value. Press the OK button to confirm your set.
- Enter the power limit mode, the value means the limitation of the output power, 1.00 means 100 percent output power, 0.85 means 85 percent output power.
- Once the setting is finished, move the cursor to OK on the screen, confirm the setting by pressing the OK button.

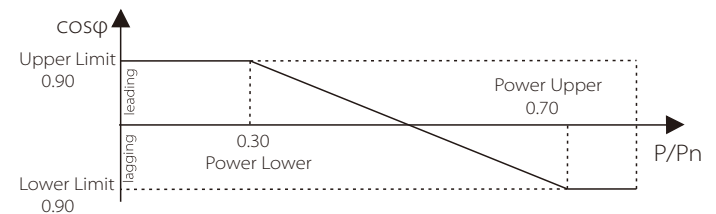
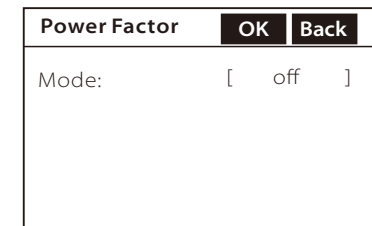
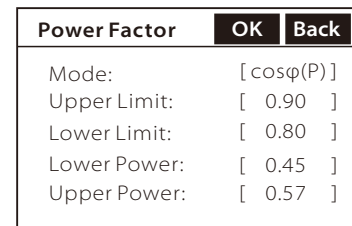

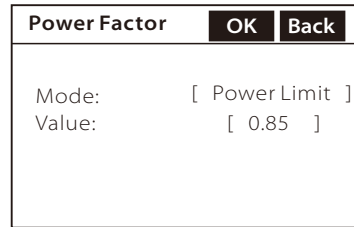
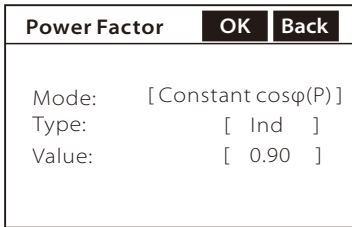

F)Grid Setting

Grid setting is to set the limited parameter of the public grid.It has 8 parameters to set.

- Enter the "Grid Setting"by select the "Grid Setting"with cursor on the setting interface and press "OK"to confirm.
- Enter the "Grid Setting"interface.Move the cursor to the parameter you want to set by press up and down button.Confirm the select by pressing 'OK'.
- The cursor will flash,press the up and down button to increase or decrease the value and press "Ok"to confirm.
- Press the down button when the cursor is at the bottom of the screen,the screen will jump to the next page.

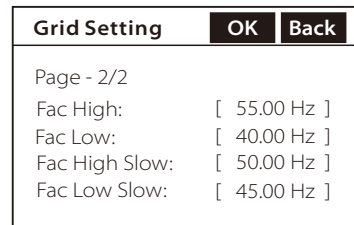
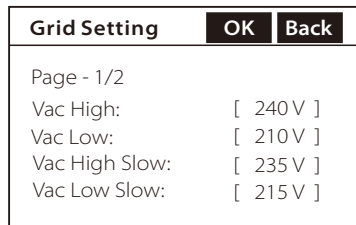

G)Reset

Reset function can reset E-today and error log.

- Enter the interface by selecting the "Reset"with the cursor on the setting interface and press"OK"to confirm.
- Select "Reset E-today"or "Reset error log"and press"OK"to confirm.
- After get into Reset E- today or reset error log interface.Press OK to reset.

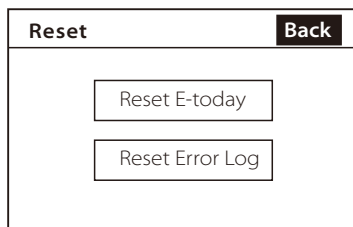

H)Safety

Safety can set the different countries'safety rule here.

- Enter the safety by select the "Safety"on the setting interface.
- Press up and down to choose the different country,press"OK"to confirm.
- Move the cursor to "Back"and press OK to get back to the setting interface.

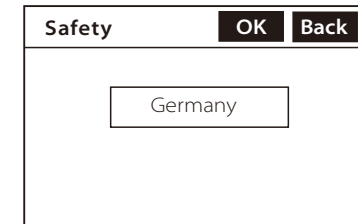

• Information

Information interface display the main information about inverter.Such as the Total generated power.The current temperature inside the inverter and the total run time.

- Enter the "Information"by selecting the "Information"with cursor on the menu interface and press"OK"to confirm.
- Move the cursor to 'Back"and press OK to get back to the menu interface.

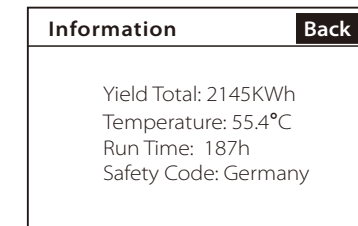

• About

About interface display the version No, and the series No, of the inverter.

- Enter th "About" by selecting the "About"with cursor on the menu interface and press"OK"to confirm.
- Move the cursor to"Back"and press"OK"to get back to the menu interface.

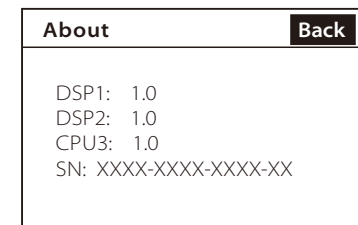

7 Troubleshooting

7.1 Trouble Shooting

This section contains information and procedures for solving possible problems with the ZDNY series inverters, and provides you with trouble shooting tips to identify and solve most problems that could occur with the ZDNY series inverters.

This section will help you narrow down the source of any problem you may encounter. Please read the following troubleshooting steps.

- Check the warning or fault messages on the System Control Panel or Fault codes on the inverter information panel. If a message is displayed, record it before doing anything further.
- Attempt the solution indicated in below table.

Faults	Diagnosis and Solution
SPI ERR	SPI communication fault <ul style="list-style-type: none"> • Disconnect PV+ and PV-, reconnect them. • Or seek help from us, if can not go back to normal state.
SCI ERR	SCI communication fault <ul style="list-style-type: none"> • Disconnect PV+ and PV-, reconnect them. • Or seek help from us, if can not go back to normal state.
Lcd CommsErr	LCD communication fault <ul style="list-style-type: none"> • Disconnect PV+ and PV-, reconnect them. • Or seek help from us, if can not go back to normal state.
HW_OCP_ACR	AC over current detected by hardware. <ul style="list-style-type: none"> • Disconnect PV+ and PV-, reconnect them. • Or seek help from us, if can not go back to normal state.
HW_OCP_ACS	
HW_OCP_ACT	
HW_OVP_BUS	BUS over voltage detected by hardware. <ul style="list-style-type: none"> • Disconnect PV+ and PV-, reconnect them. • Or seek help from us, if can not go back to normal state.
HW_OCP_Boost I	Boost over current detected by hardware. <ul style="list-style-type: none"> • Disconnect PV+ and PV-, reconnect them. • Or seek help from us, if can not go back to normal state.
HW_OCP_Boost II	
PV ConfigSet_Wrong	PV connection fault. <ul style="list-style-type: none"> • Disconnect PV+ and PV-, reconnect them. • Or seek help from us, if can not go back to normal state.

Faults	Diagnosis and solution
SampleConsistentFault	The detection circuit fault. <ul style="list-style-type: none"> • Disconnect PV+ and PV-, reconnect them. • Or seek help from us, if can not go back to normal state.
UnRecover_Relay Fault	Relay fault. <ul style="list-style-type: none"> • Disconnect PV+ and PV-, reconnect them. • Or seek help from us, if can not go back to normal state.
Current_Sensor_Fault	Current sensor fault. <ul style="list-style-type: none"> • Disconnect PV+ and PV-, reconnect them. • Or seek help from us, if can not go back to normal state.
UnRecover_FANXFault	Fan circuit fault. <ul style="list-style-type: none"> • Disconnect PV+ and PV-, reconnect them. • Or seek help from us, if can not go back to normal state.
EEPROM_WR_Fault	EEPROM reading or writing fault. <ul style="list-style-type: none"> • Disconnect PV+ and PV-, reconnect them. • Or seek help from us, if can not go back to normal state.
GFCI_Device_Fault	Leakage current detection device Fault. <ul style="list-style-type: none"> • Disconnect PV+ and PV-, reconnect them. • Or seek help from us, if can not go back to normal state.
SW_OCP_ACR	AC over current detection by software. <ul style="list-style-type: none"> • The grid current is not stable. • Wait for a while,the system will reconnet to the grid automatically.
SW_OCP_ACS	
SW_OCP_ACT	
SW_OCP_Boost I	Boost over current detection by software. <ul style="list-style-type: none"> • The PV input is not stable. • Wait for a while,the system will reconnet to the grid automatically.
SW_OCP_Boost II	
PLL Fault	Phase-lock over time. <ul style="list-style-type: none"> • Wait for a while,the system will reconnet to the grid automatically. • If this fault happens frequently,Please check the three phase connection. • Or, seek help from us.
Grid_Lost_Fault	Grid voltage or frequency is out of range or not present at all. <ul style="list-style-type: none"> • System will reconnect after the utility is back to normal. • Or seek help from us,
SW_OVP_AC	Over voltage in AC side. <ul style="list-style-type: none"> • Wait for a while,the system will reconnet to the grid automatically. • Or seek help from us,

Faults	Diagnosis and solution
SW_OVP_Boost I	Boost over voltage detected by software. • Check the PV input,make sure the Max.DC voltage is < 950V. • Or seek help from us.
SW_OVP_Boost II	
SW_OVP_Boost	
SW_OVP_ACR	Over current/voltage of each phase in AC side detected by software. • If one of the fault happens frequently,please contact with the dealer to check the nearest transformer. • Or seek help from us.
SW_OVP_ACS	
SW_OVP_ACT	
SW_UVP_ACR	
SW_UVP_ACS	
SW_UVP_ACT	
SW_OVP_BUS	Bus over voltage detected by software. • Check the PV input,make sure the Max.DC voltage is < 950V. • Or seek help from us.
SW_OFFP_AC	The grid frequency is out of limit. • If this happens frequently,please contact with the grid Corp, get the password to set the value.(VDE4105) • Or seek help from us.
SW_UFP_AC	
SW_UFP_ACR	
SW_UFP_ACS	
SW_UFP_ACT	
SW_OFFP_ACR	
SW_OFFP_ACS	
SW_OFFP_ACT	
Iso I Fault	Isolation fault in boost circuit. • Please check the PV input wire. • Or seek help from us,
Iso II Fault	
RelayShortFault	The relay in the inverter is fault. • Please contact with us.
RelayOpenFault	
SW_OCP_DCI	DCI current over limit. • Please contact with us.

Faults	Diagnosis and solution
SW_OCP_RCD	Residual current detector device fault or residual current over limit, • Check the impedance of DC input and AC output. • Or seek help from us.
SW_OCP_RCD_Jump I	
SW_OCP_RCD_Jump II	
SW_OCP_RCD_Jump III	
SW_OCP_RCD_300mA	
SW_OVP_ACRMS	The RMS value of AC current is over limit. • If this happens frequently,please contact with us.
SW_OverTemp	Temperature is over limit. • Check if fan is running normally. • Check if the environment temperature is over limit. • Or seek help from us.
SW_IACRMS_Unbalance	The RMS value of AC current not balance.
SW_FAN I fault	Fan fault. • Check if fan is running normally. • Check if anything block the fan. • Or seek help from us.
SW_FAN II fault	
SW_FAN III fault	
UnRecover_LN_Fault	The L and N line is not correctly connected. • Check the connection of L and N. • Or seek help from us.
Auto_Test_Fault	Auto test failed.(For Italy)
SW_BUS_Unbalance	Bus not balance. • Contact with us if this happens frequently.
PhaseDelta Fault	Phase fault. • Contact with us if this happens frequently.
Control Loop ERR	Controller fault. • Contact with us if this happens frequently.

If your inverter's information panel is not displaying a Fault light, check the following list to make sure that the present state of the installation allows proper operation of the unit.

- Is the inverter located in a clean, dry, and adequately ventilated place?
- Have the DC input breakers been opened?
- Are the cables adequately sized and short enough?
- Are the input and output connections and wiring in good condition?
- Are the configurations settings correct for your particular installation?
- Are the display panel and the communications cable properly connected and undamaged?

Contact SolaX Customer Service for further assistance. Please be prepared to describe details of your system installation and provide the model and serial number of the unit.

7.2 Routine Maintenance

Inverters do not need any maintenance or correction in most condition, but if the inverter often loses power due to overheating, this can be the following reason:

- The cooling fins on the rear of house are covered by dirt.

Only trained and authorized professional personnel who are familiar with the requirements of safety was allowed to perform servicing and maintenance work.

• Safety checks

Safety checks should be performed at least every 12 months by manufacturer's qualified person who has adequate training, knowledge, and practical experience to perform these tests. The data should be recorded in an equipment log. If the device is not functioning properly or fails any of test, the device has to be repaired. For safety check details, refer to this manual, section 2 Safety instruction and EC Directives.

• Maintain periodically

Only qualified person may perform the following works.

During the process of using the inverter, the manager shall examine and maintain the machine regularly. The concrete operations are follow.

- 1: Check that if the inlet and outlet of the inverter are blocked, if the fans work normally, the machine can be cleaned and absorbed dust when necessary. This work shall be check time to time.
- 2: Check that if the indicators of the inverter are in normal state, check if the keys of the inverter are in normal state, check if the display of the inverter is

normal. This check should be performed at least every 6 months.

- 3: Check that if the input and output wires are damaged or aged. This check should be performed at least every 6 months.
- 4: You should get the inverter panels cleaned and their security checked at least every 6 months.

Clean the ventilation grids

The inverter takes cooling air in from the grid and below it out again through the grid with the fan. If the ventilation grid is covered with dust will directly result in bad flow of air to the inverter. Clean the ventilation grids if they are dirty.



NOTE !

"The ventilation grids can not be removed for long. Since the ventilation grids takes the responsibility to protect the inverter against the entrance of insects.

8 Decommissioning

8.1 Dismantling the Inverter

- Disconnect the inverter from DC Input and AC output.
- Remove all connection cables from the inverter.
- Open the anti-theft lock.
- Remove the inverter from the bracket.
- Remove the bracket if necessary.

8.2 Packaging

If possible, please pack the inverter with the original packaging. If it is no longer available, you can also use an equivalent carton that meets the following requirements.

- Suitable for loads more than 50kg.
- With handle.
- Can be fully closed.

8.3 Storage

Store the inverter in dry place where ambient temperatures are always between -20 °C - +60 °C.

8.4 Disposal

When the inverter or other related components need to be disposed. Have it carried out according to local waste handling regulations. Please be sure to deliver wasted inverters and packing materials to certain site, where can assist relevant department to dispose and recycle.

- **The inverter is suitable for below countries**

State	Voltage and Frequency range
Germany	Comply with the local grid
France	Comply with the local grid
Norway	Comply with the local grid
Denmark	Comply with the local grid
Netherland	Comply with the local grid
Czech	The reconnection time can be adjust from 20s to 20min.
Slovenia	Comply with the local grid
Greece(continent)	Comply with the local grid
Greece(island)	Comply with the local grid
England	Comply with the local grid
Australia	Comply with the local grid
Belgium	Comply with the local grid

For Czech Republic there must be the possibility to adjust the reconnection time to 20 minutes. Please provide an extract of the manual in the report, showing that this requirement is fulfilled.