



# SELECTRONIC



## Instruction Manual for SP LINK

Configuration and monitoring for  
SP PRO AU and GO series

# Contents



<b>Contents</b>	<b>2</b>	Input and Output Settings	53
Using This Manual	3	Shunts Settings	58
Overview	4	Expansion Card Wiring Diagram	59
<b>Using SP LINK</b>	<b>4</b>	Save and Configure Settings	59
System Requirements for SP LINK	5	<b>Performance Monitoring</b>	<b>60</b>
Firmware Version	5	Customer Interface	61
Glossary of Terms	5	Integrator / User Interface	61
Getting Started with SP LINK	6	Quick View	62
HELP!	6	Data View	64
SP LINK Easy Start Guide	7	Now Tab	64
Site Configuration Wizard	8	STATUS	64
Select Battery Configuration	8	DC	65
Source of Renewables	9	AC Source	65
Select Unit Application	9	Inverter AC	65
Summary of Settings	9	System regulation status	66
Entering extra Details and Saving	9	Today Tab	67
Sending Configuration to the Inverter	9	DC totals	67
Advanced Configuration	10	AC totals	67
Firmware Update (Easy Start Guide)	10	DC Peak	67
Preparing a new site	11	AC coupled SOLAR	67
Saving a new site	12	DC History Tab	68
Manually Preparing a new configuration	13	AC History Tab	71
Saving a new configuration	15	Technical Data Tab	73
Connecting to the SP PRO	15	Inverter Details Tab	76
Connection status bar	16	Battery Management Tab	77
Configuring the SP PRO	17	Expansion Card Wiring Diagram Tab	78
Connection Settings	18	<b>Service Settings</b>	<b>80</b>
Customising SP LINK to suit the site	20	Time and date	81
Performance Data Retrieval	21	Battery SoC	81
Performance Data Viewer	22	Expansion Card	81
Firmware Update	23	Settings Passcode	81
<b>Configuration Settings</b>	<b>27</b>	Zero Shunts	82
Quick Start	28	Fan Type	82
Inverter Settings	29	AC Safety Monitor	82
Battery Settings	31	Request Battery Equalise	83
Charger Settings	33	Login Password	83
AC Source Settings	36	AC Solar Link Test	83
AC Input	36	Setting Charge Efficiency Index	83
Generator Auto Start	38	Setting For Poor Grid Quality	83
Generator Schedule Start	42	Schedule Restart	84
Generator Control Settings	45	Installer Only Service Settings	84
Solar Hybrid Control Settings	47	<b>Appendix One Alert Messages</b>	<b>86</b>
System Settings	50		



## Using This Manual

While every attempt has been made to ensure this manual is as self explanatory and clear as possible, there are some technical issues and safety warnings that require thorough understanding. It is extremely important that you and your integrator/installer follow all of the instructions set out in this document; failure to do so may void the warranty and stop you from gaining the full benefits that we know this product can provide.

A PDF copy of this manual may be downloaded from the Selectronic web site [www.selectronic.com.au](http://www.selectronic.com.au) and is also included within the Help menu of the SP LINK software.

You will notice that throughout the manual these symbols will be repeated. These symbols are very important.



This symbol indicates danger. Failure to observe this warning may result in serious injury or death, loss of property or damage to the power system.



This symbol is used to draw attention towards information that will assist you in making full use of the system or gives notice to information which may not seem immediately apparent.

# Using SP LINK



## Overview

“SP LINK is the pathway to the real power of the SP PRO AU and GO”

SP PRO AU and GO series of inverters are really many products in one. SP LINK provides a simple and easy way to configure your SP PRO to suit your particular installation.

Install SP LINK software (on the supplied USB stick or download from [www.selectronic.com.au](http://www.selectronic.com.au)) onto a PC computer. We suggest these steps are done before heading to the installation site.

Once on site simply unpack the unit, mount it on a wall, connect the appropriate cables then use the Wizard in SP LINK to configure the SP PRO – and you’ve got power.



As a safeguard, the SP PRO AU and GO inverters will not start until they have been configured using SP LINK.

## System Requirements for SP LINK

The system requirements include:

### PERFORMANCE REQUIREMENTS:

- Microsoft Windows XP SP3, Vista SP1, 7, 8, 8.1, 10  
Other operating systems not supported.
- 30 MB hard disk space
- If Microsoft .NET 4.0 Framework is not already installed then approx. 850 MB of additional disk space will be required.
- Adobe Reader - 100 MB hard disk space
- 1 GHz Pentium or faster processor.
- 512 MB RAM
- USB Port

### PERFORMANCE VIEWER REQUIREMENTS

Microsoft Excel 2003 or higher.  
Office 365 not supported.

## Firmware Version

This SP LINK manual details configuration parameters and options found in the included version of SP PRO series firmware. Some parameters are no longer supported and are not detailed within this manual. Please refer to prior SP LINK manual for details of unsupported features.

SP LINK is fully backward compatible with all prior versions of SP PRO series firmware.

## Glossary of Terms

Terms used within this manual

DC Coupled system	Refers to when the Solar is connected to the DC side of the inverter system through a Solar Controller.
AC Coupled system	Refers to when the Solar is connected to AC Side of the inverter system via a separate Grid Tie inverter.
Solar Hybrid	Refers to a system which is connected to the electricity grid and also utilises batteries in the system.
AC Source	The primary AC input that is connected to the SP PRO, e.g., Grid, Auto start Generator, Shore Power.
Site File	An SP LINK file which is set up for a particular site that you will need to connect to.
Configuration File	Effectively a subset of a Site File which contains all of the settings that you want to load into the SP PRO
Solar Array	A collection of Solar Panels.
PV	Photo voltaic solar power .
Sealed Battery	A lead acid battery with no access to the electrolyte - either valve regulated or gel. No hydrogen gas discharge during normal operation.
Flooded Battery	A lead acid battery with access caps for maintaining the electrolyte - replacing water lost during recharge operations. Hydrogen gas discharged during normal recharge operation.
Lithium Battery	A battery based around lithium technology. An example is Lithium Iron Phosphate (LiFePO4)
Aquious Battery	A battery with salt electrolyte such as the Aquion brand of battery.
State of Charge	(SoC) is the amount of charge in the battery bank expressed as a % of the battery capacity. When SoC = 100% the battery is fully charged. When the SoC is 50% then the battery is half charged.

## Getting Started with SP LINK

You will find SP LINK and other helpful documents contained on the USB stick supplied with the SP PRO, it is good practise to check at [www.selectronic.com.au](http://www.selectronic.com.au) for the latest version of SP LINK.

After loading SP LINK onto the computer, you can now begin to use SP LINK. However, we do warn that to achieve the best performance from the system, configuration should be done by an experienced system designer. For maximum warranty in Australia, you will need to employ the services of a Selectronic Accredited Integrator. For full warranty terms and conditions please see the warranty supplied with the SP PRO inverter.

To get started, you do not have to be connected to an SP PRO inverter. Once you have loaded SP LINK onto the computer, you can pre-configure and store on the computer the site information and configuration settings. These are then ready to transfer into the SP PRO inverter after it is installed.



When you first open SP LINK, the Splash screen will appear. Once SP LINK has loaded, the screen will disappear and the “How to Access Help” screen will appear.

## HELP!



When working with SP LINK simply RIGHT CLICK MOST HEADINGS and tabs and a help panel will appear on the right side of the screen.

You will see the How to Access this Help guide each time you start SP LINK

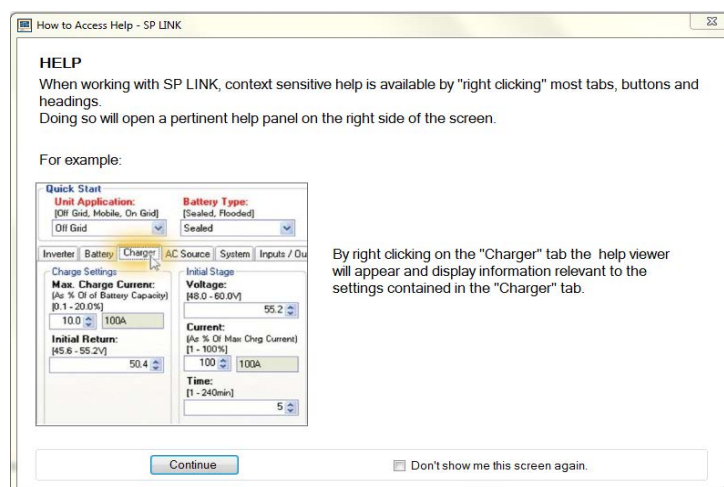

By clicking “Continue” SP LINK Easy Start Guide will start. By clicking the tick box “Don’t show me this screen again” will prevent this from being displayed in the future.

You can also access both the SP PRO manual and SP LINK manual (this document) from the Help menu at any time.

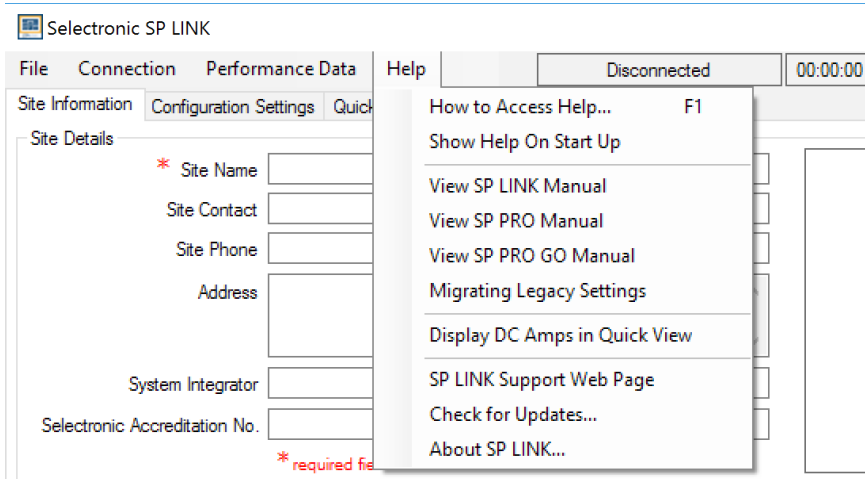

## SP LINK Easy Start Guide

The Easy Start Guide provides a quick means of performing the most common tasks in SP LINK. Simply choose one of the three options or select from Recent Sites to open the saved information on an already configured SP PRO

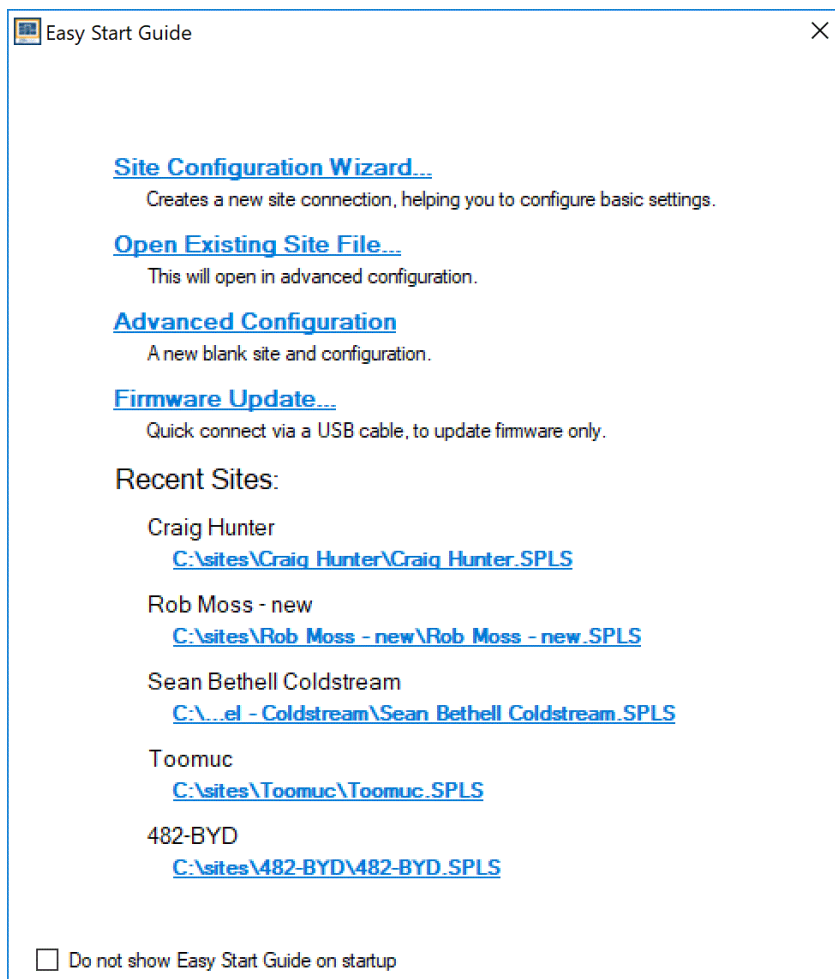

This window appears every time SP LINK is started and can also be accessed at any time via the “File / Site Information / New (Easy Start Guide)” menu (or Ctrl N short cut).

## Site Configuration Wizard

Provides a quick and easy way to configure a SP PRO in a new installation. The configuration information can be created and saved to a Site file ready for sending to the inverter as required.

The wizard steps through the configuration process and informs the system designer at each step of any invalid configuration or limitations of the chosen components.

The wizard is self explanatory. A description of each screen is given below

### New Site Configuration Details

Enter a unique and descriptive name for the site where the SP PRO is installed. This name will be used to store and retrieve the information at a later date.

**Select a Detected USB Device:** If the computer USB port is plugged into a SP PRO that is powered up then its model number and serial number will be displayed. Select the inverter to configure

**Manual Configuration :** If there is no SP PRO connected then click on either the SP PRO AU or SP PRO GO image then select model number.

### Select Battery Configuration

**Standard Battery Configurations and myGrid Kits** offers choices of myGrid kits and other specific battery configurations, such as LG Chem.

Otherwise select **Custom Battery Configuration** to manually enter the battery information. If the system is a batteryless configuration then select No Battery Installed (this option is only valid for SP PRO GO models and requires an optional Batteryless kit.)

Once the battery type is chosen the battery State of Charge levels are chosen (except for No Battery option).

**SoC Support Limit** (Support Capacity) sets the energy that is available for normal daily operation. If the system is Off Grid with an auto start generator, then this is the SoC level at which the generator will start This value is dependant on the battery type and its expected cycle life.

**Inverter Shutdown SoC** (Minimum Backup Capacity) sets the energy available during either a grid outage (for Solar Hybrid) or when the generator fails to start (for off grid)



## Source of Renewables

Select the configuration of the Solar or other renewable energy sources in the system. The wizard will provide information on the power limits of any energy source as they are selected.

Where **Managed AC Coupled Solar** is selected, the make of the Selectronic Certified grid inverter is then selected. Whilst the SP PRO is connected to grid power, the maximum allowable Managed AC coupled solar power is only limited by the selected SP PRO model. When the SP PRO is running Islanded (either the grid has failed or the system is an Off Grid system), the SP PRO will limit the maximum solar power that can be produced by the Selectronic Certified grid inverters. This limit which is determined by the system battery capacity as displayed on the screen.

If the energy source is **DC coupled** (that is fed into the battery via a DC charge regulator or DC MPPT) then an external DC current shunt must be installed.



## Select Unit Application

The first three options are for grid connected systems and are applicable to both the SP PRO AU and GO series. The **Off Grid** Option is only applicable to the SP PRO AU.

When **Self-Consumption of Renewables** is chosen the system will do a full recharge once per week. Its time can be changed to coincide with the period of lowest tariff and at a time when the renewable would have performed a full charge when available.

## Summary of Settings

The next screen gives a summary of all the settings entered to allow a final check before the configuration is created. Clicking Finish will complete the wizard, update the configuration settings in SP LINK and return to the Site Information and Connections Settings screen in Advance Configuration.

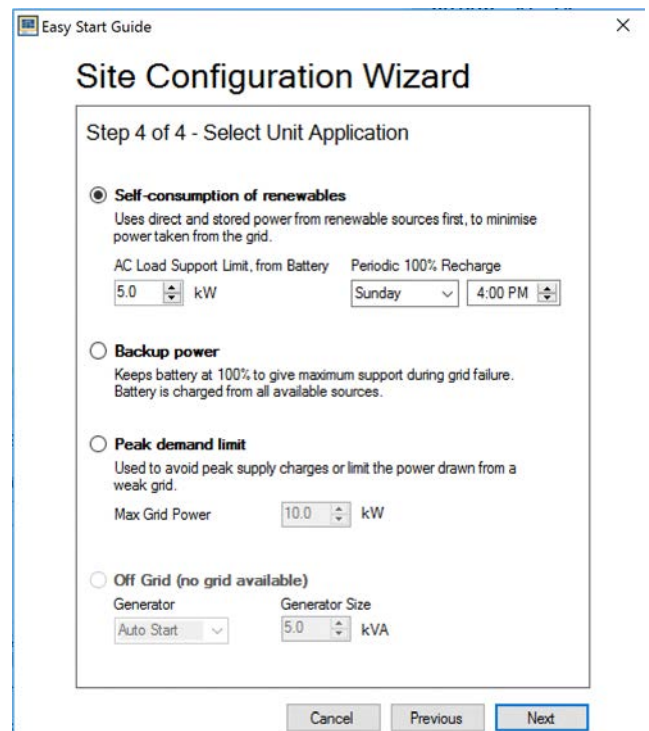

## Entering extra Details and Saving

Any further site information and connection settings may now be entered. If any of the advanced settings need configuring then this should also be done now. Once all the information has been entered and the configuration is complete the Site file along with the Configuration details can be saved to file using the File/Site Information/Save menu (or hit CTRL S key).

## Sending Configuration to the Inverter

The configuration is now ready to transfer to the SP PRO. First of all plug the computer into the inverter using the supplied USB lead then click the Connect button in the Connection Settings. Once connected select the Configuration Settings tab and click the "Configure SP PRO" button.

See [Saving a New Site](#) and [Connection Settings](#) sections for more information.

## Advanced Configuration

Advanced configuration gives access to all the functions of SP LINK allowing the installer to create a Site file and manual configuration that starts with either the default settings or settings created from the Site Configuration Wizard.

The Quick View and Data View tabs read all the information from the connected SP PRO to assist the installer in commissioning and diagnosing the System.

Please remember that if help is require for a function in SP LINK hover the cursor over the heading or right click on the heading to be taken to the relevant section of the SP LINK manual.

## Firmware Update (Easy Start Guide)

The Firmware Update option in the Easy Start Guide is a quick and easy way to update the firmware in the SP PRO without the need to set up a site file. This option is normally used to update firmware before configuring a new system. If the firmware is to be updated in an existing system then refer to Firmware Update page 23

The SP PRO must be connected to the computer running SP LINK via a USB cable or an ATEN or Belkin USB to serial adaptor.

When this option is selected, the **Easy Start Guide, Firmware Update** window is displayed.

**Select USB Device** - If there is more than one SP PRO plugged into the computer, then select the one you wish to update.

**Connect and update firmware:** If the SP PRO has the default User Access Password then just click Connect. Otherwise enter the User Access Password before connecting.

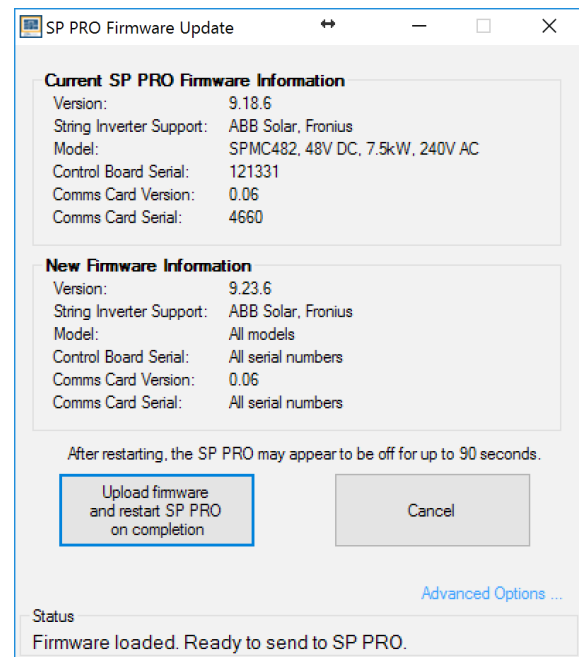
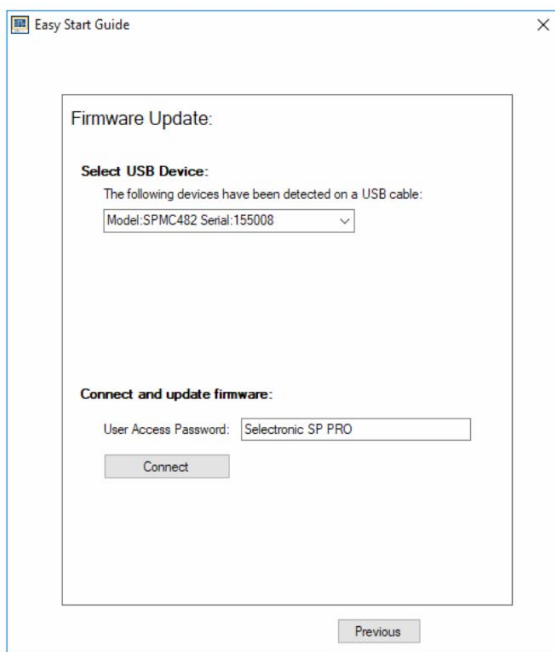

Once SP LINK connects to the SP PRO, the **SP PRO Firmware Update** window will appear. Select "Update Firmware and Restart SP PRO on Completion". If this option is disabled then the firmware is up to date.

When the firmware update process is complete, the **Easy Start Guide, Firmware Update** window appears to allow other SP PRO inverters to be updated. When finished select Previous to go back to the Easy Start Guide.

## Preparing a new site

SP LINK Advanced Configuration will open in the Site Information tab. Information must be entered in the mandatory fields with red stars including information in the lower tabs. Also it is not possible to proceed without setting up and saving the site information into a Site file.

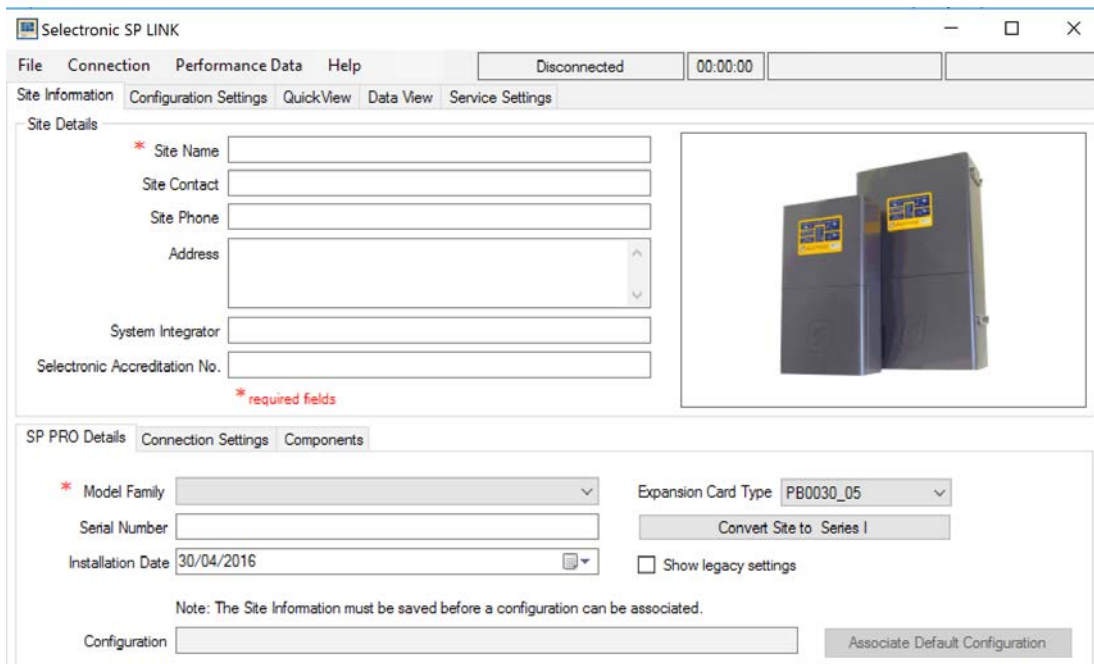

There is a large window on the right side of the Site Information page, click here to place a photo of the system  
 To create a new site file for Series I units, click on Convert to Series I and then proceed with remaining steps.  
 For backward compatibility for SP PRO firmware version prior to 7.0, tick Show legacy settings option. SP LINK will also automatically detect this upon connection to a SP PRO unit with firmware prior to 7.0.  
 It is also helpful to place photos of the various system components under the Components tab.

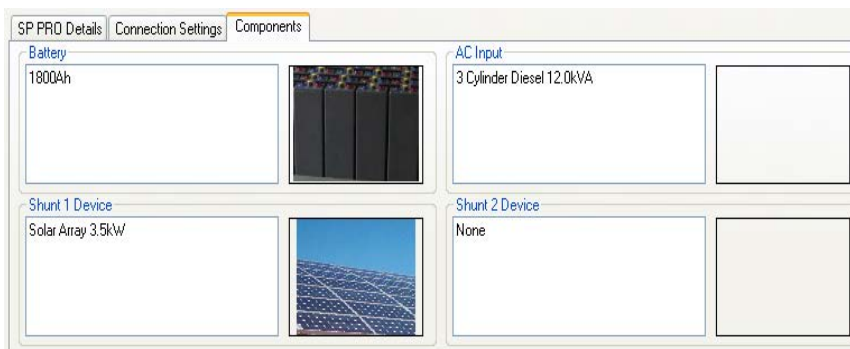

Under Connection Settings please select the Connection Type method to connect to the SP PRO. To connect directly to the USB port of the SP PRO select USB. The model number/serial number of the SP PRO to be connected to can now be selected from the list

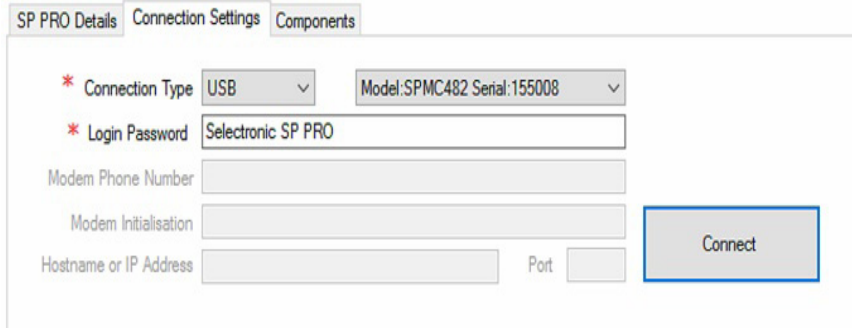



A LOGIN PASSWORD is required for connecting to the SP PRO. SP LINK can only connect with the correct password. The default password is “Selectronic SP PRO”. The Login Password is different to the Setting Passcode.

The LOGIN PASSWORD only needs to be changed if you wish to prevent any connection to the SP PRO. This is particularly important to secure the SP PRO against unauthorised monitoring or modification when the SP PRO is remotely accessible via a Modem or Network connection type. Once connected, the default password may be changed under Service Settings. If the Login Password is lost or forgotten it can only be reset by a procedure that requires someone to be on site. Contact a Selectronic Accredited Integrator.

## Saving a new site

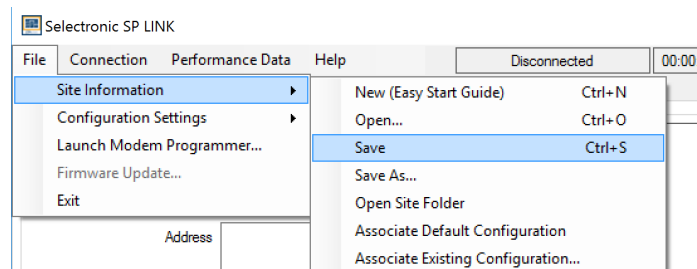
All site information must now be saved.



To save the SP PRO site information, click on File - Site Information - Save.

As this is a new site you will need to chose a common place on the computer to store the site folder, other information about this site such as Performance Downloads and Configuration settings will automatically be placed in this folder, the folder will have the same name as the site. Site files will be named with a .SPLS extension.

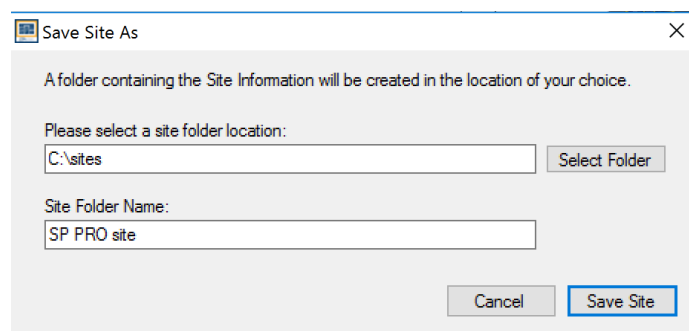

## Manually Preparing a new configuration

You can now start to prepare a manual configuration. The SP PRO configuration is stored in a file within the site file and contains all of the SP PRO settings for transferring into the SP PRO when connecting via SP LINK.

Click on the Configuration settings tab.

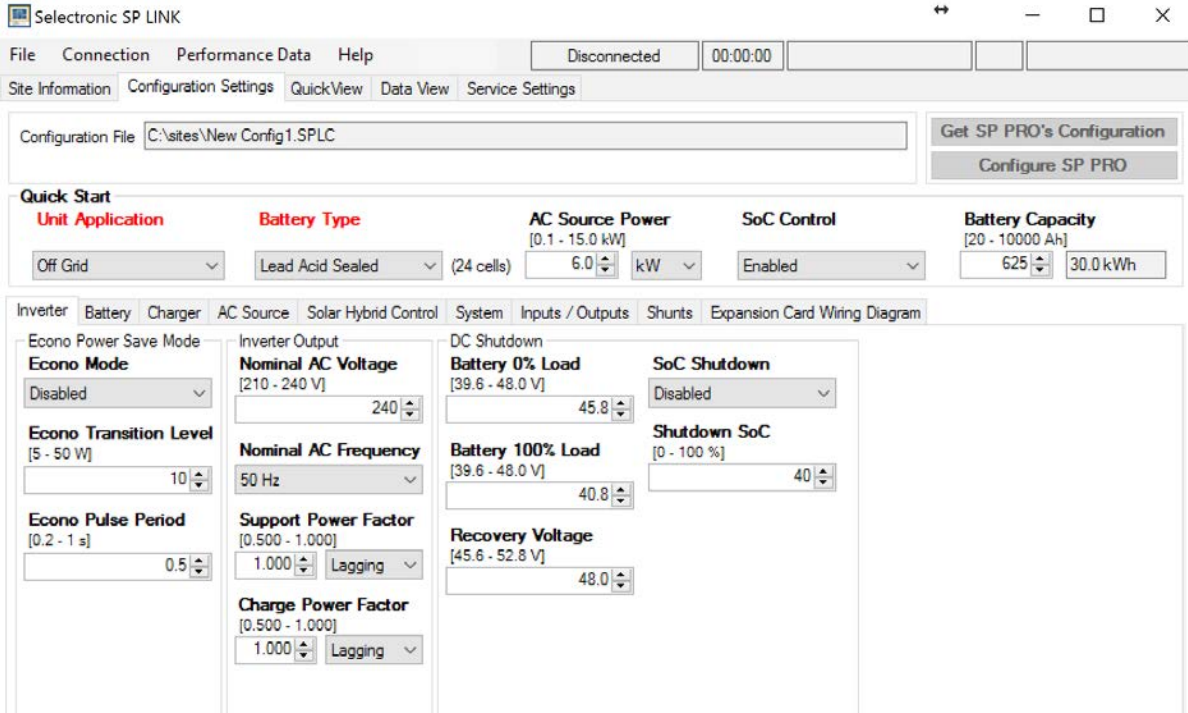

The SP PRO is a very advanced and intelligent product but don't let the large number of settings concern you.



Use the Site Configuration Wizard to set up the standard configurations before setting any advanced functions.

There is a Quick Start section near the top of the page which contains the settings that need to be considered for all applications.

The following table indicates the settings needed to be considered for each system. Most of these configurations are included in the Site Configuration Wizard

### QUICK START - SETTINGS NEEDED FOR ALL SYSTEMS

SETTING	CONFIGURATION TAB	COMMENTS
Unit Application	Quick Start	Set to Off Grid, On Grid (Solar Hybrid) or Mobile
Batteryless Mode	Quick Start	Set to configure SP PRO GO to run without battery. All battery and charger related Settings are greyed out. Needs optional batteryless kit installed
Battery Type	Quick Start	Set default battery voltage operating range
AC Source	Quick Start	Maximum capacity of grid supply or AC generator
SoC Control	Quick Start	Enable for battery State of Charge (SoC) management
Battery Capacity	Quick Start	Amount of connected battery storage

The following tables have a minimal list of settings to consider for each particular application.

SOLAR HYBRID (ON GRID) GRID BACKUP SETTINGS		
SETTING	CONFIGURATION TAB	COMMENTS
AC Source Disconnect Alarm	System	Enable to alert users that system is running on battery supply
SoC Shutdown	Inverter	The grid backup battery limit point
Periodic Recharge	Battery	Recharge self discharge losses in batteries held in Float for long period of time.
Grid Input and Export plus Charge Limits	Solar Hybrid Control	Set at least one Solar Hybrid priority with the required limits of grid supply and battery SoC usage

SOLAR HYBRID (ON GRID) GRID BACKUP PLUS SOLAR SETTINGS		
SETTING	CONFIGURATION TAB	COMMENTS
AC Source Disconnect Alarm	System	Enable to alert users that system is running on battery supply
SoC Shutdown	Inverter	The grid backup battery limit point
Periodic Recharge	Battery	Recharge self discharge losses in batteries held in Float for long period of time.
Shunt Name and Limits	Shunts	For DC Coupled Solar
String Inverter and Number	System	For Managed AC Coupled solar
Grid Input and Export plus Charge Limits	Solar Hybrid Control	Set at least one Solar Hybrid priority with the required limits of grid supply and battery SoC usage

SOLAR HYBRID (ON GRID) SELF CONSUMPTION SETTINGS		
SETTING	CONFIGURATION TAB	COMMENTS
Shunt Name and Limits	Shunts	For DC Coupled Solar
String Inverter and Number	System	For Managed AC Coupled solar
Grid Input and Export plus Support and Charge Limits	Solar Hybrid Control	Set at least one Solar Hybrid priority with the required limits of grid supply and battery SoC usage

OFF GRID SETTINGS		
SETTING	CONFIGURATION TAB	COMMENTS
Shunt Name and Limits	Shunts	For DC Coupled Solar
String Inverter and Number	System	For Managed AC Coupled solar
Generator Controller	AC Source - Generator Controller	Disable if manual start generator



See Configuration Settings section for detailed information on all settings.

### Saving a new configuration

The configuration settings should now be saved to file before sending them to the SP PRO.

To save the SP PRO configuration settings, click on File - Configuration Settings - Save.

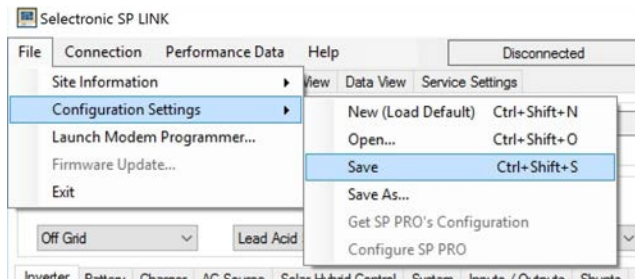

The configuration settings will be saved in the same location as the site information saved in the previous step. SP LINK will automatically use the default file name Config1 prefixed with the site name.

The configuration settings are now stored on the computer. The SP PRO can be configured with these settings at any time once the computer is linked and connected to the SP PRO.

### Connecting to the SP PRO

Plug the SP PRO into the computer with the supplied USB cable. The SP PRO will be automatically detected by the computer and SP LINK. When this occurs it will be indicated by SP LINK showing both model and serial number under Connection Settings.

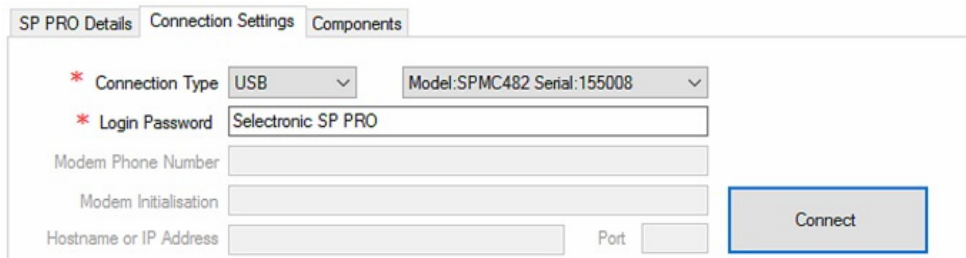

Now we can connect to the SP PRO. Either clicking the Connect button or in the Connection menu, click Connect.

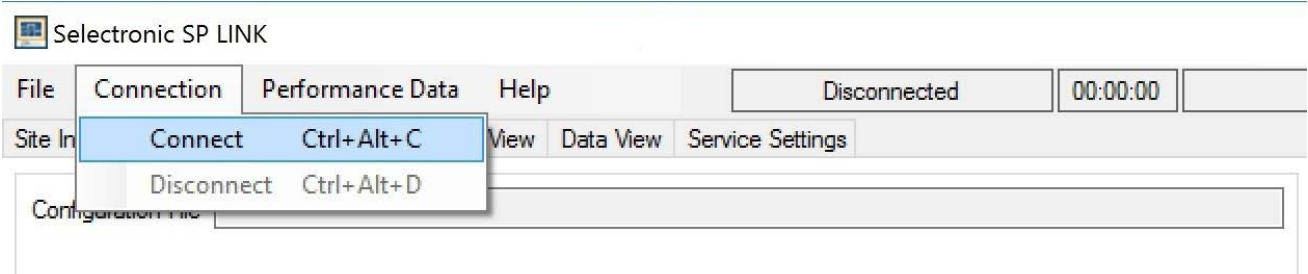

SP LINK is now connected through to the SP PRO. SP LINK will notify you if a connection is unable to be established.

It is important to note that the SP PRO has NOT yet been configured with any of the setting changes made at this time. This is performed in the next step.

SP LINK will notify you if the connected SP PRO does NOT have the same model number and serial number as detailed in the SP LINK “SP PRO Details” tab. SP LINK will also prompt you, as required, to update the time within the SP PRO from the computers time.

### Connection status bar

The connection status bar appears in the top right of the screen in SP LINK and is always visible. It is divided into 5 sections as listed below:



**1** - In a multi phase system (Three phase or split phase), designates the phase to which you are connected. This is blank in a single phase system.

**2- Connected:** SP LINK is connected to the SP PRO. Configuration settings, firmware updates, Performance downloads and Live data readings are available.



**Disconnected:** SP LINK is not connected to the SP PRO



**Busy:** SP LINK is busy doing a download or firmware update to the SP PRO

**3.** The duration in hh:mm:ss that this session of SP LINK has been connected to the SP PRO.









**4.** The Date and Time of Day within the SP PRO

**5.** The Status of the AC input of the SP PRO.

The left hand icon is the “AC Source Status” which is green tick  when the grid is in tolerance and red  when the grid is out of tolerance according to the settings in Configuration Setting > AC Source > AC Input menu.

The right hand icon is the “Output Mode” of the SP PRO inverter. This is red  when the SP PRO output is off, green tick  when the output is on and in stand alone, and green arrows  when the output is in sync and connected to the AC source input.

Five examples of Connection Status bar are shown, summarised as follows:

	1	2	3	4	5
A	L1	Connected	00:19:56	14/10/2016 - 12:18:10	 
B	L2	Connected	00:10:18	14/10/2016 - 12:08:32	 
C		Connected	00:23:52	14/10/2016 - 12:22:06	 
D		Connected	00:21:13	14/10/2016 - 12:19:27	 
E		Disconnected	00:00:00		

**A.** SP LINK is connected to the phase 1 (L1) SP PRO of a multiphase system. The AC source is in tolerance and the SP PRO is synchronised to the AC Source input.

**B.** SP LINK is connected to the phase 2 (L2) SP PRO of a multiphase system. The AC source is in tolerance but the SP PRO is not synchronised to the AC Source input and is running stand alone.

**C.** SP LINK is connected to the SP PRO in a single phase system. The AC source is out of tolerance and therefore the SP PRO is not synchronised to the AC Source input and is running stand alone.

**D.** SP LINK is connected to the SP PRO in a single phase system. The AC source is in tolerance but the SP PRO is in Idle (inverter section is off). The SP PRO is in bypass and the AC Source input is running the loads

**E.** SP LINK is not connected to the SP PRO.



## Configuring the SP PRO



To avoid unexpected operation, the SP PRO is prevented from turning on until a configuration setting has been saved by clicking “Configure SP PRO”. The ON LED on the front panel will flash red until the SP PRO has been configured for the first time or after a reset to factory defaults.

With SP LINK connected to the SP PRO, Click “Configure SP PRO” from the File - Configuration Settings menu or the button on the Configuration Setting page.



Configure SP PRO

SP LINK will - unless “Configure SP PRO” has just been performed - warn that all settings will be overwritten.

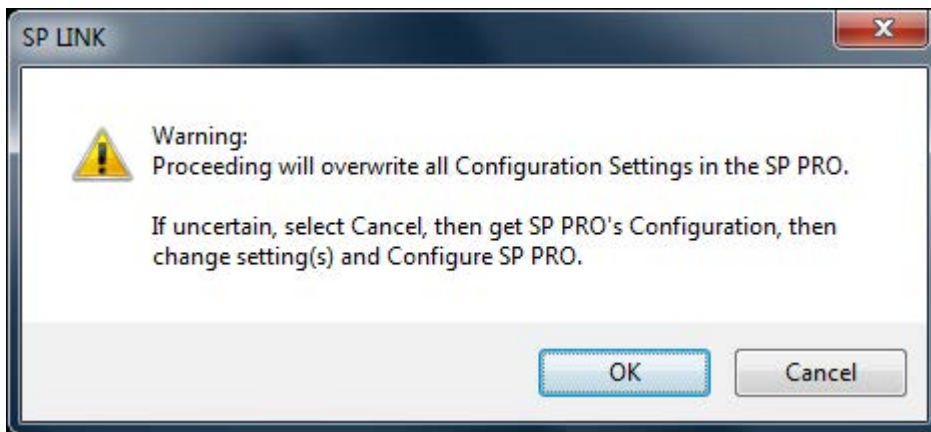

For security purposes, to ensure no-one can tamper with the SP PRO configuration settings, you will now be asked to enter the passcode. This passcode will remain active for five minutes or until the SP PRO is disconnected and will not need to be re-entered until then.



The default passcode is 74, however you can alter this if you wish. We will cover altering the passcode when we get to “Service Settings”.

Once you have entered the passcode click “OK”

SP LINK will verify passcode and configure the SP PRO with these changes.

SP LINK will indicate if for any reason the Configuration was unsuccessful.

You have now transferred all the Configuration Settings shown in SP LINK into the SP PRO. The settings take immediate effect and can be performed with the SP PRO fully operational.



To avoid unexpected operation, the SP PRO is prevented from turning on until a configuration setting has been saved by clicking “Configure SP PRO”. The ON LED on the front panel will flash red until the SP PRO has been configured for the first time or after a reset to factory defaults.

## Connection Settings

The connection settings (shown on the next page) show all the connection methods available between SP LINK and the SP PRO . The connection settings need to be set depending on which other communication method is being used. Details of the chosen connection type are stored with the site file.



### LOGIN PASSWORD

A LOGIN PASSWORD is required for connecting to the SP PRO. SP LINK can only connect through to the SP PRO with the correct password. The default password is “Selectronic SP PRO”. This is different to the setting passcode.

### USB - Local connection.

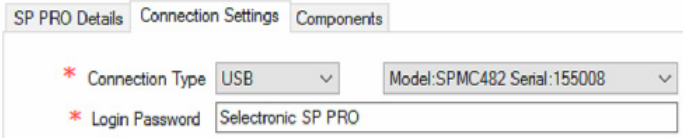

SP LINK will automatically detect and list all SP PRO inverters plugged into the PC via their USB ports. Select the appropriate SP PRO and click the CONNECT button.

Select USB when connecting via a Wireless Zigbee device.

The ATEN or Belkin USB to serial adaptors may also be connected using the USB option. In this case SP LINK will Automatically switch to SERIAL on connection to the SP PRO and save to the Site File.

**NOTE** - An alternative method for connecting to USB devices is selecting the **SERIAL Connection Type** then:

- Unplug the USB lead from the computer running SP LINK. Leave it plugged into the SP PRO.
- Select Serial **Connection Type** and note the available COM ports.
- Plug the USB lead back into the computer and wait until a new COM port appears in the list.
- Select the new COM port and click the CONNECT button.

### SERIAL - Local connection.

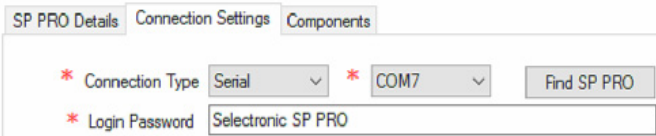

Use SERIAL connection Type when using a RS232 serial connection or as an alternative to a USB connection.

Once all cables are connected and in place, press FIND SP PRO - this will search through all PC ports and find the connected SP PRO and set connection parameters. This Option was previously called Direct.

### WIRELESS - Local connection.

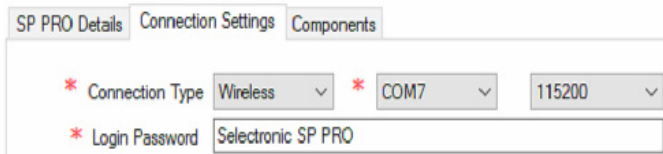

Use Wireless when connecting via a RS232 wireless device. This setting operates similar to SERIAL but allows for the extra delays normally present in a wireless link

### MODEM - Remote dial-up connection.

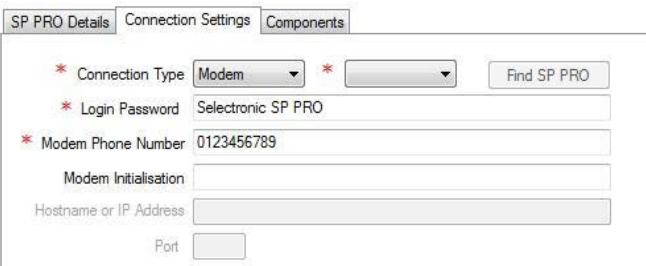

For MODEM connections, select the PC COM port that the modem is connected to. Enter the MODEM PHONE NUMBER. This is the number that SP LINK will dial when you select CONNECT. MODEM INITIALISATION can be left blank when using Selectronic supplied modems but may be required for other modem types. Consult the modem supplier if unsure.

### NETWORK - IP connection.

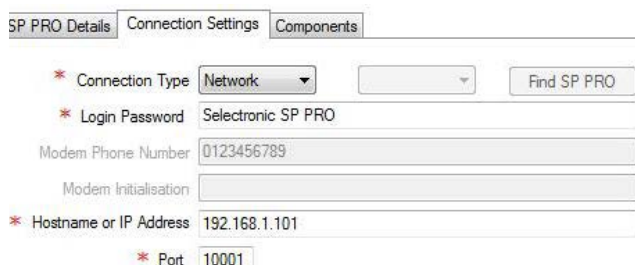

Connection to the SP LINK via a local NETWORK is made using the optional SP PRO Ethernet Adaptor Lead, stock code 005081. enter the HOSTNAME or IP ADDRESS of the serial/Ethernet adaptor and the IP PORT number of the serial connection to the SP PRO.

### LOCAL PORT SCANNER.

Detected devices:  
 192.168.1.212

Use this function to find the IP address of the SP PRO that is connected to the local network via the optional Ethernet adaptor, stock code 005081. First enter the port number of the adaptor then click “Scan Local Network”.

Consult the installation guide supplied with the Ethernet adaptor or an IT specialist for further information.

### Customising SP LINK to suit the site

The SITE INFORMATION screen on SP LINK allows you to record specific site details that are individual to the installation, such as the SITE NAME, the SYSTEM INTEGRATOR, the inverter SERIAL NUMBER as well as including a photo of the site.

In the SP PRO DETAILS screen you can choose from earlier saved configuration files. As an example, you may have two sets of settings for the inverter saved within SP LINK; one for NORMAL everyday use, and one for HOLIDAY use. In the holiday file you may have included automatic garden watering, switching security lights on and off or even switching off the inverter for periods of time.

Changing these settings is as easy as browsing the saved files through the FILE - SITE INFORMATION - ASSOCIATE EXISTING CONFIGURATION menu option or clicking Associate Existing Configuration and selecting the appropriate configuration then clicking on OPEN. This will now load in those settings ready to be Configured into the SP PRO.

## Performance Data Retrieval

The SP PRO collects and stores information regarding the complete power system and the operation of the SP PRO. This information can be downloaded to review the system performance or in assisting to identify any potential areas of concern.

From the drop down menu in “Performance Data” you can choose the type of data and how much of it to download from the SP PRO to the computer.

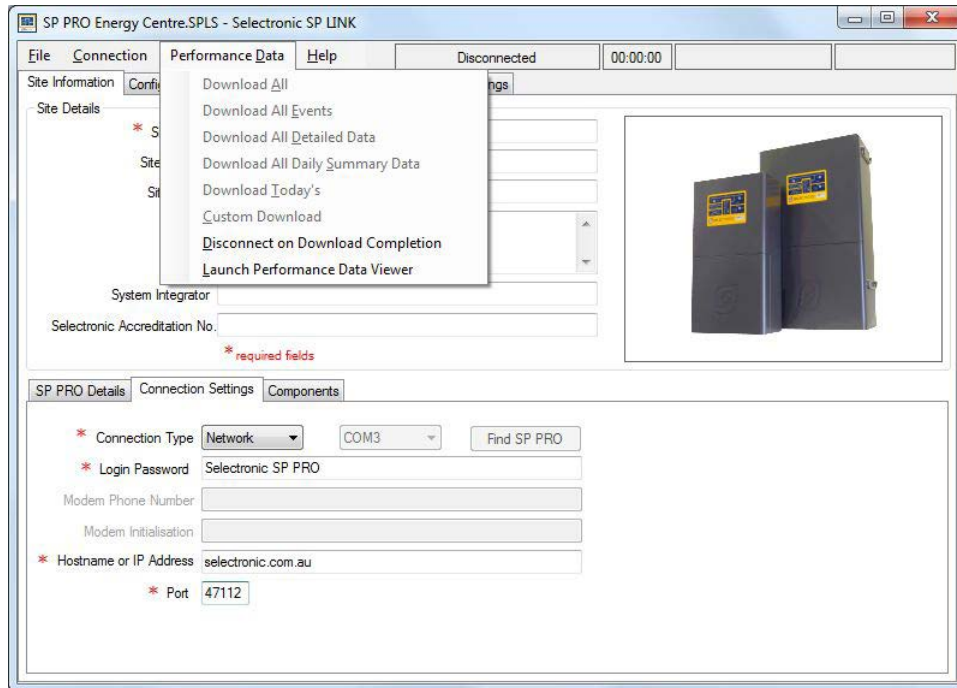

The Performance Data menu gives you the following options but choosing **Download All** will ensure all the data is captured::

### Download All

This is the preferred download to use as it contains Events, Detailed, Daily Summary, Configuration and Unit Information. When Seeking support assistance from your Selectronic Accredited Integrator or from Selectronic Support, please perform a Download All and email The .zip file contained in the download directory.

### Download Events

Download just Event records - what happened and when

### Download Detailed Data

Download just the Detailed data - averages of all parameters like AC Load and Battery Voltage

### Download Daily Summary Data

Download just the Daily Summary data - total energy usages on a daily basis

### Download Today's

Download all records for Today

### Custom Download

Choose the date range and what types of data to download.

You may also wish to select Disconnect on Download Completion from the menu to avoid high data costs on Network or Modem connections.

You can also select Launch Performance Data Viewer directly without having to download any data. This will then allow you to choose previously downloaded data from this or other sites.

## Performance Data Viewer

Once the Performance Data Download is complete, you can either  
 Click OK to continue using SP LINK,  
 Click Open Download Folder to see the Performance Data files just downloaded,  
 Click Launch Performance Viewer\* to view graphically the Performance Data.

\* - Requires Microsoft Excel 2003 or later

The Performance Data Viewer automatically loads and presents the Performance Data graphically and in predefined graphs or a customised graph with any choice of Performance Data plus displays all the Event logging and Daily Performance Data.

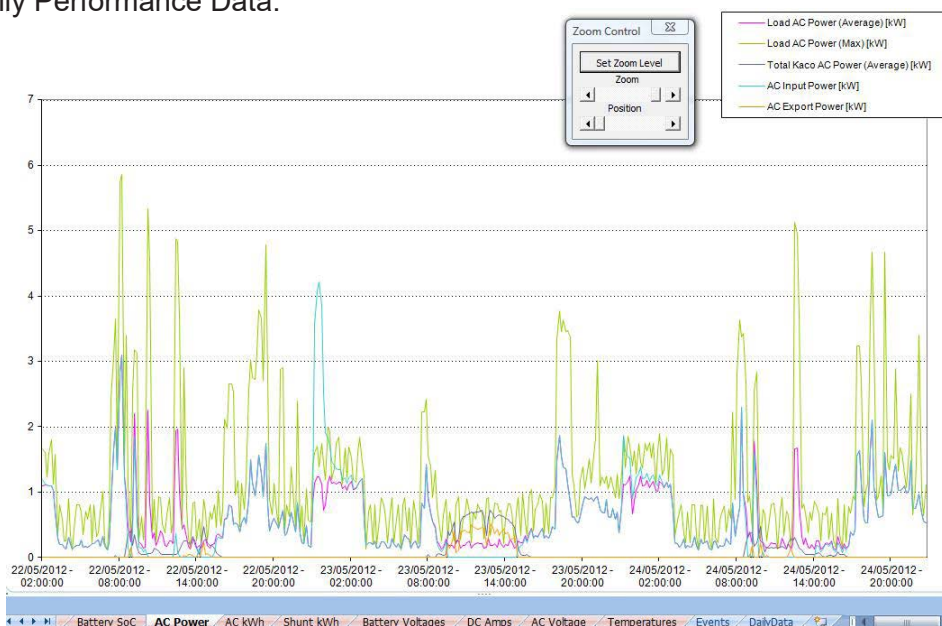

The “Events” tab lists all the Operational and Alert events along with their time stamp and a snap shot of the readings at the time. The Operational events occur during normal operation of the system.

An Alert event normally indicates that there is an issue with the system. For further information on Alert events, see “Appendix One Alert Messages” on page 86 .The table in this section outlines all the SP PRO ALERT type event messages, the most likely cause and possible remedies.

[Click here for Appendix One Alert Messages on page 86](#)

Date/Time Stamp [ddMM/yyyy - HH mm:ss]	Event Type	Event Description	Voltage (Instantaneous) [V DC]	Voltage (Instantaneous) [V DC]	AC Current (Instantaneous) [A]	AC Current (Instantaneous) [A]	Shunt 1 Current (Instantaneous) [A]	Shunt 2 Current (Instantaneous) [A]	Power (Instantaneous) [kW]	AC Power (Instantaneous) [kW]	Power (Instantaneous) [kW]	Voltage (Instantaneous) [V AC]	State of Charge (Instantaneous) [%]
23/11/2012 - 13:40:16	Operations	Digital Control Out 3 - On	26.7	13.3	138.8	0	0	0	0	4.09	0	240.7	89.5
23/11/2012 - 13:25:58	Alert	Inverter - AC Source out of tolerance Beeper Off	26.4	13.2	135.6	0	0	0	0	3.94	0	240.6	99.5
23/11/2012 - 13:25:58	Alert	Inverter - AC Source out of tolerance Beeper On	26.4	13.2	136	0	0	0	0	3.96	0	240.3	99.5
23/11/2012 - 13:25:58	Alert	Inverter - AC Source out of tolerance Beeper Off	26.4	13.2	135.4	0	0	0	0	3.95	0	240.5	99.5
23/11/2012 - 13:25:58	Operations	AC Source - Minimum Sync Frequency detected	26.4	13.2	136	0	0	0	0	3.96	0	240.3	99.5
23/11/2012 - 13:25:56	Alert	Inverter - AC Source out of tolerance Beeper On	26.4	13.2	135	0	0	0	0	3.94	0	240.5	99.5
23/11/2012 - 13:25:56	Operations	AC Mode - Standalone begin	26.4	13.2	135	0	0	0	0	3.94	0	240.5	99.5
23/11/2012 - 13:25:56	Operations	AC Source - Minimum Sync Voltage detected (S)	26.4	13.2	135	0	0	0	0	3.94	0	240.5	99.5
23/11/2012 - 13:25:48	Alert	Inverter - AC Source out of tolerance Beeper Off	26.4	13.2	135.9	0	0	0	0	3.96	0	240.4	99.5
23/11/2012 - 13:25:48	Alert	Inverter - AC Source out of tolerance Beeper On	26.4	13.2	136.1	0	0	0	0	3.97	0	240.6	99.5
23/11/2012 - 13:25:48	Alert	Inverter - AC Source out of tolerance Beeper Off	26.4	13.1	135.5	0	0	0	0	3.95	0	240.8	99.5
23/11/2012 - 13:25:48	Operations	AC Source - Minimum Sync Frequency detected	26.4	13.2	136.1	0	0	0	0	3.97	0	240.6	99.5
23/11/2012 - 13:25:41	Alert	Inverter - AC Source out of tolerance Beeper On	26.3	13.1	135.6	0	0	0	0	3.95	0	240.2	99.5
23/11/2012 - 13:25:41	Operations	AC Mode - Standalone begin	26.3	13.1	135.6	0	0	0	0	3.95	0	240.2	99.5
23/11/2012 - 13:25:41	Operations	AC Source - Minimum Sync Voltage detected (S)	26.3	13.1	135.6	0	0	0	0	3.95	0	240.2	99.5
23/11/2012 - 13:25:31	Operations	Digital Control Out 3 - Off	26.3	13.1	136.2	0	0	0	0	3.95	0	240.5	99.5
23/11/2012 - 13:24:53	Operations	Charger - Initial Stage Start	24.3	12.1	-22.5	0	0	0	0.55	-0.55	0	239.7	99.5
23/11/2012 - 13:23:52	Operations	Digital Control Input 3 - On	24.4	12.2	-22.5	0	0	0	0.55	-0.55	0	239.7	99.5
23/11/2012 - 13:23:52	Operations	Generator Controller - Auto Start Available	24.4	12.2	-22.5	0	0	0	0.55	-0.55	0	239.7	99.5
23/11/2012 - 13:23:49	Operations	Digital Control Input 3 - Off	24.4	12.2	-22.8	0	0	0	0.56	-0.56	0	239.8	99.5
23/11/2012 - 13:23:49	Operations	Generator Controller - Auto Start NOT Available	24.4	12.2	-22.8	0	0	0	0.56	-0.56	0	239.8	99.5
23/11/2012 - 13:23:49	Operations	Digital Control Input 3 - On	24.4	12.2	-22.8	0	0	0	0.56	-0.56	0	239.7	99.5
23/11/2012 - 13:23:49	Operations	Generator Controller - Auto Start Available	24.4	12.2	-22.8	0	0	0	0.56	-0.56	0	239.7	99.5
23/11/2012 - 13:23:47	Operations	Digital Control Input 3 - Off	24.4	12.2	-22.6	0	0	0	0.56	-0.56	0	239.8	99.5
23/11/2012 - 13:23:47	Operations	Generator Controller - Auto Start NOT Available	24.4	12.2	-22.6	0	0	0	0.56	-0.56	0	239.8	99.5
23/11/2012 - 13:23:47	Operations	Digital Control Input 3 - On	24.4	12.2	-22.8	0	0	0	0.56	-0.56	0	239.6	99.5
23/11/2012 - 13:23:47	Operations	Generator Controller - Auto Start Available	24.4	12.2	-22.8	0	0	0	0.56	-0.56	0	239.6	99.5
23/11/2012 - 13:22:40	Operations	Digital Control Input 1 - Off	25.1	12.5	-21.8	0	0	0	0.55	-0.55	0	239.5	100
23/11/2012 - 13:22:40	Operations	Charger - Return to Float Stage	25.1	12.5	-22.4	0	0	0	0.57	-0.57	0	239.5	100
23/11/2012 - 13:22:40	Operations	Digital Control Input 1 - On	25.1	12.5	-22.3	0	0	0	0.56	-0.56	0	239.8	100
23/11/2012 - 13:22:40	Operations	Charger - Float Stage Start from digital input	25.1	12.5	-22.3	0	0	0	0.56	-0.56	0	239.8	100
23/11/2012 - 13:22:40	Operations	Digital Input - Charger to Float Stage	25.1	12.5	-22.3	0	0	0	0.56	-0.56	0	239.8	100
23/11/2012 - 13:22:40	Operations	Digital Control Input 1 - Off	25.1	12.5	-22.1	0	0	0	0.56	-0.56	0	239.7	100
23/11/2012 - 13:22:39	Operations	Charger - Return to Float Stage	25.1	12.5	-22	0	0	0	0.57	-0.57	0	239.7	62
23/11/2012 - 13:22:39	Operations	Digital Control Input 1 - On	25.1	12.5	-22.2	0	0	0	0.57	-0.57	0	239.8	62
23/11/2012 - 13:22:39	Operations	Charger - Float Stage Start from digital input	25.1	12.5	-22.2	0	0	0	0.57	-0.57	0	239.8	62

## Firmware Update

SP LINK provides a convenient and simple way to update the firmware in the SP PRO inverter. This only needs to be performed if you have been specifically requested to update the firmware which can be done either on-site or remotely.

Before updating firmware make sure you have the latest version of SP LINK, available at <http://www.selectronic.com.au/splink> which contains the most recently released firmware.

### SAVE CURRENT CONFIGURATION

If you are updating an existing system then it is recommended that the configuration settings within the SP PRO be saved to file before updating firmware:

1. Connect to the SP PRO.
2. Select the Configuration Settings tab.
3. Click the Get SP PRO's Configuration button.
4. Save Configuration settings. (File > Configuration Settings > Save)

### SET STRING INVERTER

If the system is using or will use Managed AC Coupling with a Selectronic Certified grid inverter then it is important to set the **String Inverter** setting and configure the SP PRO before Firmware Update. Once this is done the Firmware update process will automatically selected the compatible firmware  
See String Inverter on page 52.

### FIRMWARE UPDATE PROCESS

Select File > Firmware Update and the SP PRO Basic Firmware Update window will appear and show the Current and the New SP PRO Firmware Information.

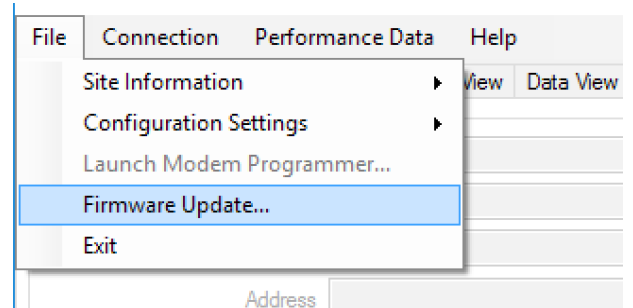

### Update Firmware and restart SP PRO on Conclusion:

Use this option to update the firmware in the SP PRO to the firmware version that is included in SP LINK. If you are using the latest SP LINK then this will be the latest firmware.

Once the update is completed and the SP PRO has restarted, this window will close. You are now able to connect to the SP PRO.

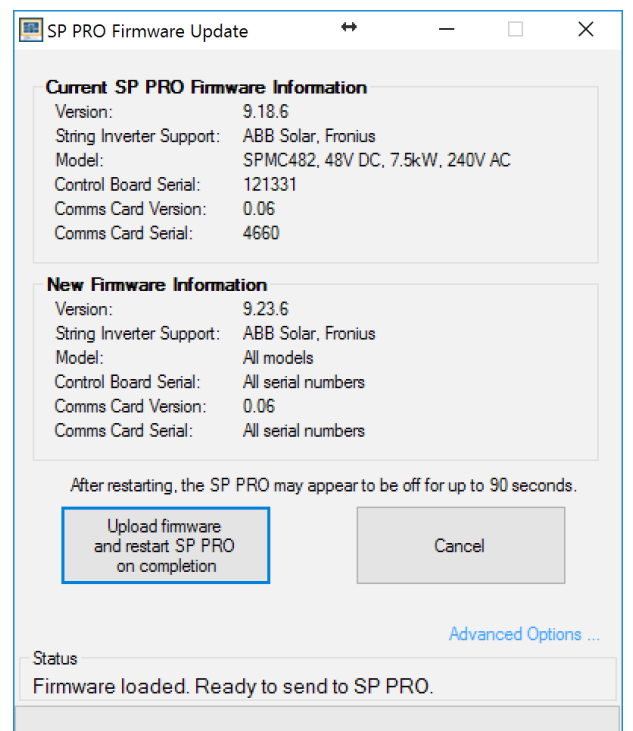

## FIRMWARE UPDATE PROCESS - ADVANCED OPTIONS

If you wish to load firmware from file or set up a scheduled restart after the firmware has been sent, then Select

*Advanced Options....* This will take you to a new screen.

**Step 1** You can load the latest firmware (Use the firmware included in SP LINK). If you choose this option then the firmware that is compatible with the string inverter that is set in Configuration Settings > System > String Inverter (see page 52.) will be selected. If no string inverter is configured then you are able to select the compatible string inverter.

This option will perform a firmware update for both the inverter and the advanced communication card (if installed).

OR

Select firmware from file (Load Firmware from File). If you choose this option you can either select the firmware file for the inverter or for the Advanced communications card (ACC). If you wish to update both the inverter and ACC firmware from file then they need to be done one at a time.

**Step 2** Check that the **Current SP PRO firmware Information** and the **New firmware Information** are correct before proceeding.

If you wish to **Automatically restart SP PRO if firmware update is successful**, then check this box. **WARNING:** During the restart AC LOAD will be interrupted.

Click **Program SP PRO**.

SP LINK will begin the update process. There are several stages and this can be monitored in the Status area at the bottom of the SP PRO Firmware Update screen.

When complete there will be either a **Automatically restart SP PRO if firmware update is successful** or Status will indicate: "Firmware Transferred to SP PRO. Proceed with Step 3 (see next page)."



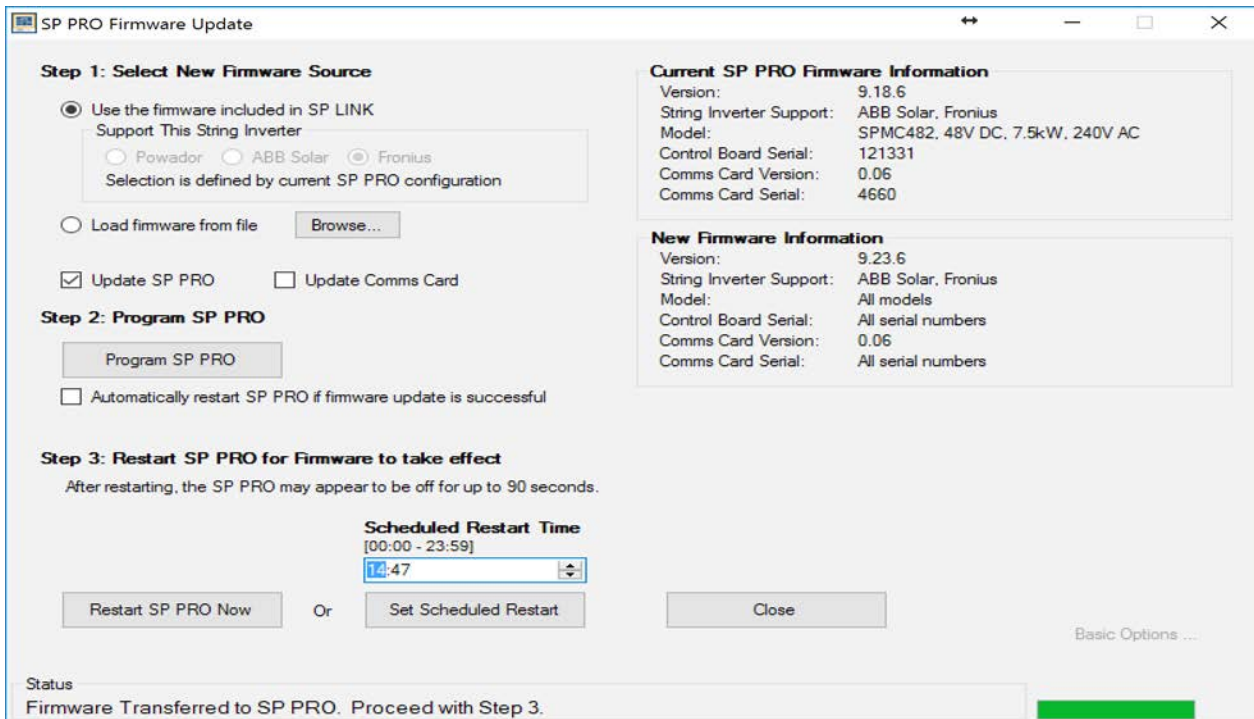

**Step 3** If **Automatically restart SP PRO if firmware update is successful** was not checked then the SP PRO must be restart at this stage to complete the firmware update.

WARNING: During the restart AC LOAD will be interrupted.

There are two Restart options:

Click **Restart SP PRO Now**.

The SP PRO will restart and the Firmware Update window will close. SP PRO will appear to be off for a further 90 seconds then revert to Idle mode by default.

Firmware Update is now complete and the SoC window will be displayed

OR

Set the **Scheduled Restart time** when a 90 second interruption in power is most convenient.

The SP PRO uses 24 hour time.

Click **Set Scheduled Restart**.

The SP PRO is now set to restart at that time and will continue to operate normally.

(If you change your mind about the scheduled restart time, simply set a new value which will override the first. Or if you click Restart SP PRO Now, the inverter will be restart immediately and any scheduled restart will be disabled.)

Click Close.

At the scheduled time, the SP PRO will restart, appear to be off for 90 seconds, then resume operation as it was prior to being restart.

Firmware Update is now complete.

### **AUTOMATIC RESETTING THE STATE OF CHARGE (SoC)**

During the firmware update process SP LINK reads the SoC from the SP PRO.

When the SP PRO is restarted as part of the firmware update process, the SoC in the SP PRO is lost.

Reconnecting SP LINK after the firmware update is completed will initiate an automatic updated of the SoC back to the SP PRO.

If the SP PRO is communicating with a Battery Management System (such as LG Chem) then the SoC is automatically set by the BMS and this process does not occur.

### **AFTER UPDATING FIRMWARE**

Connect SP LINK to the SP PRO.

For existing systems, load the saved Configuration file into SP LINK and make any required changes to your configuration settings. Check the **String Inverter** setting as this may have changed during the firmware update process (See String Inverter on page 52.)

For new system it is recommended that the Site Configuration Wizard be used now to configure the SP PRO.

**Note:** For updates from a firmware version that is less than 7.00 to a version that is 7.00 or greater, some settings will no longer be active and reprogramming Configuration Settings may be required. For full details see the document “Migrating Legacy Settings” in the Help menu within SP LINK.

Program your previously saved configuration settings back into the SP PRO using the Configure SP PRO button.



# Configuration Settings

The SP PRO series are very advanced and intelligent products with a large number of settings to suit virtually any application. By default, the SP PRO will run as an off-grid inverter charger and through enabling additional features within the SP PRO, many differing system objectives can be achieved. At this stage you can choose to either start a new configuration using the default settings OR use the Site Configuration Wizard to setup a more advanced starting point.

The Configuration Settings are divided into named sections indicating the types of settings within them. Each tab highlights a different configuration area within the SP PRO. To access these settings, click on the various section tabs.

Settings can be changed by either clicking on the drop down list or directly changing the value. Every time you change a setting the title of that setting becomes highlighted in yellow. This is to remind you that you have changed this setting. This highlight disappears when you either save the configuration to file or the SP PRO.(Hit "Configure SP PRO" button).

The following pages detail each tab and individual setting contained within.

## Quick Start

The Quick Start section provides the settings needed to be considered for all applications.

**Unit Application** determines how you will use the SP PRO.

- Off Grid for remote area homes where a backup motor generator will be used and no grid connection is available. (SP PRO AU ONLY)
- Mobile for Motor homes, Caravans & Boats (SP PRO AU ONLY)
- On Grid (Solar Hybrid) where you wish to feed Solar, Wind or Hydro power to the electricity grid. Use this setting for Self Consumption of the Solar or Wind power whilst providing back up power as required.

**Quick Start**  
**Unit Application**

Off Grid ▼

**Battery Type** programs the SP PRO with the appropriate default charging parameters.



The default parameters will be suitable for most battery brands but to ensure maximum battery performance and life, please refer to the battery manufacturers recommendations when programming Battery charging parameters. (Charger tab).



**IMPORTANT:** When using Lithium Battery or similar technologies with the SP PRO inverter, the battery bank **MUST** be fitted with a Battery Management System (BMS) that monitors and fully protects the battery bank. The BMS **MUST** have its own independent disconnect that will fully isolate the battery bank from the system in the event of an adverse or alarm condition.

**Battery Type**

Lead Acid Sealed ▼ (24 cells)

**BATTERYLESS** (SP PRO GO ONLY with optional Batteryless kit) allows the SP PRO GO to operate without a battery bank. The SP PRO GO is powered from an internal power supply via the AC source input. When in this mode all battery functions including Charging, Load support and backup power are disable and the inverter will remain in "Idle". All settings are disabled with the exception of Alarm, Communication and String Inverter (in System Tab).

**Battery Type**

Batteryless ▼

**AC Source Power** configures the maximum allowable power drawn from the AC supply whether it be from a grid supply or motor generator set. Using the right hand drop down menu choose kW, kVA or Amps. The setting will scale accordingly

The SP PRO will try and keep its power draw below this value and will only exceed it when the load is greater than the inverter capacity plus this value.

**AC Source Power**  
[0.1 - 15.0 kW]

6.0 ▼ kW ▼

**State of Charge (SoC) control** gives you the option of controlling the system with either a calculated state of charge or by the battery voltage.

It is important to note, that for State of Charge control to operate correctly, the SP PRO must be able to read and monitor any charge or discharge of the battery, external to the SP PRO. External current shunt will need to be installed for all DC charging sources of DC loads. Currents shunts are configured under the "Shunts" tab. The SP PRO does NOT need a shunt for it's own battery current or for any installed AC coupled solar.

**SoC Control**

Enabled ▼

Enabling State of Charge Control provides greater flexibility in system programming and will allow the battery indicator on the front of the inverter to display usable charge in the battery like the fuel gauge in your car. If State of Charge is disabled the battery indicator will show the battery voltage from the Low DC Shutdown level (no LEDs on) to the Float Charge Voltage level (all LEDs on).

**Battery capacity** is used by the SP PRO to calculate the battery's State of Charge. To determine the Battery Capacity first determine the approximate average C rate that the batteries will be discharged over a day. Then use the battery manufacturers specification to determine the battery capacity at this C rate For example, if the batteries are slowly discharged (such as a typical off grid system) then it is likely you would use the C100 or C120 rating, if the batteries will be discharged quickly (typical Solar hybrid system) then likely the C10 - C20 rate.

NOTE: It is safest to use a lower value of battery capacity if unsure

**Battery Capacity**  
[20 - 10000 Ah]

625 ▼ 30.0 kWh



## Inverter Settings

The Inverter tab shows the output settings and minimum battery levels for the inverter to operate within.

Inverter	Battery	Charger	AC Source	Solar Hybrid Control	System	Inputs / Outputs	Shunts	Expansion Card Wiring Diagram
<div style="display: flex; justify-content: space-between;"> <div style="width: 25%;"> <p><b>Econo Power Save Mode</b></p> <p><b>Econo Mode</b></p> <p>Disabled</p> <p><b>Econo Transition Level</b> [5 - 50 W]</p> <p>10</p> <p><b>Econo Pulse Period</b> [0.2 - 1 s]</p> <p>0.5</p> </div> <div style="width: 30%;"> <p><b>Inverter Output</b></p> <p><b>Nominal AC Voltage</b> [210 - 240 V]</p> <p>240</p> <p><b>Nominal AC Frequency</b></p> <p>50 Hz</p> <p><b>Support Power Factor</b> [0.500 - 1.000]</p> <p>1.000 Lagging</p> <p><b>Charge Power Factor</b> [0.500 - 1.000]</p> <p>1.000 Lagging</p> </div> <div style="width: 40%;"> <p><b>DC Shutdown</b></p> <p><b>Battery 0% Load</b> [19.8 - 24.0 V]</p> <p>22.9</p> <p><b>Battery 100% Load</b> [19.8 - 24.0 V]</p> <p>20.4</p> <p><b>Recovery Voltage</b> [22.8 - 26.4 V]</p> <p>24.0</p> <p><b>SoC Shutdown</b></p> <p>Enabled</p> <p><b>Shutdown SoC</b> [0 - 100 %]</p> <p>30</p> </div> </div>								

With **Econo Mode** disabled the inverter will run continuously regardless of the AC load. When Enabled, the SP PRO will go to “sleep” when the AC load power is below the **Econo Transition Level** for more than 30 seconds. It will “wake up” again and run the load once the AC load goes above the **Econo Transition level**.

Once the SP PRO is running (A long press of the ON button on the front panel of the SP PRO and the ON LED is solid green) and the **Econo Mode** is Enabled, then a short push of the ON button will turn on **Econo Mode** which is indicated by the ON LED slowly flashing Green. A subsequent press of the ON button will turn off **Econo Mode**.

**Econo Transition level** is normally chosen to reflect the smallest load that is required to start the inverter, i.e. You may choose 20 watts if you want the inverter to start when you switch on a lamp or you may choose 5 -7 watts if you want it to turn on with a ‘phone charger’.

In **Econo Mode** the inverter puts out pulses of power (100mS wide) to sense the load power. The frequency of these pulses is adjusted by setting the **Econo Pulse Period**. e.g. If set to 0.5 s, the SP PRO will output a pulse every 0.5 seconds



ECONO MODE can only be enabled for single phase, DC coupled Off Grid configurations of 24 V and 48 V models. This feature is disabled for all other configurations including managed or generic AC coupled solar. If you have loads that require power 24/7, DO NOT enable Econo mode.

INVERTER OUTPUT sets the **Nominal AC Voltage** and the **Nominal AC Frequency** of the inverter. For example, in Australia this is 240 volts and 50 Hz.

When an SP PRO is being used in an “Solar Hybrid” application reference to the local grid supply voltage should be considered as this sometimes varies from the national standard. If unsure then consult the local power authority.

**Econo Power Save Mode**

**Econo Mode**

Disabled

**Econo Transition Level**  
[5 - 50 W]

10

**Econo Pulse Period**  
[0.2 - 1 s]

0.5

**Inverter Output**

**Nominal AC Voltage**  
[210 - 240 V]

240

**Nominal AC Frequency**

50 Hz



**Nominal AC Frequency** is set to 50Hz and cannot be changed when Powador Managed AC Coupled Solar is enabled. When ABB managed AC coupling or Fronius Managed AC coupling is enabled, then 50Hz or 60 Hz may be selected

**Support Power Factor.** This setting is configured when the SP PRO is installed as a Solar Hybrid (grid connected) system and the inverter is required by the Utility to provide support power at a non-unity power factor. Set the value of the required power factor and the phase of that power factor. Whenever the SP PRO is supporting the load from the battery, the supplied support power has a constant power factor according to this setting

**Charge Power Factor.** This parameter sets the power factor of the power being taken from the AC source when the SP PRO is charging the battery bank. Unless there is a special design requirement for this setting it is always left at 1.000.

NOTE: The Power factor setting for Support Power Factor and Charge Power Factor is from the Networks perspective.

**Support Power Factor**  
[0.500 - 1.000]

1.000  Lagging

**Charge Power Factor**  
[0.500 - 1.000]

1.000  Lagging

DC SHUTDOWN uses battery voltage to control how far the batteries will discharge before the inverter will switch itself off. These settings are important as discharging batteries too far can make them hard to recharge or even damage the batteries.

The first setting **Battery 0% Load** is the voltage at which the inverter will shutdown with no load applied to the battery including any DC loads. The second setting **Battery 100% Load** is the shutdown voltage when 100% battery load is applied. 100% battery load is when the battery current is equal to 20% of the battery capacity (C/5). When the battery load is between these two levels the SP PRO will calculate a shutdown voltage based on these two voltages.

Battery load is only the energy coming from the battery. As an example, in an AC Coupled system with no AC source, 2 kW of AC Load and 2 kW of solar there will be NO load on the battery so the DC shutdown will be at the **Battery 0% Load** voltage .

**Recovery Voltage** When the inverter shuts down due to low voltage this setting allows you to determine the voltage at which the inverter will start up again. It is wise to make this voltage high enough to ensure that sufficient recharging has occurred before the inverter turns on again.

DC Shutdown

**Battery 0% Load**  
[39.6 - 48.0 V]

**Battery 100% Load**  
[39.6 - 48.0 V]

**Recovery Voltage**  
[45.6 - 52.8 V]

**SoC Shutdown.**(Only available when SoC Control is Enabled) Programs the inverter to shutdown in response to the state of charge of the battery. When enabled the **Shutdown SoC** can be set anywhere between 0 and 100%. For a lead acid battery this will generally be 40-60% but confirm this with the battery supplier.

In a well designed Off Grid system the batteries should only get to the Shutdown State Of Charge during a fault condition (e.g. Generator failed to start).

For a well designed Solar Hybrid (On Grid) system the Shutdown SoC would only be reached during a grid outage.

The **Shutdown SoC** setting also determines the lowest reading (one LED on) of battery indicator display on the front panel of the SP PRO.

**SoC Shutdown**

Disabled

**Shutdown SoC**  
[0 - 100 %]



## Battery Settings

The Battery Tab contains settings intended to protect and maintain the batteries. Please note that you must comply with the requirements of the batteries specifications, failure to do so may void the battery warranty. When in doubt, consult the battery supplier.

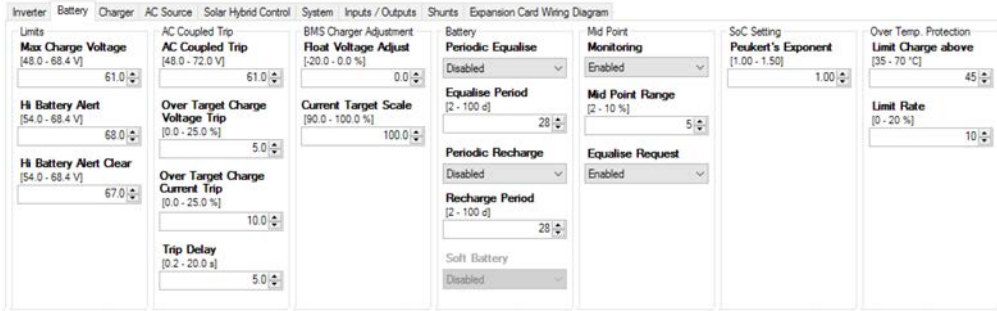

**Max Voltage Limit** is the absolute maximum voltage produced by the charging section of the inverter in any charge stage.

**Hi Battery Alert** initiates an alarm when the battery voltage exceeds this level.

When either “Generic AC Coupling” or “String Inverter” has been set (in System tab. See page 24) this setting has an additional protection function. When the Hi Battery Alert voltage has been exceeded for a few seconds indicating a fault in the AC coupled installation, the SP PRO will ramp the frequency of its AC output to 55Hz to disconnect all connected AC coupled grid inverters thereby removing all AC coupled charging sources.

When the battery voltage falls to the value set in **Hi Battery Alert Clear** the alarm stops.

**AC Coupled Trip** is the battery voltage at which the SP PRO will trip any Managed AC coupled Solar to zero output. This is a legacy setting and is not used in firmware versions greater than 9.09. This is replaced by the **Over Target Charge Voltage Trip** setting.

**Over Target Charge Voltage Trip** is the percentage over the battery charge target voltage at which the SP PRO will trip any Managed AC coupled Solar to zero output. This setting is used for Lithium battery or similar technologies that have an absolute maximum battery charge voltage.

**Over Target Charge Current Trip** is the percentage over the battery charge target current at which the SP PRO will trip any Managed AC coupled Solar to zero output. This setting is used for Lithium battery or similar technologies that have an absolute maximum battery charge current.

**Trip Delay.** When the charge voltage or the charge current exceeds the **Over Target Charge Voltage Trip** or **Over Target Charge Current Trip** respectively for this time, then any Managed AC coupled Solar will trip to zero output. These settings are used for Lithium battery or similar technologies that have an absolute maximum battery charge voltage or current.

**Float Voltage Adjust** Only functional when a BMS is used. Some lithium batteries need to have the charge target voltage reduce slightly when the battery reaches full charge. This is to prevent over charging the battery bank and tripping the BMS shutdown.

**Current Target Scale** Only functional when a BMS is used. Scales the BMS target charge current to account for any calibration errors in the battery BMS. Particularly useful when the shutdown function in the BMS does not tolerate even the slightest over target charge current.

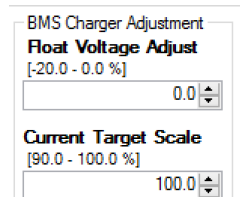
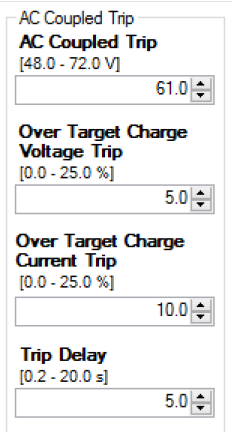
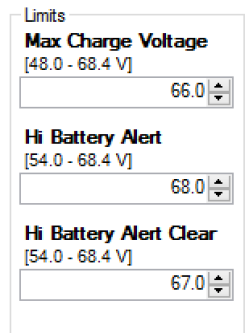



**Periodic Equalise.** Battery banks used in cyclic applications may, over time develop charge (and voltage) imbalances and may require an “equalise” charge . How often an equalise occurs is set using **Equalise Period**. The equalise charge voltage, current and duration are set in the CHARGER tab. (See “Charger Settings” section)

When an equalise charge is carried out by a charging source that is external to the SP PRO (i.e. DC coupled solar or wind sources) the SP PRO monitors this and reschedules its equalise. For the SP PRO to reschedule, the battery voltage must be taken to or above the EQUALISE STAGE voltage for the EQUALISE TIME settings in the SP PRO therefore it is important to match or slightly exceed these setting in the external renewable controller.

**Periodic Recharge** is for systems that remain on Float charge for long periods of time such as Solar Hybrid or Boats in Marinas. Battery banks operating in these conditions benefit from periodically being put through a full charge process. When enabled, after remaining in Float for the number of days set by the **Recharge Period**, the SP PRO will return to Initial charge stage.

**Soft Battery** setting is only available when Custom Battery Type is selected and is for battery banks that are “soft” meaning they have a relatively high internal impedance. Useful with aqueous type battery technologies or battery banks with high internal impedance. Technically this function is achieved within the SP PRO by reducing the gain of the battery charger’s voltage control loop thereby increasing the damping of said loop. Settings are Softness 1 to Softness 6 with Softness 6 being the “softest” setting. NOTE: This setting is only effective with battery technologies that have an inherently high internal impedance such as aqueous type technologies. Using this setting with serviceable lead acid or lithium battery technologies may cause unintended charger operation and in some cases over voltage shutdowns.

**Mid Point Monitoring** is a function designed to highlight any significant voltage variation between one half of the battery bank and the other. If one half of the bank is lower than the other it may suggest that the batteries need an equalisation charge or, perhaps, that there is a cell in one half that is not performing correctly. In **Mid Point Range** you determine how much variation between the two halves you will allow before notification. With this function you can help predict battery problems. To make use of this feature you will need to install an additional wire to the battery, see installation section for details. We recommend the use of this handy feature.

Often these problems can be solved by an equalisation charge so we have included provision for you to request such a charge by enabling the **Equalise Request** setting.

**Peukert’s Exponent** is a legacy setting and is not required in SP PRO firmware versions 7.06 and greater. The firmware now intelligently learns and compensates for the battery performance resulting in a more accurate SoC calculation.

**OVER TEMP. PROTECTION** This feature reduces the charge current automatically as the battery temperature rises above the temperature specified in **Limit Charge above**. It reduces the charge current by the **Limit Rate** for every degree Celsius that the temperature is above the temperature specified.

With the default settings the charge rate will drop 10% for every degree over 45°C. e.g. no charging current at 55°C.

Battery

**Periodic Equalise**

Enabled

**Equalise Period**  
[2 - 100 d]

28

**Periodic Recharge**

Disabled

**Recharge Period**  
[2 - 100 d]

28

**Soft Battery**

Disabled

Mid Point

**Monitoring**

Disabled

**Mid Point Range**  
[2 - 10 %]

5

**Equalise Request**

Enabled

SoC Setting

**Peukert's Exponent**  
[1.00 - 1.50]

1.15

Over Temp. Protection

**Limit Charge above**  
[35 - 70 °C]

45

**Limit Rate**  
[0 - 20 %]

10





## Charger Settings

This tab shows all the settings relating to the DC voltages and currents used in the battery recharge stages.

The normal charge cycle involves a four stage charge – Initial, Bulk, Absorption and Float– while periodically it is necessary to go one stage further, for the performance and longevity of the battery bank, to the Equalise stage. We will describe each of these stages as we progress. Please note there is a slider at the bottom of this page to move to more settings as this section is quite extensive.

Charge Settings	Initial Stage	Bulk Stage	Absorption Stage	Absorb-Float Transition
<b>Max. Charge Current</b> (as % of Battery Capacity) [1 - 100 %] 25   156 A	<b>Voltage</b> [48.0 - 60.0 V] 55.2	<b>Voltage</b> [48.0 - 60.0 V] 56.4	<b>Voltage</b> [48.0 - 62.4 V] 57.6	<b>Net Change</b> (as % of Battery Capacity) 0.1 - 5.0 % 1.0
<b>Initial Return</b> [45.6 V - Float V] 50.4	<b>Current</b> (as % of Max Chrg Current) [1 - 100 %] 100   156 A	<b>Current</b> (as % of Max Chrg Current) [1 - 100 %] 80   125 A	<b>Current</b> (as % of Max Chrg Current) [1 - 100 %] 60   94 A	<b>Change Time</b> [1 - 240 min] 30
	<b>Time</b> [1 - 240 min] 5	<b>Time</b> [1 - 240 min] 10		<b>Max Time</b> [1 - 240 min] 120



The default charge settings should be considered as safe for most battery types. Exact charging parameters should be confirmed with the battery supplier.

**Max. Charge Current** is the maximum charge current that the inverter will allow to the batteries under any circumstances (including all external charge currents) at any charge stage. This is expressed as a percentage of the battery capacity. For example if the battery capacity is 900 amp hours and the battery manufacturer suggests a maximum charge current of 10% of capacity then you would set this figure at 10% and the maximum charge current limit would be set at 90 amps. If, in this case there is 40 A of solar charge current, the inverter will add to this a maximum of 50 A of charge into the battery.

**Initial Return** is the voltage level at which the charge cycle will return to the beginning, or Initial, stage of the charge process. The battery voltage must remain at or below this level for 2 minutes to switch to Initial. This ensures that short term loads do not prematurely cause the charger to reset to Initial. The setting will turn RED when it exceeds the lowest float voltage (either Float or Long term Float) minus 5% for Lead Acid or 2% for Lithium or Custom Battery Types. Care should be taken when setting in the RED region to ensure the Float or Long term Float voltages cannot trigger the Initial return under the maximum battery temperature conditions.

The Charge cycle will also revert to the INITIAL stage when the battery SoC drops below 95%. This is to ensure the charger will still initialise under light battery loads that do not take the battery voltage below the Initial return voltage.

**INITIAL STAGE:** The purpose of the INITIAL STAGE of the charging process is to raise the battery voltage quickly with a large charge current. In this section you set the **Voltage** you wish the batteries to reach, the **Current** you wish to charge at and the length of **Time** the batteries will stay at that voltage until the inverter moves to the next stage of the charge cycle.

The current is expressed as a % of the maximum charge current. Using our previous example if the maximum charge current was 90 amps and you wish to charge, in this stage, at ~85 amps you would insert 95 in this area. i.e. 95% of 90 amps = 85.5 amps

Charge Settings  
**Max. Charge Current**  
(as % of Battery Capacity)  
[1 - 100 %]  
25 | 156 A  
**Initial Return**  
[45.6 V - Float V]  
50.4

Initial Stage  
**Voltage**  
[48.0 - 60.0 V]  
55.2  
**Current**  
(as % of Max Chrg Current)  
[1 - 100 %]  
100 | 156 A  
**Time**  
[1 - 240 min]  
5



BULK STAGE is the part of the charge cycle where the majority of the charging takes place. This is normally set at a higher **Voltage** than the initial stage but at a lower charge **Current**. The **Time** setting determines, once the Bulk **Voltage** is reached, how long the batteries stay at this level until the inverter starts the next stage of the charge process.

Once again using our example if you wanted this stage to charge at ~80 amps you would insert 90 as the setting because 90% of 90 amps is 81 amps. The time that the charge stage would remain at this voltage would normally be set longer than in the initial stage.

**Bulk Stage**  
**Voltage**  
 [48.0 - 60.0 V]  
 56.4  
**Current**  
 (as % of Max Chrg Current)  
 [1 - 100 %]  
 80 125 A  
**Time**  
 [1 - 240 min]  
 10

ABSORPTION STAGE is the part of the charge process that allows the batteries to maximise the effect of the previous charge stages. This stage is normally set to a higher **Voltage** than the two previous stages but a lower charge **Current**. The **Max Time** it would remain in this stage is longer again than the previous stages.

This section has a further level of control in that it will also end this stage and transition to Float if the change in current becomes less than the **Net Change** setting for a period equal to the **Change Time** setting. NOTE: When "System SoC" shunt is configured (see Shunt Settings) then the current measured by this shunt type is used for the change in **Net Charge**.

**Note:** SoC will be set to 100% when Float Charging Mode is entered.

For example if you have set the absorption VOLTAGE to 57.6 volts, the CURRENT to 60% (54 amps) and the MAX TIME to 120 minutes, then the battery will be charged at 54 A until the battery voltage reaches 57.6 volts. At this point the battery charging stage will change from Absorption into Float based on which of the following occurs first:

1. The rate of change in charge current is low. For example the battery bank capacity is 900 Ah, NET CHANGE is set to 1% and CHANGE TIME set to 30 minutes. Transition to Float will occur when net battery charge current has not changed by more than 9 A in 30 minutes.
2. The MAX TIME has expired. This is the maximum time the charger will stay in the Absorption stage after the battery voltage has reached the VOLTAGE setting..

**Absorption Stage**  
**Voltage**  
 [48.0 - 62.4 V]  
 57.6  
**Current**  
 (as % of Max Chrg Current)  
 [1 - 100 %]  
 60 94 A

**Absorb-Float Transition**  
**Net Change**  
 (as % of Battery Capacity)  
 0.1 - 5.0 %  
 1.0  
**Change Time**  
 [1 - 240 min]  
 30  
**Max Time**  
 [1 - 240 min]  
 120

In addition to these stages of charge there are more settings you can access by moving the bottom slider bar.

The screenshot shows a configuration interface with tabs: Inverter, Battery, Charger, AC Source, Solar Hybrid Control, System, Inputs / Outputs, Shunts, Expansion Card, Wiring Diagram. The 'Charger' tab is active, showing settings for Absorption Stage, Absorb-Float Transition, Float Stage, Equalise Stage, and Battery Temperature Compensation. The Absorption Stage settings are: Voltage 57.6, Current 60 (94 A), Change Time 30, Max Time 120. The Absorb-Float Transition settings are: Net Change 1.0, Change Time 30, Max Time 120. The Float Stage settings are: Voltage 54.0, Current 20 (31 A), Long Term Voltage 53.4, Time 2.0. The Equalise Stage settings are: Voltage 58.8, Current 20 (31 A), Time 2.0. The Battery Temperature Compensation settings are: Reference Temp. A 25, Ref. A Temp. Co. -5.0, Reference Temp. B 30, Ref. B Temp. Co. -3.0, Min. Comp. Temp. 0, Max. Comp. Temp. 45.

FLOAT STAGE :After completion of the charge cycle the inverter will enter the FLOAT STAGE. This setting reflects a **Voltage** that the system will maintain, with a good state of charge, for a long period. If the generator continues to run past the absorption or equalise stage for any reason, such as maintaining a high load, the inverter will keep the batteries at the float stage **Voltage** – not exceeding the **Current** set – until the generator is shut off. When the generator or mains voltage is present for longer than 24 hours the charger will drop to the **Long Term Voltage** to maintain a good state of charge for the lowest charge current. This is particularly useful in boating marinas where shore power may be connected for long periods.

**Note:** SoC will be set to 100% when Float Charging Mode is entered.

**Float Stage**  
**Voltage**  
 [48.0 - 60.0 V]  
 54.0  
**Current**  
 (as % of Max Chrg Current)  
 [1 - 100 %]  
 20 31 A  
**Long Term Voltage**  
 [48.0 - 60.0 V]  
 53.4



THE EQUALISE STAGE is not employed every time the batteries are charged but is a periodic charge process that raises the battery **Voltage** above the normal voltage settings to a point where the batteries will, essentially be in a state of overcharge. This is necessary to overcome any variations in voltage between individual cells that occur naturally in a battery bank that is cycled between load and charge cycles. These variations can cause a drop in performance in the battery bank and must be “equalised”. In flooded cells this process is sometimes called “gassing”, that is when the batteries sound as if they are lightly boiling. In flooded cells this bubbling helps to circulate the electrolyte fluid within the cells.

The Equalise stage will raise battery voltage to the equalise **Voltage** level and maintain this voltage for the equalise **Time**. The equalise **Current** will not be exceeded. If using Sealed batteries, the EQUALISE STAGE may be at the same voltage as Absorption voltage but for a longer period of time. Check with the Battery supplier.

Equalise Stage

**Voltage**  
[48.0 - 64.8 V]

**Current**  
(as % of Max Chrg Current)  
[1 - 100 %]

**Time**  
[1.0 - 10.0 hours]

TEMPERATURE COMPENSATION: Most lead acid batteries require the charging voltages to change with temperature (Temperature Compensation). The temperature compensation between the **Min. Comp. Temp** and **Reference Temp. A** is set in the **Ref. A Temp. Co**. The temperature compensation between the **Max. Comp. Temp** and **Reference Temp. B** is set in the **Ref. B Temp. Co**.

The temperature compensation between the **Reference Temp A** and **Reference Temp. B** is zero and equals the charge voltage setting.

**Ref. A Temp. Co.** and **Ref. B Temp. Co** sets the charge voltage change in mV per deg C for each 2V cell .

For example using settings in the diagram to the right and assuming a 48V battery bank (24 cells) and a charging voltage target of 57.6V (absorption stage).

$$\text{Charge voltage at 10C} = 57.6 + ((10-25) \times -5.0 \times 24 / 1000) = 59.4V$$

$$\text{Charge voltage at 40C} = 57.6 + ((40-30) \times -3.0 \times 24 / 1000) = 56.88V$$

Charge voltage between 25C and 30C is 57.6V

For your reference the total voltage compensation per deg C for the battery pack is displayed.

Temperature compensation is set to zero and is not available when Lithium Batty Type is selected.

Battery Temperature Compensation

<b>Reference Temp. A</b> [-10 - <Ref B> °C] <input type="text" value="25"/>	<b>Ref. A Temp. Co.</b> [-10.0 - 0.0 mV/Cell/°C] <input type="text" value="-5.0"/> <input type="text" value="-0.12 V/°C"/>
<b>Reference Temp. B</b> [<Ref A> - 70 °C] <input type="text" value="30"/>	<b>Ref. B Temp. Co.</b> [-10.0 - 0.0 mV/Cell/°C] <input type="text" value="3.0"/> <input type="text" value="-0.072 V/°C"/>
<b>Min. Comp. Temp.</b> [-10 - <REF A> °C] <input type="text" value="0"/>	
<b>Max. Comp. Temp.</b> [<REF B> - 70 °C] <input type="text" value="45"/>	

## AC Source Settings

The next tab in our settings menu is the AC Source tab. In this section we are able to change important settings relating to either the generator or the mains voltage. We use the words AC Source rather than Generator or Grid power as the SP PRO can be used in a variety of applications which include either of those AC supplies.

There are four sub-tabs within this section:

- AC INPUT, relates to general settings that apply if either a generator or the mains grid are used as input power.
- GENERATOR AUTO START relates to conditions that will start the generator automatically.
- GENERATOR SCHEDULE START allows programming of scheduled run times for the system.
- GENERATOR CONTROLLER SETTINGS is used to set up parameters that relate to the motor generator.

## AC Input

This tab allows you to change the conditions under which the AC Input will be utilised by the SP PRO and transferred through to the AC Load.

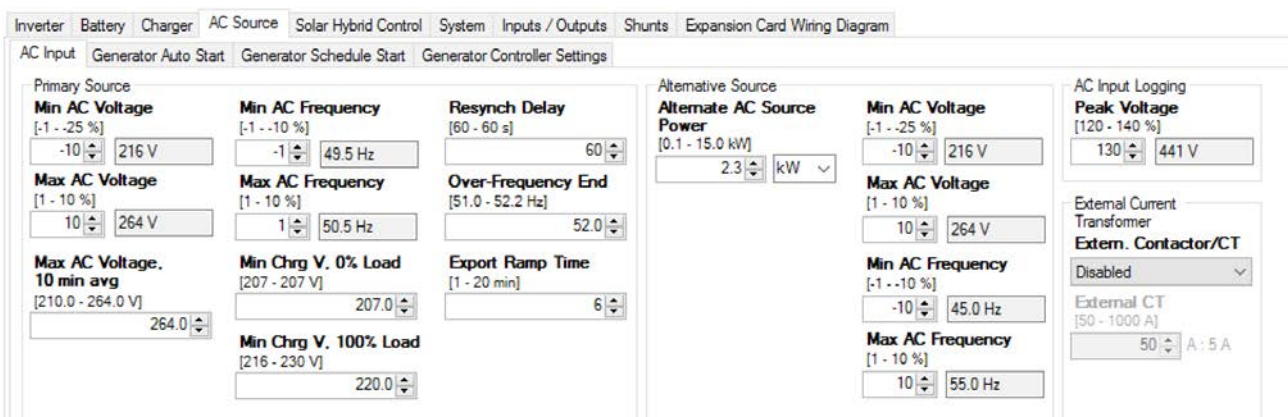

The screenshot shows the 'AC Source' configuration window with the following settings:

Parameter	Value
Primary Source Min AC Voltage	-10% (216 V)
Primary Source Max AC Voltage	10% (264 V)
Primary Source Max AC Voltage, 10 min avg	264.0 V
Primary Source Min AC Frequency	-1% (49.5 Hz)
Primary Source Max AC Frequency	1% (50.5 Hz)
Primary Source Min Chrg V, 0% Load	207.0 V
Primary Source Min Chrg V, 100% Load	220.0 V
Resynch Delay	60 s
Over-Frequency End	52.0 Hz
Export Ramp Time	6 min
Alternate AC Source Power	2.3 kW
Alternate AC Source Min AC Voltage	-10% (216 V)
Alternate AC Source Max AC Voltage	10% (264 V)
Alternate AC Source Min AC Frequency	-10% (45.0 Hz)
Alternate AC Source Max AC Frequency	10% (55.0 Hz)
AC Input Logging Peak Voltage	130 (441 V)
External CT	50 A : 5 A

THE PRIMARY SOURCE configurations set the AC voltage and frequency at which the AC source will disconnect, when an export power limit occurs or when the charge power taken from the AC Source is limited.

**Min AC Voltage AND Max AC Voltage.** These parameters are set as a percentage of the Nominal AC Voltage setting (under the Inverter tab). If the AC source voltage goes outside these limits the SP PRO will disconnect from the AC Source. The defaults (as shown) are for Australia and NZ.

**Min AC Frequency AND Max AC Frequency.** The parameters are set as a percentage of the Nominal AC Frequency setting (under the Inverter tab). If the AC source frequency goes outside these limits the SP PRO will immediately disconnect from the AC Source. The defaults (as shown) are for Australia. For NZ, set the Min AC Frequency to -10 (45Hz).

**Max AC Voltage, 10 min avg.** This setting is only used in a Solar Hybrid system. For off grid systems set it to the maximum value of 264V. If the 10 minute average of AC Source Voltage goes above this value then the SP PRO will disconnect from the AC source. The default of 255V is suitable for Australia. Set this to 248V for New Zealand.

**Min Chrg V 100%.and Min Chrg V 0%** These setting are used in Solar Hybrid systems to reduce the charge power from the grid when the voltage is low. The charge power taken from the AC source reduces linearly as its voltage drops below Min Chrg V 100%, reaching zero at or below the Min Chrg V 0%. The defaults as shown are for Australia and NZ.

**Reconnect Delay** In a Solar Hybrid Load system, the time the AC source is in tolerance before re connecting to the grid. This delay does not apply to off grid or mobile systems. The defaults as shown are for Australia and NZ.

**Over-Frequency end** In a Solar Hybrid system the export power is reduced with over frequency of the grid. This setting is the grid frequency at which the export power reaches zero. The defaults as shown are for Australia and NZ.

**Export Ramp time** In a Solar Hybrid system, the time it takes the export power to ramp up to full power after a grid connection or re-connection. The defaults as shown are for Australia and NZ.



For off grid systems, these limits are important because allowing higher voltages from a generator may shorten the life of appliances; while allowing low voltage and frequency from a generator may overheat or overstress motors. The quality of supply to the load will be better with tighter settings, however this will also cause the inverter to disconnect from the AC Source and power the load from battery supply more often.

For Solar Hybrid systems, these settings need to align with the requirements of the local grid connect standards. The default settings are suitable for the Australian grid. For the New Zealand grid, **Min AC Frequency** and **Max AC Voltage, 10 min average** need to be changed to -10 and 248 respectively.

ALTERNATIVE SOURCE. Configuration settings are used in place of the PRIMARY SOURCE settings and the AC Source Power setting (in Quick Start section). The SP PRO uses these settings when running a backup generator in a Solar Hybrid system, a second generator in an Off Grid system or shore power in a mobile installation.

The Alternative Source is selected when the configured digital input is active. The digital input is configured using the Normal/Alternate Input Power Selector parameter in the Inputs/Outputs section.

If a backup generator is required in a Solar Hybrid (On Grid) system, the optional Grid Fail Generator Backup Module will need to be installed.

**Alternate AC Source Power** sets the capacity of the Alternative AC Source. If the alternative AC source is a generator then set this to its continuous power rating. If the Alternative AC source is shore power then set this to the rating of the shore power outlet.

**Min AC Voltage** AND **Max AC Voltage**. These parameters are set as a percentage of the Nominal AC Voltage setting (under the Inverter tab). If the AC source voltage goes outside these limits the SP PRO will immediately disconnect from the AC Source.

**Min AC Frequency** AND **Max AC Frequency**. The parameters are set as a percentage of the Nominal AC Frequency setting (under the Inverter tab). If the AC source frequency goes outside these limits the SP PRO will immediately disconnect from the AC Source.

**Extern. Contactor/CT**. If a pass through current of greater than 63A AC (125A AC SPLC1200 and SPLC1202) is required then this setting is enabled when an external contactor and current transformer of up to 1000AAC is installed. The current rating of the external current transformer is entered in **External CT**.

See separate Installation instructions TN0057 available from the web site under the Support tab.

The AC INPUT LOGGING is a Quality of Service monitoring function which sets the **Peak Voltage** threshold at which the inverter will record a performance data event. (Peak Voltage of AC rather than RMS - 240V AC has a peak voltage of 340 V)

If you have particularly sensitive loads such as computers and plasma TVs, you may choose to set this to a low value to monitor power quality and record any unexpected high voltages coming from external supply sources.

Alternative Source

**Alternate AC Source Power**  
[0.4 - 217.4 A]

9.6 A

**Min AC Voltage**  
[-1 - -30 %]  
-10 216 V

**Max AC Voltage**  
[1 - 10 %]  
10 264 V

**Min AC Frequency**  
[-1 - -10 %]  
-10 45.0 Hz

**Max AC Frequency**  
[1 - 10 %]  
10 55.0 Hz

External Current Transformer

**Extern. Contactor/CT**  
Disabled

**External CT**  
[50 - 1000 A]  
50 A : 5 A

AC Input Logging

**Peak Voltage**  
[120 - 140 %]  
130 441 V

## Generator Auto Start

The use of an auto start generator in an Off Grid system is essential as a backup energy source in times of poor Renewable Energy production. In an Solar Hybrid (ON Grid) system the installation of an auto start generator can also provide excellent backup in times of extended outages without the need for oversized battery bank. This section explains how to use the generator to maximise battery life whilst obtaining the lowest operating costs on the system. The Generator Auto Start tab enables you to change the conditions under which the generator will start and stop. When a generator is started it will give first priority to service the AC Loads and any leftover available generator capacity will be used to charge the batteries.

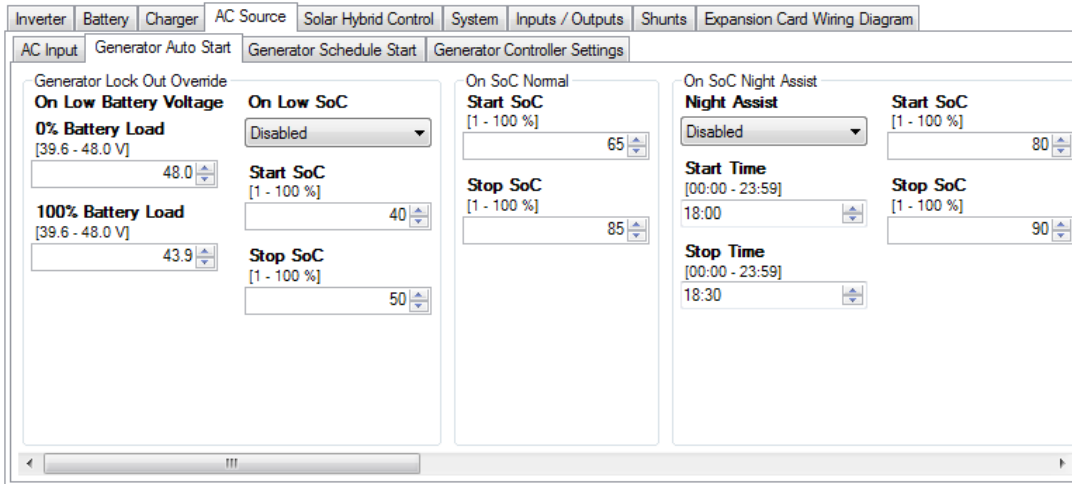

The screenshot shows the 'Generator Auto Start' configuration window. It includes tabs for 'AC Input', 'Generator Auto Start', 'Generator Schedule Start', and 'Generator Controller Settings'. The 'Generator Auto Start' tab is active, showing settings for 'Generator Lock Out Override', 'On Low Battery Voltage', 'On Low SoC', 'On SoC Normal', and 'On SoC Night Assist'. The 'On Low Battery Voltage' section has '0% Battery Load' at 48.0V and '100% Battery Load' at 43.9V. The 'On Low SoC' section has 'Start SoC' at 40% and 'Stop SoC' at 50%. The 'On SoC Normal' section has 'Start SoC' at 65% and 'Stop SoC' at 85%. The 'On SoC Night Assist' section has 'Night Assist' set to 'Disabled', 'Start Time' at 18:00, and 'Stop Time' at 18:30. 'Start SoC' is 80% and 'Stop SoC' is 90%.

### GENERATOR LOCK OUT OVERRIDE

**On Low Battery Voltage:** As a safety net the SP PRO will always start the generator based on battery voltage, regardless of the battery SoC or the status of the Generator Lockout. When the battery voltage drops below the **On Low Battery Voltage** settings, the generator will start and run for the Minimum Run Time.

**On Low SoC:** When the **On Low SoC** is enabled and the state of charge falls below **Start SoC** at any time during the GENERATOR LOCK OUT period the generator will start and run until the SoC reaches **Stop SoC** or at the least for the Generator Minimum Run time.

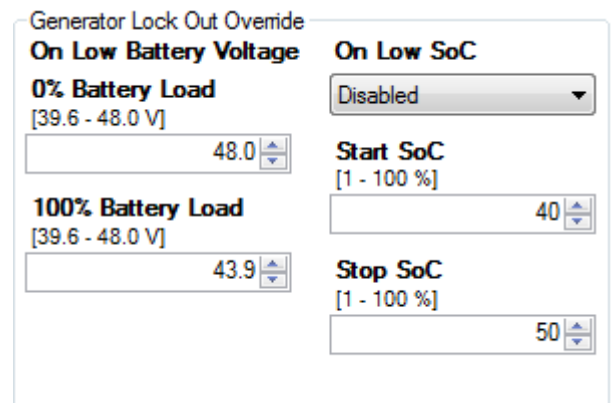

This close-up shows the 'Generator Lock Out Override' section. It includes 'On Low Battery Voltage' with '0% Battery Load' at 48.0V and '100% Battery Load' at 43.9V. The 'On Low SoC' section has a dropdown menu set to 'Disabled', 'Start SoC' at 40%, and 'Stop SoC' at 50%.

The ON SoC NORMAL setting applies at times other than when other SoC Start Stop functions are active including during Generator Lock Out times. If SoC falls below **Start SoC%** the generator will be started and will charge until **Stop SoC%** or for Generator Minimum Runtime if **Stop SoC%** is reached before the minimum runtime has elapsed. By not allowing the generator to take the batteries to 100% avoids the generator from being too lightly loaded as batteries become full. It is more efficient to allow Renewable sources to fill the batteries to 100%

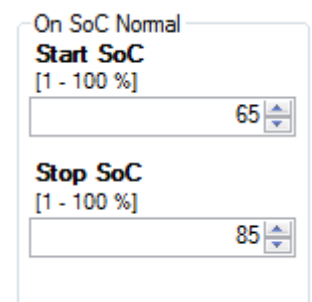

This close-up shows the 'On SoC Normal' section. It includes 'Start SoC' at 65% and 'Stop SoC' at 85%.



The ON SoC NIGHT ASSIST state of charge control monitors the State of Charge through the highest usage period, usually during the evening. If the battery level has dropped to the **Start SoC** level at the appointed time (between the **Start Time** and the **Stop Time**) the SP PRO will start the generator and raise the state of charge until the batteries reach the **Stop SoC** level. This prepares the system for the night ahead.

On SoC Night Assist

**Night Assist**  
Disabled

**Start SoC**  
[1 - 100 %]  
80

**Start Time**  
[00:00 - 23:59]  
18:00

**Stop SoC**  
[1 - 100 %]  
90

**Stop Time**  
[00:00 - 23:59]  
18:30

By moving the bottom slider to the right you can access more settings in this field.

ON SoC RENEWABLE PREFERRED is designed to monitor the input from the solar array and, on a day when the renewable sources may be low in output, on a cloudy day or a day with no wind, start the generator at a lower state of charge to ensure the batteries do not get too low. This setting allows you to set a **Start SoC** percentage and a **Stop SoC** percentage that will keep the batteries in a “safe” state of charge.

On SoC Renewable Preferred

**Renewable Preferred**  
Disabled

**Start SoC**  
[1 - 100 %]  
40

**Start Time**  
[00:00 - 23:59]  
07:00

**Stop SoC**  
[1 - 100 %]  
50

**Stop Time**  
[00:00 - 23:59]  
14:00

If the solar input does not meet the usual consumption level you can start the day with a compensating charge that will enable the normal solar input to fully charge the batteries.

The necessity for this charge can be worked out in conjunction with a Selectronic Accredited Integrator (Australia Only).

On SoC Renewable Assist

**Renewable Assist**  
Disabled

**Start SoC**  
[1 - 100 %]  
60

**Start Time**  
[00:00 - 23:59]  
07:00

**Stop SoC**  
[1 - 100 %]  
70

**Stop Time**  
[00:00 - 23:59]  
08:00



The combination of all these settings should give you a battery protection program that should look something like this.....

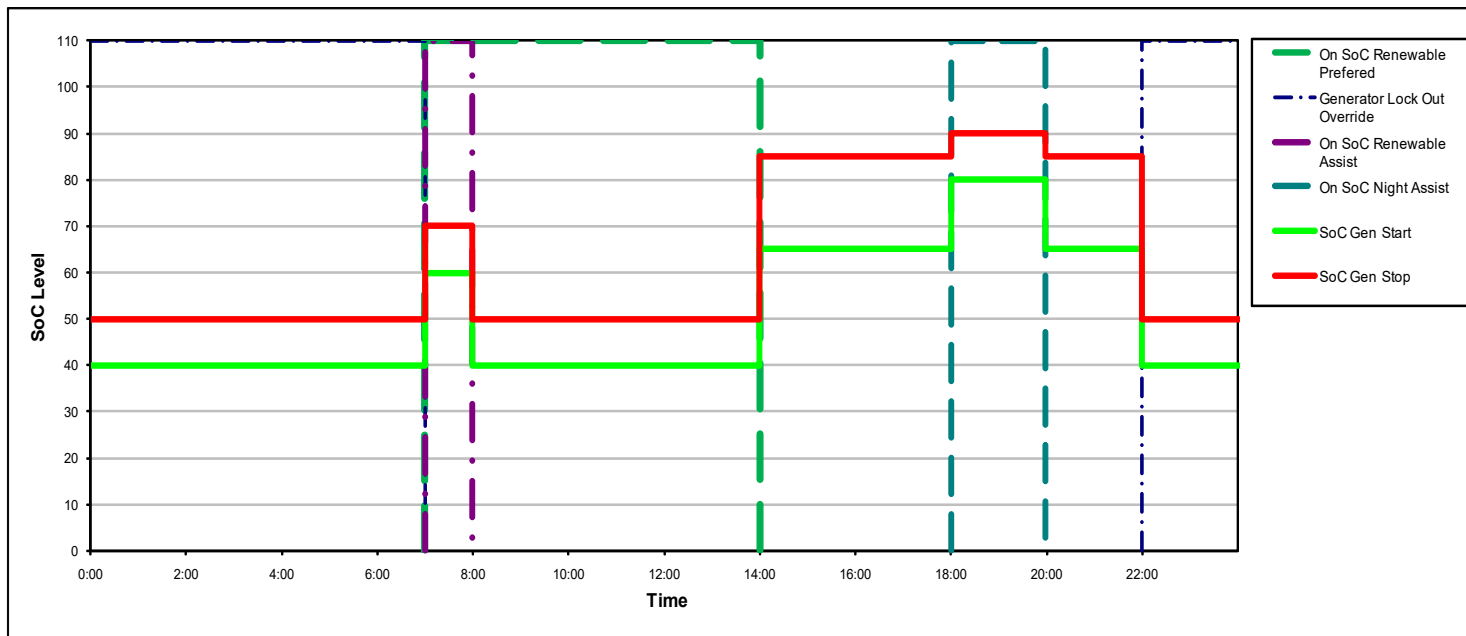

When you get up in the morning, before the solar panels are working at their best, the generator runs for an hour or so while you are cooking, or heating the bathroom for the kids, and starts the day with a support charge (see SoC Renewable Assist).

Then it shuts down during the day when you expect that the solar panels will be carrying the load; then it may start again later that night when the night load is at its highest or if there has been a cloudy day and there hasn't been as much solar input as you would have expected.

Throughout the whole day there is always the lower Generator Lockout Override "safety net" level that will not allow the batteries to get totally flat. A Selectronic Accredited Installer can help you arrive at the most fuel efficient program to suit your particular needs.

The above system of Generator Auto Start SoC Start and Stop levels prevents the generator from charging the battery bank during the batteries least energy efficient stage; the highest voltage with the least amount of absorbed amp hours. This reduces the generator run time, saving fuel.

This type of system is called Partial SoC control. A battery system will perform well in partial SoC conditions however it is desirable to periodically fully charge a battery bank and bring the SoC to 100% by allowing the charger to complete through to Float stage.

Referring to the section FOR 100% SoC, if **Override Stop SoC** is enabled then during the Normal or Night Assist times, the generator will continue to run and charge the batteries right through to Float stage. This will occur according to the **Occurs Every** setting. In this example it occurs every 7 days.

For 100% SoC  
**Override Stop SoC**  
Disabled  
**Occurs Every**  
[1 - 100 d]  
7





The generator will also start if there is a persistent load on the batteries. **Battery Load** sets the level at which the generator will be started if the average load exceeds the preset level for more than 5 minutes.

**Battery Load** is the actual power being drawn from the battery bank. For example, if say solar is providing all the power to the site load, then no power will be coming from the battery bank i.e. Battery Load is 0 kW and the generator won't be started.

On 15 min Load is similar to the previous screen except the settings take effect if the average load exceeds the preset **Battery Load** limit for more than 15 minutes.

We previously discussed mid point monitoring and its ability to help determine a battery fault. This screen allows you to choose if a mid point **Voltage Error** should start the generator. The generator will then perform a full charge of the battery bank and if equalise is enable will perform an equalise charge.

On 5min Load  
**5 Min Load**  
Disabled  
**Battery Load**  
[0.2 - 15.0kW]  
4.0

On 15min Load  
**15 Min Load**  
Disabled  
**Battery Load**  
[0.2 - 65.0 kW]  
3.0

On Mid Point  
**Voltage Error**  
Enabled

## Generator Schedule Start

Some people have predictable times when they require a generator to run, such as when a regular plant watering routine requires pumps to run, the program contains the ability to predetermine four different schedules.

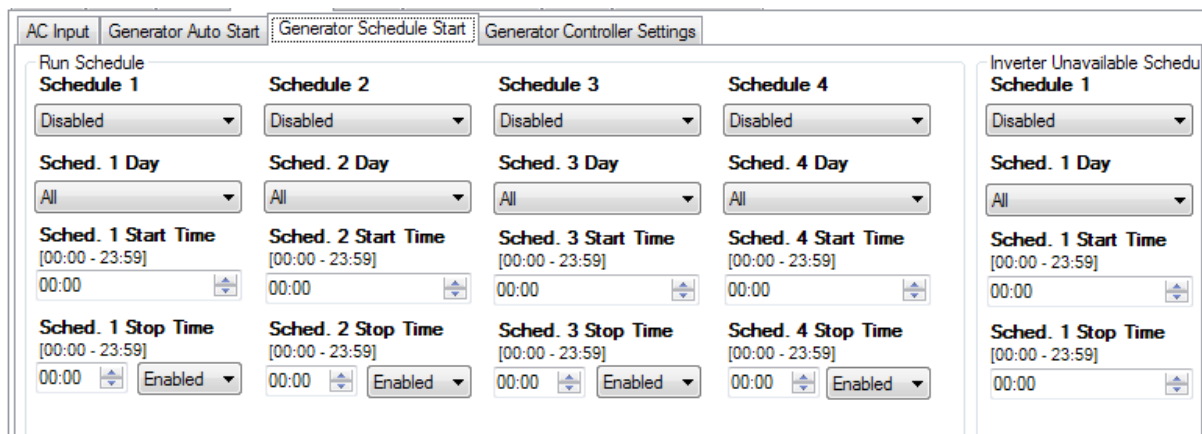

Each of the four Schedules (specified as Sched. x in the following examples) can be enabled or disabled.

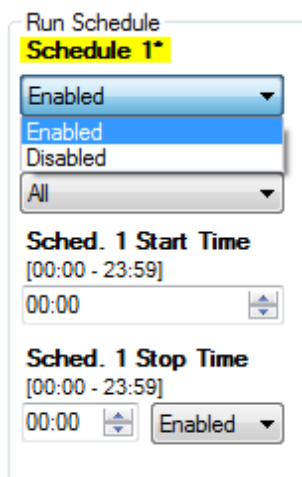

Using **Sched. x Day** you can choose a day of the week, all weekdays, all weekends or everyday (All).

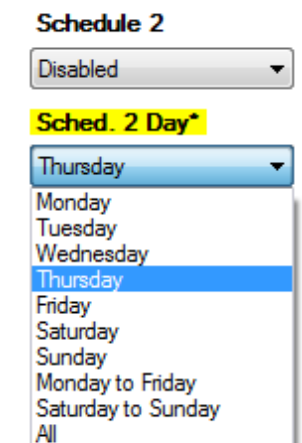



### A Sched. x Start Time

### And a Sched. x Stop Time

The **Sched. x Stop Time** can be enabled or disabled. If the stop time is enabled the SP PRO will automatically turn off the generator at the end of the scheduled time or, if disabled, the generator will continue to run if a full charge cycle has not been completed or until all other generator turn off criteria have been met.

As an example, lets imagine you run a yoga class every Saturday morning and you wish to run a reverse cycle air conditioner for the period of the lesson. You may choose to run the generator during this period to prevent stress on the batteries. In this case the schedule would look like this.

**Schedule 3**  
Disabled

**Sched. 3 Day**  
All

**Sched. 3 Start Time\***  
[00:00 - 23:59]  
05:00

**Sched. 3 Stop Time**  
[00:00 - 23:59]  
00:00 Enabled

**Schedule 4**  
Disabled

**Sched. 4 Day**  
All

**Sched. 4 Start Time**  
[00:00 - 23:59]  
00:00

**Sched. 4 Stop Time\***  
[00:00 - 23:59]  
22:00 Enabled  
Enabled  
Disabled

Run Schedule  
**Schedule 1\***  
Enabled

**Sched. 1 Day\***  
Saturday

**Sched. 1 Start Time\***  
[00:00 - 23:59]  
09:00

**Sched. 1 Stop Time\***  
[00:00 - 23:59]  
12:00 Enabled

By moving the slider to the right we find an INVERTER UNAVAILABLE SCHEDULE table. In the unlikely event that the SP PRO enters a shutdown condition whereby the inverter is unable to operate, the backup schedule can take effect in to start and stop the generator in addition to the existing Run Schedule. In the cases where the inverter is unable to operate, the AC Loads are powered directly from the generator via the built-in AC powered transfer contactor.

Inverter Unavailable Schedule			
Schedule 1	Schedule 2	Schedule 3	Schedule 4
Disabled	Disabled	Disabled	Disabled
Sched. 1 Day	Sched. 2 Day	Sched. 3 Day	Sched. 4 Day
All	All	All	All
Sched. 1 Start Time [00:00 - 23:59]	Sched. 2 Start Time [00:00 - 23:59]	Sched. 3 Start Time [00:00 - 23:59]	Sched. 4 Start Time [00:00 - 23:59]
00:00	00:00	00:00	00:00
Sched. 1 Stop Time [00:00 - 23:59]	Sched. 2 Stop Time [00:00 - 23:59]	Sched. 3 Stop Time [00:00 - 23:59]	Sched. 4 Stop Time [00:00 - 23:59]
00:00	00:00	00:00	00:00

A typical example would be to run a freezer four times a day, for two hours – every day, say with the first as an example from 6 am to 8 am. This function can minimise food loss and provide a safer environment until the inverter shutdown cause is determined. The size of the generator fuel tank should be considered in the design.

Inverter Unavailable Schedule
<b>Schedule 1*</b>
Enabled
Sched. 1 Day
All
<b>Sched. 1 Start Time*</b>
[00:00 - 23:59]
06:00
<b>Sched. 1 Stop Time*</b>
[00:00 - 23:59]
08:00



## Generator Control Settings

The last tab in the AC Source section is the Generator Controller Settings

If there is an automatic generator permanently connected to the system the **Generator Controller** setting should be set to Enabled. This is highly recommended for OFF Grid systems. If there is no automatic generator connected it should be Disabled.

The **Auto Start Available** control allows 2 states. Follow Input allows you to switch the generator availability on and off with an input signal (normally 12 volts from the generator). This ensures that the SP PRO will not try to start the generator if it has become unavailable, e.g. starter battery flat or generator maintenance is being performed. Assume Always allows the inverter to operate as if the generator is always available.

**Minimum Runtime** determines the shortest time the generator will run. This is to ensure the generator won't start and stop too frequently.

The **Pre-synchronised warm Up Time** is the length of time, after the generator starts, before the generator is connected (Transferred) to any load. This is then followed by the **Warm Up Time**, the length of time, after the **Pre-synchronised warm Up Time**, before a charging sequence starts. Once synchronised, the AC Load is transferred to the generator during the **Warm Up Time**. The staged warm up sequence allows the generator to circulate the oil within the motor thoroughly and to allow the motor to reach operating temperature before being heavily loaded by the charger.

**Cool Down Time** disconnects the load from a generator for a period of time before shutdown to allow turbochargers to cool down before switching off. The **Cool Down Time** is overridden if generator is stopped using front panel push button.

**Generator Lock Out** provides a "quiet time" when the generator will not run unless the batteries get to a dangerously low level ..low level as set in the Generator Lockout Override ("Generator Auto start" tab). This setting is generally used for overnight operation.

If the system design calls for very little, or infrequent generator input it is wise to run the generator periodically to keep the internal parts of the motor covered with oil and to keep the starting battery charged.

To use this feature Enable **Generator Exercise** and enter the **Start Time** the generator will run. **Max Days** determines how many days between generator starts. In this example the generator would start 30 days after the last time the generator was called for, would start at 18:00 and would run for the period set in Minimum Runtime.

Generator Exercise

**Generator Exercise**

Disabled ▾

**Start Time**  
[00:00 - 23:59]  
18:00 ▾

**Max Days**  
[1 - 100 d]  
30 ▾

**GENERATOR REMAIN ON.** This feature allows you to determine the minimum load will keep the generator running after a stop condition has been achieved, thus avoiding significant battery discharge. This term is expressed as a percentage of the inverter size. In this example the inverter size is a 6 kW and **AC Load (50 - 100%) of rating** is set to 80%. Therefore whilst the load on the system exceeds 4.8 kW (80% of 6kW) the generator will continue to run.

Generator Remain on

**AC load (50 - 100 %) of rating**  
[50 - 100 %]  
80 ▾

The **Start output Delay** setting determines the length of time after the generator run signal is initiated by the SP PRO, either by an external request, load requirement or by a battery charge requirement, before the generator start pulse is initiated.

**Start output Time** is the length of time a start pulse is sent. This output can be used in a pulse start/pulse stop type generator control.

**Confirm start time** is the time the SP PRO waits before deciding the generator hasn't started. The SP PRO will try a total of three times to get the generator running with a 60 second pause between each attempt.

Signal Timing

**Start Output Delay**  
[0.5 - 30.0 s]  
2.0 ▾

**Start Output Time**  
[0.5 - 30.0 s]  
2.0 ▾

**Confirm Start Time**  
[15 - 120 s]  
30 ▾

**SIGNAL TIMING GRAPH** The below graph depicts the relative timing for the Generator Run and the Generator Start signals.

When the generator is requested to start (A), the Generator Run signal is immediately asserted. After a delay equal to the **Start Output Delay** (A to B) the Generator Start signal is asserted (B) for a duration equal to the **Start Output Time** (B to C).

When the generator is requested to stop (D) the Generator Run signal is immediately de-asserted at the same time that the Generator Start signal is asserted for a duration equal to the **Start Output Time** (D to E).

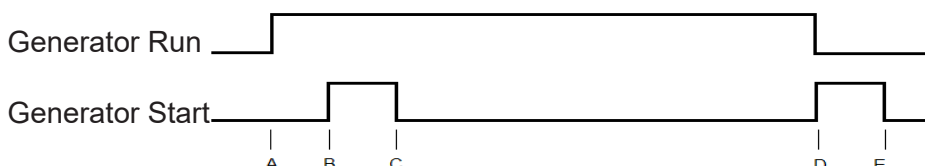



## Solar Hybrid Control Settings

The Solar Hybrid Control settings are enabled when the Unit Application is set to Solar Hybrid (On Grid) and SoC Control is Enabled. They allow the system designer to determine when a defined amount of stored battery energy is utilised in conjunction with the connected renewable energy sources to optimise their use. Optimum use of the renewable and stored battery energy gives the SP PRO control over when and the amount of grid energy, if any, is required to power the connected loads. Using the settings below provides this flexibility.

The screenshot shows the 'Solar Hybrid Control' configuration window. It features a tabbed interface with 'Solar Hybrid Control' selected. Below the tabs are eight priority levels (Priority 1 to Priority 8). The 'Date and Time Activation' section is expanded for Priority 1, showing 'Date Time Activation' set to 'Enabled', 'Day' set to 'All', and 'Begin Date' from '01 Jan' to '31 Dec' with 'Start Time' at '00:00' and 'Stop Time' at '23:59'. Other sections include 'Digital Control Activation', 'AC Source' (Grid Input Limit, Grid Export Limit, Grid Disconnect), 'Inverter Control' (AC Load Support Limit, SoC Support Limit, Inverter Shutdown), 'Charger Control' (Battery Charging, Restricted Charge Limit), 'Charger Override' (Battery Charging, Override Charge Limit, Start SoC, Stop SoC), and 'Power Override' (Inverter Target, AC Source limit during Override).

### PRIORITY 1 to PRIORITY 8

The Solar Hybrid Control is made up of eight groups of identical settings with each assigned and labelled a priority level from 1 to 8 with priority 1 being the highest. If two or more Priority Schedules are active at the same time, only the highest priority settings will apply.

When a Priority schedule is active, all of its configuration options are active during that time. To see what Priority group is active and the limits that currently apply, see the SYSTEM REGULATION STATUS under the DATA VIEW NOW display..

The following configuration options are common to all of the Priority schedules

ACTIVATION controls when the limits and controls set for that Priority schedule become operational. ACTIVATION is divided into two sections:-

**Enable Date and Time Activation** setting. Use **Begin Date** and **End Date** to set the inclusive date range over which you want this Priority Schedule to be active. By default the range is all year and only requires adjustment if part of a year such as summer is required.

**Day** selects the days of the week (Mon, Tues, ..., Sat-Sun, Mon-Fri, All) when the schedule to be active.

Select the **Start Time** and **Stop Time** (in 24 hr format) for the schedule to be active. If the **Stop Time** is earlier than the **Start Time** then the **Stop time** is for the following day. If the following day is not selected in the Day or Date setting then the schedule will stop at midnight on the last selected day.

This detailed view shows the 'Activation' section. The 'Enable Date Time Activation' dropdown is set to 'Enabled'. Under 'Active Dates', 'Begin Date' is '01 Jan' and 'End Date' is '31 Dec'. Under 'Active Time', 'Day' is 'All', 'Start Time' is '00:00', and 'Stop Time' is '23:59'.

The digital input set in **Activation Input** is also used to activate the Priority schedule. This input will activate the Priority schedule regardless of the Date Time Activation. When set to "Rising" the Priority will be active when the input is high and inactive when the input is low. A "Falling" setting will control the priority in the opposite sense..

Both Activation types (Date/time and Digital Control) can be used together remembering if one or the other is active then the Priority Schedule will be active.

During Activation, the output set in **Active Output** will be energised and can be used to signal other devices or to drive other inputs in the SP PRO.

This detailed view shows the 'Digital Control' section. 'Activation Input' is set to 'None', 'Activation Input Edge' is set to 'Rising', and 'Active Output' is set to 'None'.

AC SOURCE controls the grid connection in three ways:-

Set the **Grid Input Limit** to the maximum draw from the grid supply. This limit will override the AC Source Power limit configured within the Quick Start settings. Any AC Load demand above this limit will be supplied from the Battery plus renewable energy sources (Battery / RE system).

This limit will only be breached if the AC Load demands more power than is available from the Battery / RE system or if the SoC Support Limit within the Priority schedule is reached.

Set the **Grid Export Limit** to the maximum power to be put into the grid. This limit will override the AC Source Power limit configured within the Quick Start settings.

This limit only applies to Managed AC Coupling or DC Coupled PV and must be set to the maximum (15kW for SPMC models and 30kW for SPLC models) when using Generic AC Coupled supply.

Enable **Grid Disconnect** to switch the SP PRO into standalone mode and operate completely on the Battery plus any renewable energy generation. No grid export or grid battery recharge is possible when the **Grid Disconnect** is Enabled

The **Grid Disconnect** setting will be overridden if the SoC Support Limit within the Priority schedule is reached or if Inverter Disconnect is Enabled.

The **Grid Disconnect** setting will be disabled and greyed out in all secondary inverters in a multi phase configuration. Only the primary inverter controls this function.

AC Source

**Grid Input Limit**  
[0 - 217.4 A]  
 A

**Grid Export Limit**  
[0 - 217.4 A]  
 A

**Grid Disconnect**

INVERTER CONTROL manages the AC Load Battery Support by controlling the amount and limit of battery support.

**AC Load Support Limit** sets the maximum AC Load power that can be supported from the battery bank when the SP PRO is synchronised to the AC Source (Grid) supply. This power does not include any contribution from AC or DC Coupled PV.

This limit is overridden to zero when the SoC Support Limit is reached.

**SoC Support Limit** sets the minimum Battery SoC that the AC Load Support and AC Source control will operate to. When the **SoC Support Limit** is reached any discharge demand on the battery is diverted to the AC Source (Grid) supply. When the SoC recovers by 20% of the battery's discharge (e.g. back to 68% with a **SoC Support Limit** setting of 60%) then the **AC Load Support Limit** will once again apply.

Setting **Inverter Disconnect** to Enable switches the SP PRO into grid feed through mode and operate completely from the Grid and AC Coupled PV. No DC Coupled grid export, grid battery recharge or AC Load Support is possible during times when the **Inverter Disconnect** is Enabled.

The **Inverter Disconnect** setting will be overridden if the AC Source (Grid) supply falls outside AC voltage and frequency tolerance. There will be short break in supply (< 1.0 seconds) while the Inverter functions switches on-line to provide back-up power.

The **Inverter Disconnect** setting will be disabled and greyed out in all secondary inverters in a multi phase configuration. Only the primary inverter controls this function.

Inverter Control

**AC Load Support Limit, From Battery**  
[0 - 50 kW]  
 kW

**SoC Support Limit**  
[1 - 100 %]

**Inverter Disconnect**





CHARGER CONTROL restricts the total AC power level and all the AC sources (if any) from which the battery is being charged. The settings under Charger Control are active until the Battery SoC drops to the **Start SoC** setting under Charger Override, at which point the settings under Charger Override become active. The Charger Override settings will remain active until the battery SoC reaches the **Stop SoC** setting.

The settings below apply to both the Charger Control and the Charger Override.

**Battery Charging** sets the charging source. The three options are:-

**CHARGING ON:** The SP PRO will comply with the requirements of the “Charger” Settings unless they exceed the **Restricted Charge Limit** setting. If the rating of the inverter is less than the **Restricted Charge Limit** setting then the inverter’s rated charge power will apply. This will reduce as temperature of SP PRO increases. The Grid Input Limit setting can also affect the charge power as this cannot be exceeded when charging from the grid.

In summary the max charge power is the lesser of the following:

- The Charger settings limit.
- The **Restricted Charge Limit** setting
- The inverter Charge power rating (temperature dependent).
- Available power from all charging sources (Grid Input Limit –Load power + renewable Power).

The Charge Limit is displayed in the Data View > Now tab and is the lesser of:

- The **Restricted Charge Limit** setting
- The inverter Charge power rating (temperature dependent).

**RENEWABLE ONLY:** The SP PRO maximum charge power will be the lesser of the following limits.

- The Renewable Power available for charging = Renewable – Load power
- The Charger settings limit.
- The **Restricted Charge Limit** setting
- The inverter Charge power rating (temperature dependent).

The Charge Limit is displayed in the Data View > Now tab and is the lesser of:

- The Renewable Power available for charging = Renewable – Load power
- The **Restricted Charge Limit** setting
- The inverter Charge power rating (temperature dependent).

It should be noted that CHARGING ON setting with a Grid Input limit of 0kW operates the same as Renewable Only. This is because nothing can come from the grid during charging so charging can only come from renewable sources.

**CHARGING OFF:** Battery recharging disabled. This option will be overridden by any DC coupled solar charging sources when the AC Source (Grid) is disconnected or the Inverter is disconnected. It will be overridden by any Generic AC coupled sources when the AC Source (Grid) is disconnected.

CHARGER OVERRIDE settings become active instead of the Charger Control settings when the Battery SoC transitions down through the **Start SoC** setting. They revert back to the Charger Control settings when the Battery SoC transitions up through the **Stop SoC** setting. **Override Charge Limit** settings have the same function as the **Restricted Charge Limit** settings.

**AC Source limit during Override** allows an alternative AC source limit to be used when the battery Charging is in Charger Override.

Selecting **Grid Input Limit** (default value) means there will be no change to the AC Source Limit during Charger Override.

Selecting **AC Source Power** means that the AC Source Limit will change to the AC Source Power setting in the Quick Start section under the Configurations Settings tab.

POWER OVERRIDE has no function within standard SP PROs. Contact Selectronic for details.

Charger Control

**Battery Charging**

Charging On

**Restricted Charge Limit**  
[0 - 217.4 A]

208.3 A

System Regulation Status

Solar Hybrid Active

Priority 5

AC Source Input Limit  
0.00 kW

Grid Export Limit  
0.20 kW

Charge Limit  
1.50 kW

Charger Override

**Battery Charging**

Charging On

**Override Charge Limit**  
[0.0 - 15.0 kW]

15.0 kW

**Start SoC** [1 - 100 %]  
55

**Stop SoC** [1 - 100 %]  
70

**AC Source limit during Override**

Grid Input Limit

Power Override

**Inverter Target**  
[0 - 217.4 A]

0.0 A

## System Settings

In this section we will look at how the SP PRO works with the whole system. Whether the SP PRO will automatically recover from system faults, how it will alert you of problems and how it links with the computer and other communication devices.

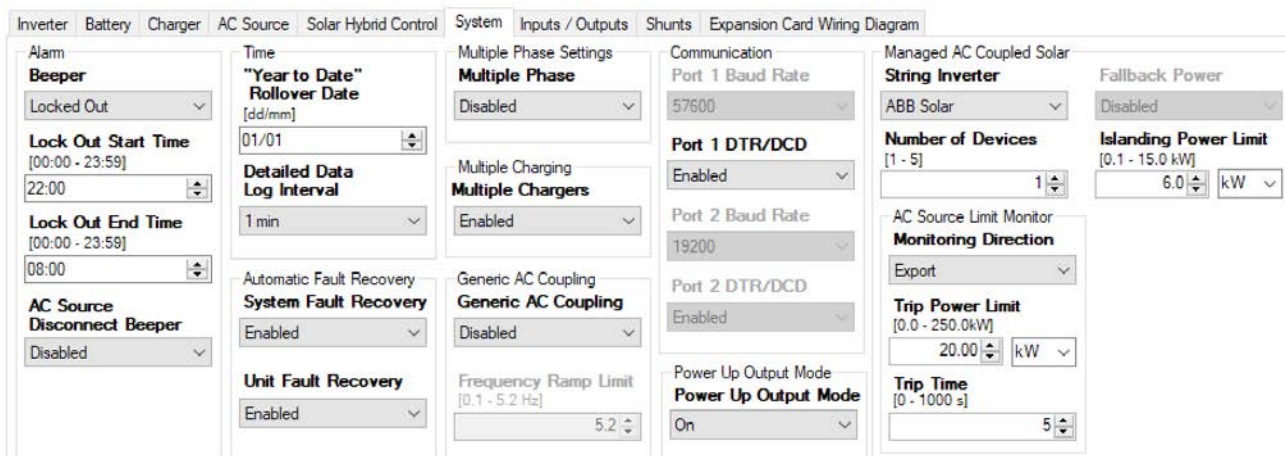

The screenshot shows the 'System' tab of the configuration interface. Key settings include:

- Alarm Beeper:** Locked Out
- Lock Out Start Time:** 22:00
- Lock Out End Time:** 08:00
- AC Source Disconnect Beeper:** Disabled
- Time 'Year to Date' Rollover Date:** 01/01
- Detailed Data Log Interval:** 1 min
- Automatic Fault Recovery System Fault Recovery:** Enabled
- Unit Fault Recovery:** Enabled
- Multiple Phase Settings Multiple Phase:** Disabled
- Multiple Charging Multiple Chargers:** Enabled
- Generic AC Coupling Generic AC Coupling:** Disabled
- Frequency Ramp Limit:** 5.2
- Communication Port 1 Baud Rate:** 57600
- Port 1 DTR/DCD:** Enabled
- Port 2 Baud Rate:** 19200
- Port 2 DTR/DCD:** Enabled
- Power Up Output Mode Power Up Output Mode:** On
- Managed AC Coupled Solar String Inverter:** ABB Solar
- Number of Devices:** 1
- AC Source Limit Monitor Monitoring Direction:** Export
- Trip Power Limit:** 20.00 kW
- Trip Time:** 5
- Fallback Power:** Disabled
- Islanding Power Limit:** 6.0 kW

The SP PRO is configured to recognise, and report, a number of events that can cause damage to the system, such as overloads, low voltage batteries. These events can be announced by a beeper within the SP PRO.

The Alarm - **Beeper**, may be set to:

Enabled - Beeper will activate at any time

Locked Out - Beeper will not activate during the Lock Out period. Set a **Lockout Start Time** and a **Lockout End Time**.

**Note:** Beeper will activate after lock out if existing alarm still persists.

Disabled - Beeper will not activate for any alarms.

The **AC source disconnect beeper** provides an alert signal (five short beeps), once per minute, if the SP PRO is not synchronised to the AC Source. This is disabled by default and must be Enabled if you wish the system to signal that it is running on battery supply during grid outages.

The Year to Date feature of the unit is used to monitor the systems performance on an annual basis. You can choose the start date of that year with "**Year to Date**" **Rollover Date**. This could be the day you installed it, the first day of the year or another date that is relevant to the installation.

Through **Detailed Data Log Interval** you can choose how often an entry is made. A short interval of 1 minute will give more detailed information, but for only four days. A long interval of 30 minutes will give less detail but 120 days of records. A 15 minute setting records for 60 days and gives a good balance between detail and the number of days recorded.

The SP PRO has the ability to automatically attempt to recover from a fault situation. If **System Fault Recovery** is enabled the SP PRO will monitor the situation that created the fault, such as low battery voltage, and return the inverter to operation if the battery voltage returns to a suitable level.

Similarly if **Unit Fault Recovery** is enabled an internal problem within the SP PRO, such as overheating, is monitored and normal operation continued if the problem is resolved.

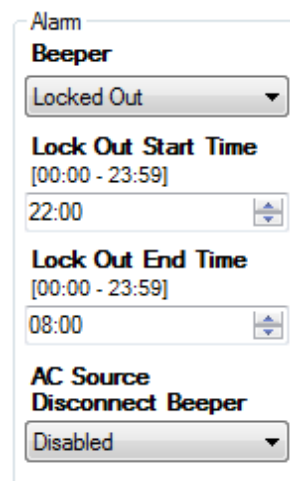

Alarm Beeper: Locked Out

Lock Out Start Time: 22:00

Lock Out End Time: 08:00

AC Source Disconnect Beeper: Disabled

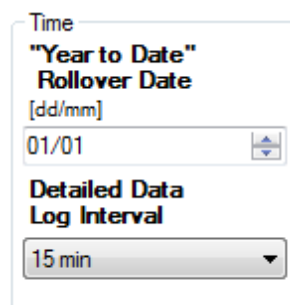

Time "Year to Date" Rollover Date: 01/01

Detailed Data Log Interval: 15 min

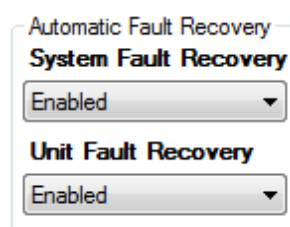

Automatic Fault Recovery System Fault Recovery: Enabled

Unit Fault Recovery: Enabled



The SP PRO can operate in a Multiple Phase configuration. The **Multiple Phase** setting in each SP PRO in these configurations must be set to either be the L1 - Primary controller, L2, L3 Secondary or Split phase - Secondary.

Any SP PRO that is configured as L2, L3 or Split Phase Secondary will have the Grid Disconnect and Inverter Disconnect functions in the Solar Hybrid Control disabled and greyed out. These functions are configured as required in the L1 - Primary SP PRO only which also controls these functions in all of the Secondary inverters.

Multiple Phase configurations require the use of external SYNC signalling and additional control wiring between each phase unit. Consult Three Phase installation instructions for further details including specific configuration requirements.

Systems with more than one SP PRO (two phase or three phase systems), have to be set to accommodate multiple SP PRO charging sources. For each SP PRO connected into the same battery bank, **Enable Multiple Chargers** is set to Enable.

**Generic AC Coupling** is only suitable for Solar Hybrid (On-Grid) systems and allows the grid connected solar to continue to supply power to the load and to charge the battery bank during a grid outage.

This setting allows the SP PRO to “kick off” any grid tie inverter that is connected to the AC Load side of the SP PRO by ramping the frequency of the AC output of the SP PRO. This AC Frequency ramp is triggered during a grid outage when the battery voltage rises to 2% above the SP PRO’s active Charge Voltage target. When the battery voltage drops to 2% below the battery charge target, the output frequency of the SP PRO will ramp back to nominal frequency.

**Frequency Ramp Limit** sets the maximum “Generic AC Coupling” ramp frequency of the SP PRO above the “Nominal AC frequency”. For example if the Nominal AC frequency is 50 Hz and the Frequency Ramp Limit is set to 2.5, then the output frequency of the SP PRO will ramp to 52.5 Hz during a Generic AC Coupled frequency ramp. This setting is available once **Generic AC Coupling** is enabled

The ON front panel button is used to set the SP PRO to either IDLE (SP PRO is monitoring but providing no AC output) or ON (Inverter output is operating normally) By default, when the battery supply is connected, the SP PRO will power up in IDLE mode. With the **Power Up Output Mode** setting, this can be changed to power up in ON mode without having to press the ON button.

The SP PRO is designed to communicate with an external computer, either directly connected or via a communications device to a distant location.

There are two ports for this data transfer. When connecting through a modem DTR/DCD control signals allow the modem to signal the SP PRO that a modem connection has been established and when that connection has been dropped.

These control signals can be enabled through **Port 1 DTR/DCD** and **Port 2 DTR/DCD** while the speed of the data flow can be set with **Port 1 Baud Rate** and **Port 2 Baud Rate**.

When connecting directly with a computer through the USB port or data cables the **Port 1 Baud Rate** would normally be set at 57600 bps (default).

Note: Port 1 DTR/DCD is only provided for backward compatibility with previous SP PRO models and is no longer supported.

Multiple Phase Settings  
**Multiple Phase**  
L2-Secondary ▼

Multiple Charging  
**Enable Multiple Chargers**  
Disabled ▼

Generic AC Coupling  
**Generic AC Coupling**  
Enabled ▼  
**Frequency Ramp Limit**  
[0.1 - 5.2 Hz]  
5.2 ▲▼

Power Up Output Mode  
**Power Up Output Mode**  
Idle ▼

Communication  
**Port 1 Baud Rate**  
57600 ▼  
**Port 1 DTR/DCD**  
Enabled ▼  
**Port 2 Baud Rate**  
9600 ▼  
**Port 2 DTR/DCD**  
Enabled ▼

“Managed AC Coupled Solar” Section activates the AC coupled features within the SP PRO including the communications link with the Selectronic Certified grid inverter.

The SP PRO Managed AC Couple Solar provides an efficient and convenient method of adding solar that is connected via the AC Bus.

**String Inverter** selects the brand of grid inverter(s) that are connected to the SP PRO in the Managed AC coupled system. Only one brand of grid inverter may be connected to the SP PRO although any mix of compatible models within that brand may be used.

The SP PRO firmware now comes in two versions, one for both Fronius and ABB Solar Managed AC coupling and a separate firmware for Powador Managed AC coupling. If the firmware within the SP PRO does not support the selected and configured **String Inverter** then SP LINK will go to the Firmware Update screen ready to update to the correct version of firmware. See **Firmware Update** on page 23



Communications Port 2 is not available when Managed AC Coupled Solar is selected.

Selections other than and ABB Solar may be listed for older versions of firmware or hardware and are provided for backward compatibility only.

**Number of Devices** sets the number of compatible inverters that are connected to the SP PRO in a Managed AC Coupled system. The maximum number of units is five so long as the combined AC output of all connected compatible grid inverters does NOT to exceeding twice the AC Power output rating of the SP PRO (some exceptions apply based on battery size - See Islanding Power Limit setting below).

**Monitoring Direction** determines how the AC Source Limit Monitor operates. When **Monitoring Direction** is Export, and the exported power to the grid is greater than **Trip Power Limit** for the **Trip Time**, the SP PRO signals the managed AC coupled grid inverters to turn off. Setting these limits to suit the requirements of the connected utility will ensure they are never exceeded.

When **Monitoring Direction** is Import, and the power drawn from the grid or Generator is less than **Trip Power Limit** for the **Trip Time**, the SP PRO signals the managed AC coupled grid inverters to turn off. This setting is useful in off grid systems to maintain a minimum load on the generator or grid connected systems where the utility requires a minimum draw from the grid.

**Fallback Power**. Only used with KACO Powador 00 or 02 series inverters built in 2014 or later. See “IN0018\_xx SP PRO KACO Managed AC Coupling Installation Notes”

**Islanding Power Limit** (firmware 8.00 and above). Limits the output power of all the connected compatible solar inverters when the SP PRO is islanding or Off Grid. This is useful in Solar Hybrid systems with small battery banks and allows the maximum amount of Solar to be installed and outputted when the system is connected to the grid by reducing this solar to a safe level when islanded (during a grid outage).

This setting is automatically set based on the SP PRO model, battery size and brand of Selectronic Certified grid inverter.

For more detailed information on Managed AC coupling please refer to the installation notes “IN0018\_xx SP PRO KACO Managed AC Coupling Installation Notes”, “IN0036\_xx 005150 SP PRO ABB Managed AC Coupling Installation Notes” or “IN0042\_xx 005230 SP PRO Fronius Managed AC Coupling Installation Notes” found on the web site [www.selectronic.com.au](http://www.selectronic.com.au)

Managed AC Coupled Solar

**String Inverter**

Fronius

**Number of Devices**  
[1 - 5]

2

AC Source Limit Monitor

**Monitoring Direction**

Import

**Trip Power Limit**  
[0.0 - 250.0kW]

0.50 kW

**Trip Time**  
[0 - 1000 s]

1

**Fallback Power**

Disabled

**Islanding Power Limit**  
[0.1 - 50 kW]

50.0 kW



## Input and Output Settings

The inverter contains 4 digital inputs, 4 relay outputs, 2 analogue inputs (excluding 120 V models) and 3 digital outputs, and these form the heart of the flexibility and sophistication of the SP PROs interface with the outside world.

With these controls you can monitor when various set points are reached, switch on appliances when certain criteria are met, protect the generator from damage due to low oil pressure, schedule a watering system to switch on and off and many other functions.



Maximum voltage to any input or output; 60 VDC. See SP PRO specifications for full details.

Inverter	Battery	Charger	AC Source*	Solar Hybrid Control	System	Inputs / Outputs	Shunts	Expansion Card	Wiring Diagram		
<b>Digital Inputs</b> <b>Low Batt Shut Down Override Input</b> None <b>Normal/Alternate AC Input Power Selector</b> None <b>Inhibit Export Input</b> None <b>Shutdown Input</b> None <b>Shutdown Level</b> Active High		<b>Digital Control</b> <b>Digital Control Input</b> None <b>Digital Control Output</b> None <b>Output State</b> Follow		<b>Analogue Control</b> <b>Analogue Control Input</b> Analogue Input 1 <b>Input Assert Level</b> [0 - 60 V] 12 <b>Input De-Assert Level</b> [0 - 60 V] 6 <b>Analogue Control Output</b> None		<b>Generator Inputs</b> <b>Generator Remote Start Input</b> None <b>Generator Available Input</b> Digital Control Input 3 <b>Generator Low Fuel Input</b> None <b>Generator No Fuel Input</b> None <b>Generator Fault Input</b> Digital Control Input 2		<b>Generator Outputs</b> <b>Generator Run Output</b> Relay Output 1 <b>Generator Start Output</b> Relay Output 2		<b>Alarm Output</b> <b>Alarm Output</b> Relay Output 4 <b>Alarm Type</b> Alert + Shutdown <b>ABB Ground Fault Alarm Output</b> None	

**Low Batt Shutdown Override Input** function is also known as the “Just Go” control. In case of emergency, even if the batteries would normally be considered too flat to safely run the inverter, activating this input will force the inverter to run, until there is insufficient battery power left to maintain the load. This is considered essential if, say, phones or a fire pump MUST be operated.

When a second AC Source with a different capacity to the primary AC Source (Normal), is available to the system, use the **Normal/Alternate AC Input Power Selector** setting to set the input that you wish to use to select the alternate power level. The alternate source power level is configured in Alternative AC Source Power back in the AC Input section. When Alternate is selected, Solar Hybrid Control Priority schedules are overridden and no longer apply.

In some circumstances you may wish to prevent the SP PRO from exporting excess energy to the grid such as when the grid has failed and you have connected a diesel generator into the system. Using **Inhibit Export Input** in conjunction with the Normal/Alternate AC Input you can switch to a different power level and know that the SP PRO will not try to export power to the motor generator.

**Shutdown Input**, when active, will turn off the inverter section of the SP PRO and prevent any charging or discharging of the battery bank. Driving this input from the warning output of a Battery Management Systems (BMS) will provide a failsafe shutdown of the inverter. For Off Grid systems with auto start generators, the generator will start whilst this input is active and restore power to the site.

**Shutdown Level** selects the level at which the Shutdown Input is active

<b>Digital Inputs</b> <b>Low Batt Shut Down Override Input</b> None <b>Normal/Alternate AC Input Power Selector</b> None <b>Inhibit Export Input</b> None <b>Shutdown Input</b> None <b>Shutdown Level</b> Active High
--

The DIGITAL CONTROL section is used to switch an output on or off with a digital input. For example, if the input that is set in **Digital Control Input** setting (Digital Input 2 in the example) is activated then the output set in **Digital Control Output** will be controlled (Relay Output 4 in this example) The output can be reversed using the **Output State** setting. In the given example a positive input to Digital Control Input 2 from an upper float switch could switch off a water pump via Relay Output 4.

In short you can control many different types of appliances or warning devices from digital inputs.

The switching of a digital input is recorded as events on the event log and can be monitored by downloading data.

The SP PRO has two analogue inputs that can control the full range of output options. The analogue input is set in **Analogue Control Input**. An analogue input differs from a digital input in that instead of reacting to an on/off type signal as a digital input does. An analogue input reacts to a pre-programmed upper and lower voltage level which are set in **Input Assert Level** (on voltage point) and **Input De-Assert Level** (off voltage point).

As an example if a suitable moisture sensor was connected to Analog Input 1 the output from Relay Output 3 could be used to switch a watering system on and off depending on the moisture content of the soil.

A Selectronic Accredited Integrator can help you with specific applications that you may require.

To remotely start the generator set **Generator Remote Start Input** to one of the digital inputs to perform this function. There are 2 modes of operation:

- **Momentary Switch:** If this input is pulsed on for less than 2 seconds the SP PRO will see this as a pulse start and start the generator. A subsequent pulse for less than 2 seconds will stop the generator.
- **On / Off Switch:** If the remote switch is turned on and left on for at least 5 seconds, the SP PRO will continue to run the generator until the switch is turned off at which point the SP PRO will stop the generator.

The digital inputs can be used to protect the motor generator. One or more of the digital inputs can be configured to activate actions, warnings and shut down protection. In the **Generator Available Input** setting you can determine whether the generator is available for automatic control. This is particularly useful to prevent the generator from starting during maintenance or refuelling.

The **Generator Low Fuel input** will initiate an alarm when a suitably positioned sensor provides a warning that the fuel level within the fuel tank is low.

The **Generator No Fuel input** will either stop the generator or prevent the SP PRO from attempting to start the generator when there is no fuel.

The **Generator Fault input** can detect signals from the generator control system to either stop the generator or prevent the SP PRO from attempting to start the generator when a fault is present in the generator.

Digital Control

**Digital Control Input**

None ▼

**Digital Control Output**

None ▼

**Output State**

Follow ▼

Analogue Control

**Analogue Control Input**

Analogue Input 1 ▼

**Input Assert Level**  
[0 - 60 V]

12 ▲▼

**Input De-Assert Level**  
[0 - 60 V]

6 ▲▼

**Analogue Control Output**

None ▼

Generator Inputs

**Generator Remote Start Input**

None ▼

**Generator Available Input**

Digital Control Input 3 ▼

**Generator Low Fuel Input**

None ▼

**Generator No Fuel Input**

None ▼

**Generator Fault Input**

Digital Control Input 2 ▼



In Generator Outputs you can configure the Run and Start outputs to suit the starting requirements of the motor generator. **The Generator Run Output** will provides a start and run signal for a two wire generator controller. The **Generator Start Output** provides a start and stop pulse signal for three wire generator controllers. See Signal Timing under the Generator Controller settings.

The SP PRO can alert you when there is a problem that may prevent the smooth operation of the power system. This is achieved by configuring one of the outputs in the SP PRO to activate an external alarm, visual or audible, to alert you to a problem.

The **Alarm Output** field allows you to choose which output will be activated during an alarm condition. NOTE that the **Alarm Output**. is reverse logic and that the output is active when the alarm is off. This allows the Normally Closed (NC) contacts of one of the relay outputs to be used thereby triggering an alarm condition during a complete system shutdown and loss off Battery supply to the SP PRO.

The **Alarm Type** field lets you choose whether you will be advised of Alerts (warnings of potential problems), Shutdowns (events that have caused the inverter to shut down) or both.

The **ABB Ground Fault Alarm Output** can only be used in a Managed AC coupled system using ABB grid inverters. This output will become active when any of the ABB grid inverters in the system develops a ground fault. This output is set to the last ABB Ground Fault Alarm Message received.

The SP PRO SILENCE ALARM button does not deactivate this output.

The SP PRO can help you to manage the system by advising you when certain output levels have been exceeded. **AC Load Energy Output** selects the output that will be asserted when the daily energy consumption exceeds **Energy Assert Level** setting.

**AC Load Power Output** selects the output that will be asserted when the AC load on the system exceeds the **Power Assert Level** for 30 seconds. Conversely the output is de-asserted when the AC load drops below the **power Assert Level** for 30 seconds.

For example let's assume the system has been designed to provide 10 kilowatt hours a day and any load exceeding 5 kilowatts is considered excessive.

In the example on the right, **AC Load Energy Output** has been set to Digital Control Output 1 and this output will be activated when the daily usage reaches 9 kilowatt hours, as programmed into **Energy Assert Level**.

When set in this way the inverter will advise you, but asserting Digital Control Output 1, when you are approaching the design limit of the system and allow you to choose if you wish to modify the power consumption for the remainder of the day. Similarly **AC Load Power Output** has been allocated to Digital Control Output 2 which will be activated if the AC load on the system exceeds the **Power Assert Level** of 4.5 kW for 30 seconds.

**External Regulator Bypass Output** can be used to control a relay that will bypass the solar or wind generator regulator to allow the full renewable output to be forwarded to the battery or exported to the grid.

The **External Regulator Control Output** provides a signal to drive an external solar regulator

Generator Outputs

**Generator Run Output**  
Relay Output 1

**Generator Start Output**  
Relay Output 2

Alarm Output

**Alarm Output**  
Relay Output 4

**Alarm Type**  
Alert + Shutdown

**ABB Ground Fault Alarm Output**  
None

AC Load Outputs

**AC Load Energy Output**  
Digital Control Output 1

**Energy Assert Level**  
[1 - 1000 kWh]  
9

**AC Load Power Output**  
Digital Control Output 2

**Power Assert Level**  
[0.1 - 15.0 kW]  
4.5

Extern. Regulator Outputs

**External Regulator Bypass Output**  
None

**External Regulator Control Output**  
Digital Control Output 1



The **AC Coupled Inverter Output** drives an external solid state relay to control when the AC Coupled inverter feeds to the grid, local AC Load and battery bank. This is suitable for switching any Grid feed inverter. This setting is only available for Solar Hybrid (grid connected) configurations.



Any generic AC Coupling is best controlled via AC Frequency. See System settings Generic AC Coupling. The **AC Coupled Inverter Output** is a legacy setting retained for backward compatibility only.

**Zero Percent Output** setting is configured automatically when the ABB Solar inverter is selected in a Managed AC Coupled Solar configuration. This is for display only and cannot be changed.

If you are using an external contactor **External AC Contactor Control Output** provides a control signal for actuating the contactor coil. See AC Source AC Input to Enable the External Contactor/CT functionality.

This control is also used to provide a grid failure alarm. The output is active during a grid outage.

**AC Source in Tolerance Output** configures an output to become active when the AC source voltage and frequency are in tolerance according to the settings in AC Source / AC Input tab. This output can be used in a mutiphase configuration where it is a requirement for all phases to disconnect from the AC source when one or more phases are out of tolerance. Using this output L2-Secondary and L3-Secondary inverters can signal L1-Primary via the Grid Available Input that they are in tolerance before L1-Primary connects all phases to the AC Source.

**High Battery Alert Output** is initiated on the chosen output when the battery voltage reaches the Hi Battery Alert set point in the Limits section in the Battery Settings section.

**Battery SoC Output** initiates the chosen output when the **SoC Assert Level** reaches the programmed SoC Assert Level then switches off the output when the **SoC De-Assert Level** is reached.

If the **SoC Assert Level** is lower than the **SoC De-Assert Level** then the output will become active when the battery SoC drops below the **SoC Assert Level** then deactivate when the battery SoC rises above the **SoC De-Assert Level**.

If the **SoC Assert Level** is higher than the **SoC De-Assert Level** then the output will become active when the battery SoC rises above the **SoC Assert Level** then deactivate when the battery SoC drops below the **SoC De-Assert Level**.

The **Battery Voltage Output** setting is similar to the prior setting but is based on battery voltage instead of state of charge.

AC Coupled Inverter Output  
**AC Coupled Inverter Output**  
None

Zero Percent Output

Digital Control Output 3

External AC Contactor

**External AC Contactor Control Output**

None

**AC Source In Tolerance Output**

None

Battery Outputs

**High Battery Alert Output**

None

**Battery SoC Output**

None

**SoC Assert Level**

[0 - 100 %]

60

**SoC De-Assert Level**

[0 - 100 %]

90

**Battery Voltage Output**

None

**Voltage Assert Level**

[0.0 - 70.0 V]

0.0

**Voltage De-Assert Level**

[0.0 - 70.0 V]

0.0





BATTERY CHARGER INPUTS are used in a variety of ways to help integrate the SP PRO with other renewable chargers. All work in a similar way but just move the charger to a different charging mode.

Care must be taken when using these inputs as improper use can prevent the charger working correctly. Consult a Selectronic Authorised Integrator for assistance.

The most commonly used would be the Float Stage Input.

**Float stage input.** Using the drop down menus you can choose which Digital Input you wish to use to control a function. Making this input high or active (> 10 V DC) will force the inverter charge controller into the “Float” stage of the charging process.

**Float Stage Edge** Consult the regulator manufacturer to determine the output signal the chosen regulator provides. The most common is the default of Rising edge.

**Note:** SoC will be set to 100% when Float Charging Mode is entered.

Battery Charger Outputs also help with integration of external chargers but also be used to turn on or off various loads depending on what charge stage the charger is in. All outputs work in the same way, when the charger is in that charging phase, the corresponding output will turn on and subsequently turn off when no longer in that charging phase.

For example, you may wish to only turn on any pumping equipment when the charging process is nearing completion and whilst the charger remains in Float. By selecting the same output “Digital Control Output 3” for both **Absorb Stage Output** and **Float Stage Output** then the output will remain on during both of those charging stages.

The **Timed Assert Output** schedule similar to the generator run schedule is also provided for a digital output. This facility allows you to control the regular operation of appliances around the home. A typical example would be to turn on a watering system every night for a fixed period.

Battery Charger Inputs

<b>Initial Stage Input</b> None	<b>Initial Stage Edge</b> Rising
<b>Bulk Stage Input</b> None	<b>Bulk Stage Edge</b> Rising
<b>Absorb Stage Input</b> None	<b>Absorb Stage Edge</b> Rising
<b>Float Stage Input</b> Digital Control Input 1	<b>Float Stage Edge</b> Rising
<b>Equalise Stage Input</b> None	<b>Equalise Stage Edge</b> Rising

Battery Charger Outputs

<b>Initial Stage Output</b> None
<b>Bulk Stage Output</b> None
<b>Absorb Stage Output</b> None
<b>Float Stage Output</b> None
<b>Equalise Stage Output</b> None

Timed Assert Output

<b>Timed Assert Output</b> None	<b>Schedule 1</b> Disabled	<b>Schedule 2</b> Disabled	<b>Schedule 3</b> Disabled	<b>Schedule 4</b> Disabled
	<b>Sched. 1 Day</b> All	<b>Sched. 2 Day</b> All	<b>Sched. 3 Day</b> All	<b>Sched. 4 Day</b> All
	<b>Sched. 1 Start Time</b> [00:00 - 23:59] 00:00	<b>Sched. 2 Start Time</b> [00:00 - 23:59] 00:00	<b>Sched. 3 Start Time</b> [00:00 - 23:59] 00:00	<b>Sched. 4 Start Time</b> [00:00 - 23:59] 00:00
	<b>Sched. 1 Stop Time</b> [00:00 - 23:59] 00:00	<b>Sched. 2 Stop Time</b> [00:00 - 23:59] 00:00	<b>Sched. 3 Stop Time</b> [00:00 - 23:59] 00:00	<b>Sched. 4 Stop Time</b> [00:00 - 23:59] 00:00

The final section controls the Solar Hybrid function allowing for a Backup Generator to be automatically controlled during times of Grid failure.

These setting must be used in conjunction with an optional external controller supplied by Selectronic. Full details of correct settings will be supplied with the optional controller.

Grid Fail Generator Backup

**Grid Fail Backup**

**Grid Available Input**

**Backup Select Output**

## Shunts Settings

Inverter	Battery	Charger	AC Source	Solar Hybrid Control	System	Inputs / Outputs	Shunts	Expansion Card Wiring Diagram
----------	---------	---------	-----------	----------------------	--------	------------------	--------	-------------------------------

**Shunt 1**

**Name**

**Max Voltage**  
 [25 - 100 mV]

**Max Current**  
 [25 - 1000 A]

**Shunt 2**

**Name**

**Max Voltage**  
 [25 - 100 mV]

**Max Current**  
 [25 - 1000 A]

The Shunts tab contains settings required to configure the connected DC current shunts that are used to measure the currents going in or out of the battery bank. The shunt readings are used by the SP PRO series to accurately calculate the state of charge of the batteries (System SoC).

A shunt is not normally required to measure the SP PRO battery current as this is measured internally.

Both shunts are configured for their maximum current and the millivolts at that maximum current. For example for a current shunt rated at 75mV 100A, **Max Voltage** = 75 and **Max current** = 100.

The table below describes the function of each of the Shunt Names

SHUNT TYPE	DESCRIPTION
<b>Solar, Wind, Hydro, Charger</b>	Unidirectional - Measures charging sources. Always assumes charging current so the polarity of the shunt is not critical
<b>Load</b>	Unidirectional - Measure DC loads. Always assumes load current so polarity not critical..
<b>Dual</b>	Bidirectional - Measure DC charging and DC loads. The polarity of the shunt IS critical.
<b>Multiple SP PROs</b>	Bidirectional - Legacy setting that was previously used in Off Grid, multiphase (three phase of split phase) SP PRO systems to measure L2 and/or L3 battery currents. The polarity of the shunt IS critical. Multiphase systems now use the System SoC shunt setting
<b>Log Only</b>	Bidirectional - Used to measure and log a current that is NOT part of the system battery current measurement. This shunt type does to affect the battery current or System SoC.
<b>System SoC</b>	Bidirectional - Used in multi phase (three phase of split phase) SP PRO systems and if selected then ONLY the current measured by this shunt type will effect the system SoC or effect the transition from Absorb to Float (see Battery Charger Section) . All battery currents measured from any other shunt type or from the internal SP PRO battery current reading will only effect the battery current reading for that individual SP PRO inverter within a multi phase system.
<b>Direct SoC Input</b> (Shunt 1 only)	This setting changes the function of the Shunt 1 input to an analogue input that measures the State of Charge (SoC) from the analogue output of a Battery Management System (BMS). The <b>Voltage for 100% SoC</b> sets the input voltage that generates a 100% SoC within the SP PRO and has a maximum setting of 100mV. If the BMS output is greater than 100mV for 100% SoC then a voltage divider will need to be inserted.  When selected, this input overrides the internal SoC calculation.



## Expansion Card Wiring Diagram

The Configuration Setting Expansion Card Wiring Diagram shows how you have allocated the input and output functions. It can be used as a guide to placement of control wiring. This diagram is a display of the Configuration Settings on the PC, not the actual settings in the SP PRO.

This guide can be printed for reference during installation and will also include the Site Information.

Expansion card picture may vary depending on SP PRO model. Click Change Card Type to change display to suit the model.

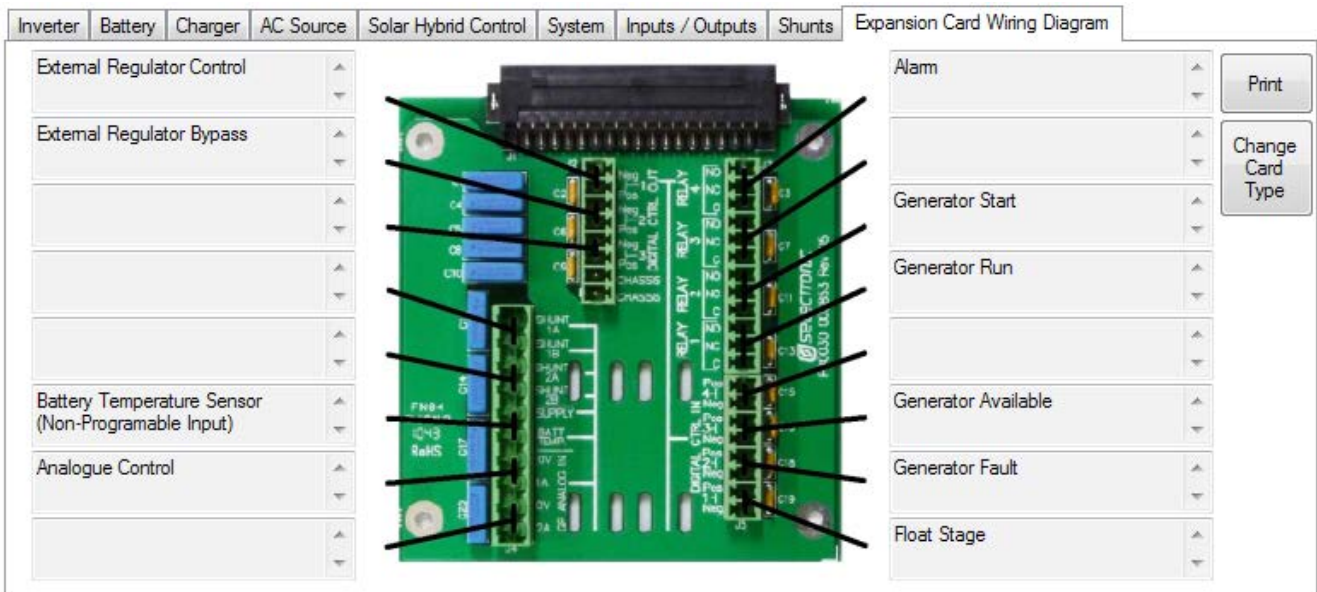

Default configuration shown.

## Save and Configure Settings

The configuration settings may now be saved to file or sent to the SP PRO using the “Configure SP PRO” button.

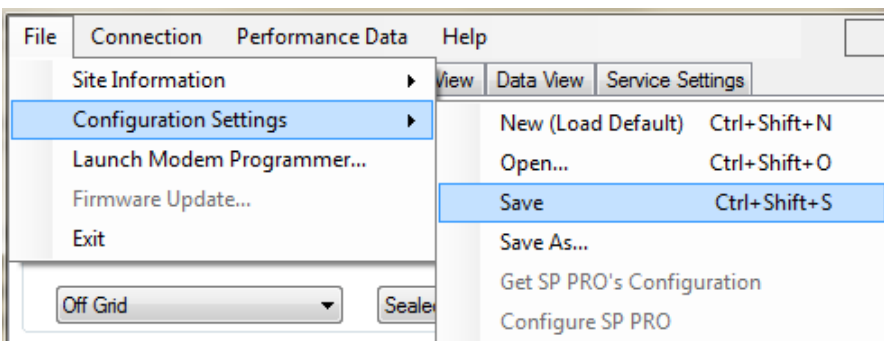

To save the SP PRO configuration settings, click on File - Configuration Settings - Save.

To configure the SP PRO, ensure SP LINK is connected (via connection menu) to the SP PRO and then click “Configure SP PRO” either on the Configuration Screen or in the File - Configuration Settings menu.

Remember that all settings are sent to the SP PRO, not just the ones you have changed. The default passcode is 74. It can be changed in Service Settings.



# Performance Monitoring



SP LINK provides a number of options to monitor in real time or review the history of all modes of operation of the power system. These options are -

- Customer Interface
  - Quick View - real time summary of SP PRO system
- Integrator / User Interface
  - Data View - real time detailed information of what is occurring
    - Now,
    - Today and what has occurred
    - Historically
- Integrator / User information
  - Performance Data
    - Historical records for displaying graphically

## Customer Interface

The customer interface is called Quick View. Quick View presents you with a screen that mimics the front panel of the SP PRO along with a real time overview of the condition of the system.

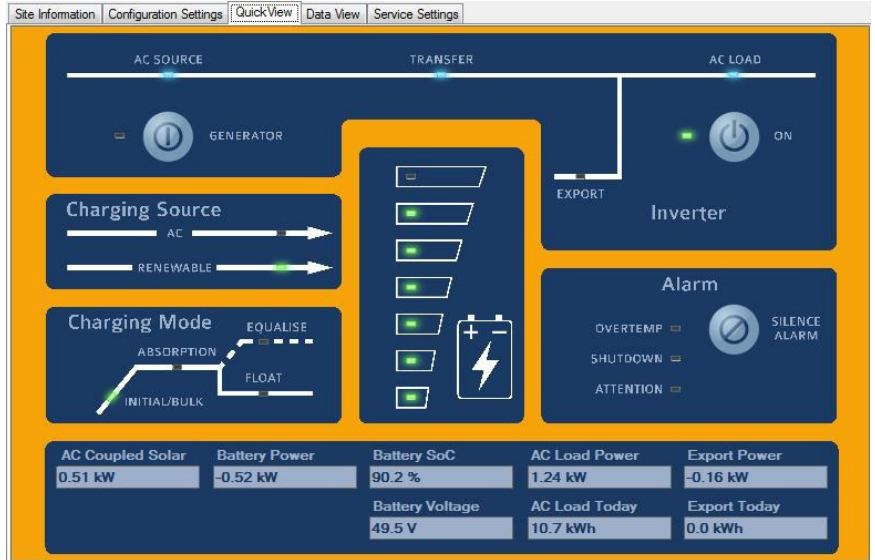

QuickView can easily be accessed directly from the computers desktop. Click the SP LINK Auto QuickView icon (installed automatically with SP LINK) and the last site will automatically be loaded and a connection (if possible) established.

## Integrator / User Interface

The Integrator and User interface is called Data View. Data view contains a number of sections which provide numerical details on the systems operation and status of the SP PRO.

Each section contains details for

- Now
- Today
- DC History
- AC History
- Technical Data
- Expansion Card Wiring

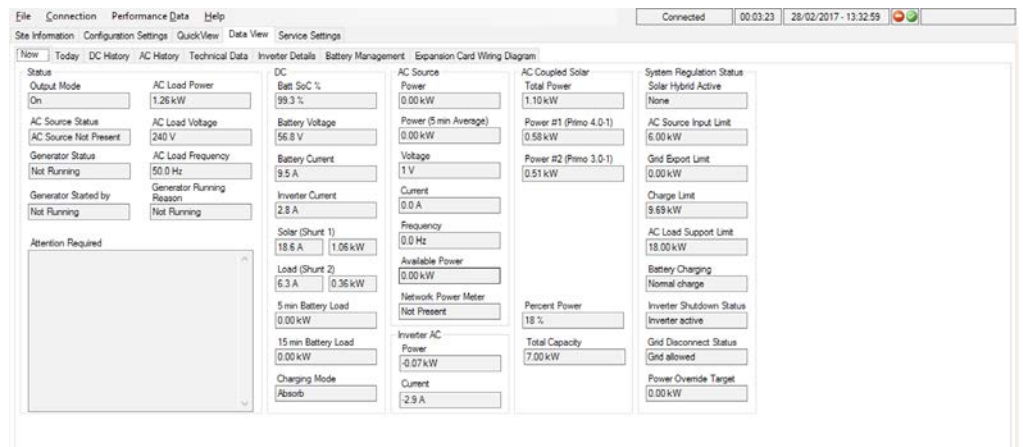

## Quick View

Quick View presents you with a screen that mimics the front panel of the SP PRO along with a real time overview of the condition of the system.

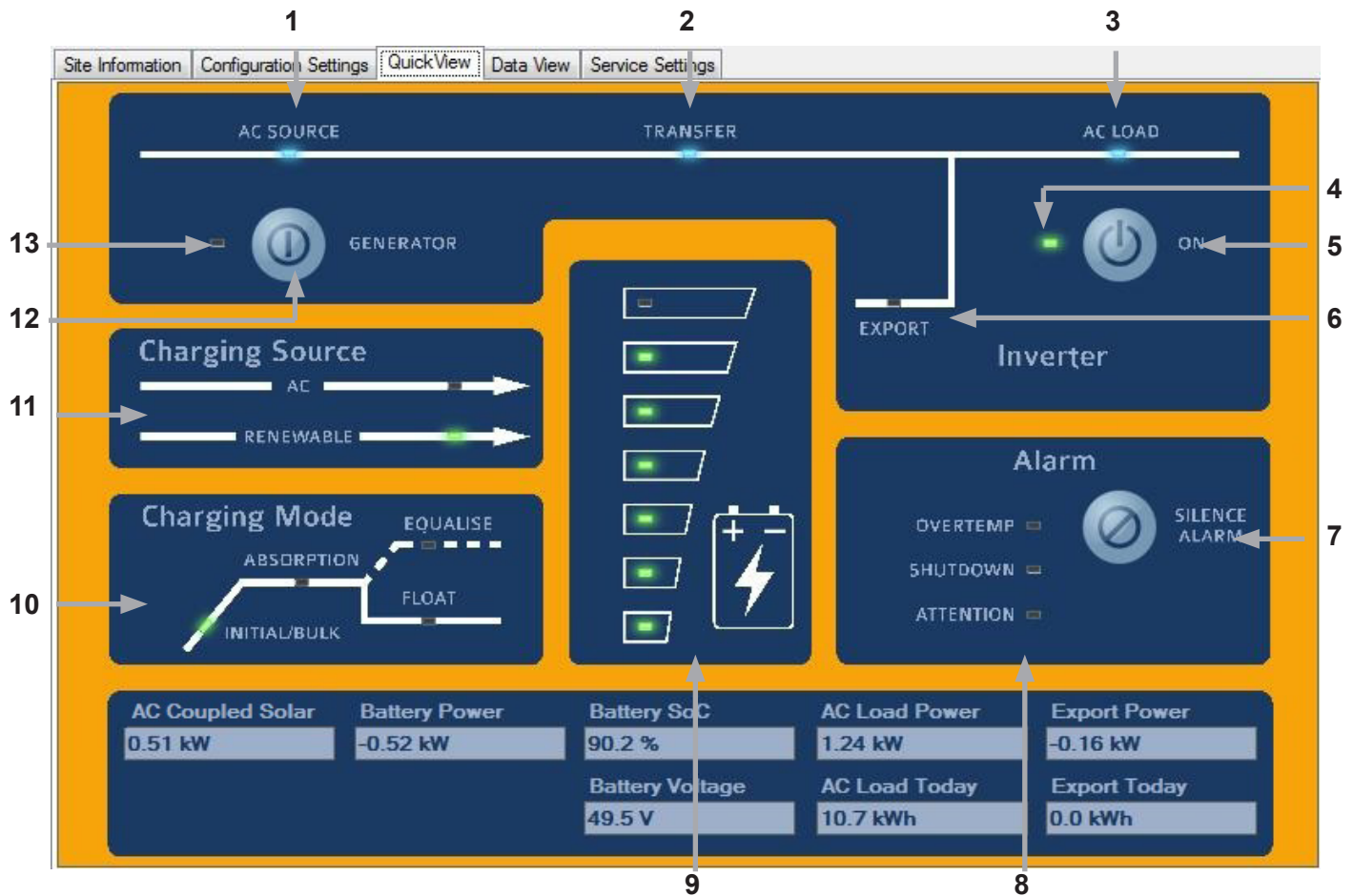

The following page lists the SP PRO control and indicators which correspond to the labelled image above.

The overview shown is for a Solar Hybrid (On Grid) system. The real time overview values shows how much power is being produced (AC Solar) and exported (Export Power and Export Today) as well as the present consumption (AC Load Power and AC Load Today). The battery condition (Battery SoC and Battery Voltage) is also indicated.

The overview for a Off Grid system varies slightly such that the Export Power and Export Today are replaced by the Generator Status and Gen Started.

AC Coupled Solar	Battery Power	Battery SoC	AC Load Power	Generator Status
2.12 kW	2.06 kW	98.4 %	0.38 kW	Not Running
Solar (Shunt 1)	Load (Shunt 2)	Battery Voltage	AC Load Today	Gen Started
1.01 kW	0.65 kW	57.1 V	3.4 kWh	Not Running

DC shunts are enabled in this example and their real time values are shown as Solar (Shunt 1) and Load (Shunt 2).



**1 AC SOURCE \***

When illuminated shows the presence of AC supply voltage from either a generator or the grid, whichever is applicable. This is powered directly from the incoming AC supply.

**2 TRANSFER \***

Illuminated when an external AC supply is connected through to the AC LOAD output. If AC SOURCE is illuminated but not TRANSFER, it would indicate that either the AC supply's voltage or frequency are beyond the set limits or the active Priority Schedule is set to "Grid Disconnected". If the AC supply is a motor generator, check if it needs servicing; if the mains grid, check with your supplier for a problem, or for either, that the set limits are suitable. It is normal operation for this to flicker slightly.

**3 AC LOAD \***

When illuminated, this shows the presence of AC voltage ready to supply loads. This is powered directly from the inverter AC output or AC supply.



The above indicators (1,2 & 3) will operate without any DC connection to the inverter. An external AC supply will activate the AC bypass and illuminate these indicators.

**4 OUTPUT MODE STATUS**

- Off** Inverter is disconnected from Battery supply. AC bypass only.
- Slow Flashing Yellow** Inverter is Idle (Off) - Monitoring and logging but no inverter AC output.
- Steady Green** Inverter is On.
- Slow Flashing Green** Econo mode is active and sensing
- Fast Flashing Green** Inverter is preparing to start.
- Steady Red** Indicates that a Fault has been detected and inverter is shutdown.
- Flashing Red** Indicates an open circuit or poor battery connection or inverter not configured. Inverter is shutdown.

**5 ON BUTTON**

A LONG PRESS (>1 second) - turns the Inverter On. Another long press reverts to Idle.  
A SHORT PRESS (<1 second) - activates Econo mode (If Enabled in Configuration Settings > Inverter).

**6 EXPORT**

In grid connected systems, indicates that the SP PRO is feeding renewable power: to the load or the grid.  
**On**, renewables exporting to the grid and supplying Loads;  
**Flashing**, renewables supplying Loads only.  
NOTE: The EXPORT indicator may flicker occasionally at night when no renewable are available. This is normal operation and is due to transients in the load power or grid voltage.

**7 SILENCE ALARM BUTTON**

The Silence Alarm button cancels any audible alarm. This does not remove the alarm, just the audible component. This button is not active when SP PRO is in Idle.

**8 ALARM INDICATORS**

**OVERTEMP**

- Yellow** SP PRO is approaching an over temperature condition
- Red** SP PRO has shutdown due to an over temperature condition

**SHUTDOWN**

- Yellow:** SP PRO is approaching a shutdown condition
- Red** SP PRO has shutdown

**ATTENTION**

- Off** Normal
- Yellow** Attention Required, Fan Service Request
- Flashing Yellow** Clean Fan, Fan Fault or Capacitor Service
- Red** Immediate Attention required
- Flashing RED** Unit Fault

See Attention Required in SP LINK Data View - Now section to determine specific reason for the attention indicator.

**9 BATTERY "FUEL" GAUGE**

These represent either the battery voltage or State of Charge (SoC). By default, battery voltage is indicated. All indicators on green indicate Float or higher voltage. If just the bottom indicator is on red, battery voltage is approaching the SP PRO Shutdown voltage.

If the SP PRO has SoC Control enabled, these will represent the percentage of usable charge remaining in the batteries. Usable charge is defined from 100% SoC down to the Shutdown SoC parameter.

**Top Indicator**

**Flashing RED:** Instant Hi DC Voltage Shutdown

**Bottom Indicator**

- Yellow** Low Battery
- Red** Low Battery Shutdown
- Flashing RED** Instant Low DC Voltage Shutdown

When all are flashing RED, inverter is in Low DC Shutdown Override. In emergency situations, this override enables the SP PRO to be forced to work beyond the battery shutdown limits. The SP PRO will continue to operate at reduced capacity until the battery can no longer supply enough to keep the inverter and loads running. We remind you, this emergency feature may damage the batteries or connected equipment.

**10 CHARGING MODE**

The Charging Mode panel indicates the present charging mode being performed by either connected Charging Source, or the stage that will be started when Renewable or external AC supply becomes available. **Note:** SoC will be set to 100% when Float Charging Mode is entered.

**11 CHARGING SOURCE**

- AC - On External AC supply charging battery bank
- Renewable - On Monitored renewable supply is charging battery bank

DC Coupled renewable supplies must be monitored via an external current shunt(s) to activate this indicator.

**12 GENERATOR START/STOP BUTTON**

A brief press of this button (<1 second) will start or stop the generator..  
Two Long presses - Set or cancel Equalise Charge pending (see Click here for Request Battery Equalise on page 83.

**13 GENERATOR STATUS**

- Off** No generator activity
- Flashing Green** Generator is in the process of starting
- Steady Green** Generator has started and is running
- Flashing Yellow** Generator is not available for auto start
- Flashing Red** There is a generator fault







## DC

This screen gives you vital information about the state of the batteries at the time of viewing. The BATT SoC% indicates the actual capacity left in the batteries, just like a fuel gauge in your car, and will help you make decisions about the power consumption for the rest of the day. Similarly the Battery Voltage gives a rough guide to battery condition.

The next four readings give you an overview of what's going into and coming out of the batteries. Inverter Current shows the amperage being used by the SP PRO to run AC loads or the amperage being contributed to battery charging if the generator is running. DC BATTERY CURRENT is the nett amount going into or out of the battery pack. If the Solar Current is greater than the loads a positive figure will be shown while if the loads are greater than the combination of charging sources a negative figure will appear. Load Current is the measurement of DC loads monitored by the Load shunt.

CHARGING MODE indicates the active stage - Initial, Bulk, Absorb, Float (Short or Long Term) or Equalise Charging.

**Note:** SoC will be set to 100% when Float Charging Mode is entered.

## AC SOURCE

This section displays the contribution and condition of the mains grid or motor generator that is connected to the SP PRO AC source input.

POWER reading is the input power in kilowatts.

POWER (5MIN AVERAGE) is the average power in kW over the last 5 minutes.

VOLTAGE is the RMS AC voltage.

CURRENT is in Amps.

AVAILABLE POWER is the difference between the POWER reading and the AC SOURCE POWER setting in the SP PRO. The SP PRO will automatically reduce the charge power to the batteries or draw power from the batteries as required to keep the AC Source power below the AC SOURCE POWER Setting.

NETWORK POWER METER displays the total power as measured by an externally connected three phase power meter. Contact Selectronic or visit the web site for more information.

## INVERTER AC

This panel is similar to the preceding panel except that it shows the Inverter Power and Current from the inverter.

## AC COUPLED SOLAR

The panel shows the total Power and individual output powers from each of the connected compatible grid Inverters. These are listed as Power #1 through to Power #5 along with the grid inverter's model number (when connected). If the SP PRO has lost communications with the grid inverter or the grid inverter has gone to "sleep" at night, the message "Inverter Offline" is displayed.

PERCENTAGE POWER is the maximum output of all the connected compatible grid inverters as a percentage of the TOTAL CAPACITY. As an example if the TOTAL CAPACITY is 10kW and the PERCENTAGE POWER IS 50% then the maximum output from all the connected grid inverters is 5kW.



The PERCENTAGE POWER may be displaying less than 100% even though no power limiting is required. This is because the SP PRO intelligently uses predictive algorithms to determine the optimum value based on the available solar input to the grid inverter at that time

TOTAL CAPACITY is the total rated power of all the connected grid inverters. This reading will drop to zero when the grid inverters go to "sleep" at night.

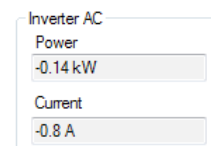
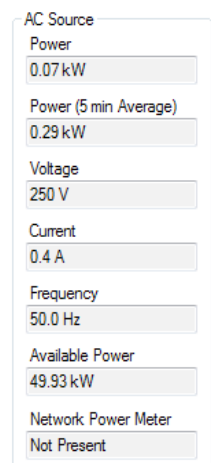
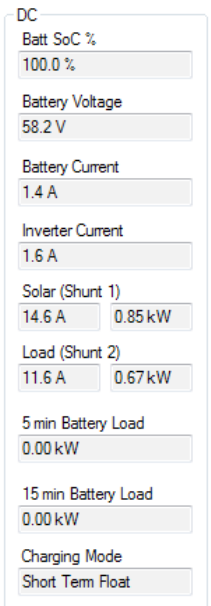

## SYSTEM REGULATION STATUS

This panel shows the control status and power limits active within the SP PRO mainly for the Solar Hybrid Control configurations. These power limit values also hold true for Off Grid and Mobile. These values are the configured maximums defined by the Solar Hybrid Control however the system may not be capable of achieving these values and can be overruled.

**SOLAR HYBRID ACTIVE:** Shows the active Priority Schedule (1 - 8), Alternate or None.

- PRIORITY 1 TO PRIORITY 8: Indicates the currently active Priority Schedule.
- NONE: indicates that no Priority Schedules are active at this time.
- ALTERNATE indicates the Alternate AC Input is active and all Priority Schedules are overridden.

The items listed below are the configuration values and limits for the SOLAR HYBRID ACTIVE

**AC SOURCE INPUT LIMIT:** The maximum AC Source (Grid or Generator) input power allowed for AC Load or Battery Charging at this time. This limit will be breached if the AC Load demands more power than this limit and AC LOAD SUPPORT LIMIT combined.

**GRID EXPORT LIMIT:** The maximum Grid export power allowed at this time. This limit will always be 0,00kW when the Unit Application is set to Off Grid or Mobile.

**CHARGE LIMIT:** The maximum Battery Charge power allowed at this time. The Charge Power will be capped at this value regardless of the charge power required by the SP PRO Charger (See Configuration Settings > Charger). The CHARGE LIMIT will display the maximum charge limit of the SP PRO when either:

- No Priority Schedules are active
- The Restricted Charge Limit setting in the active Priority Schedule is greater than the maximum charge limit of the SP PRO

**AC LOAD SUPPORT LIMIT:** The maximum AC Load power that can be taken from the battery bank. This limit will be breached if the SP PRO is not synchronised to the AC Source input.

**BATTERY CHARGING:** Shows the status of the SP PRO Battery Charging function:

- RESTRICTED CHARGE, The Charge power is restricted to the CHARGE LIMIT within a Priority Schedule
- CHARGER OFF. The Charge is off and wont charge the battery. The AC LOAD SUPPORT LIMIT is still active
- RENEWABLE ONLY Allows battery recharging from both AC Coupled or DC coupled renewable sources but not from the AC Source (Grid) supply.
- NORMAL CHARGE. This is displayed when no Priority Schedules are active.

**INVERTER DISCONNECT STATUS:** Shows if the inverter within the SP PRO is active or disconnected.

- INVERTER ACTIVE: all the normal charging and support functions operate.
- INVERTER DISCONNECTED: There is no AC Battery Charging (AC Coupled or Grid), AC Load Support, AC Source Input Limit or any Support or Export from DC coupled solar. If the Grid is interrupted, the Inverter switches on after a short break in supply (< 1.0 seconds) to provide back-up power.

**GRID DISCONNECT STATUS:** Shows if the Grid is allowed or is being kept disconnected

- GRID ALLOWED: The SP PRO will synchronise to the grid when available.
- GRID DISCONNECTED: The SP PRO will not synchronise to the grid even though the grid maybe within voltage and frequency tolerance.

If INVERTER DISCONNECTED is active during GRID DISCONNECTED, the GRID DISCONNECTED will be overridden.

**POWER OVERRIDE TARGET:** No function within standard SP PRO units. Contact Selectronic for details.

**Recovering Message:** When the battery State of Charge (SoC) reaches the **SoC Support Limit** within the active Priority Schedule the highlighted message "Recovery" appears within the affected reading. When the SoC recovers by 20% of the discharge (eg from 60% to 68%) the displayed readings return back to normal.

System Regulation Status	
Solar Hybrid Active	Priority 8
AC Source Input Limit	50.00 kW
Grid Export Limit	5.00 kW
Charge Limit	5.80 kW
AC Load Support Limit	6.00 kW
Battery Charging	Charger Off
Inverter Disconnect Status	Inverter active
Grid Disconnect Status	Grid allowed
Power Override Target	0.00 kW

System Regulation Status	
Solar Hybrid Active	Priority 5
AC Source Input Limit	0.00 kW Recovering
Grid Export Limit	0.20 kW
Charge Limit	6.47 kW
AC Load Support Limit	-0.01 kW Recovering
Battery Charging	Charger Off
Inverter Disconnect Status	Inverter active
Grid Disconnect Status	Grid allowed
Power Override Target	0.00 kW Recovering



## Today Tab

The TODAY tab gives you data about the system for the current day.

The screenshot shows the 'Today' tab in the SELECTRONIC software. The interface includes a menu bar (File, Connection, Performance Data, Help) and a status bar (Connected, 00:06:14, 28/02/2017 - 13:35:50). The main content area is divided into several panels:

- DC Totals:** DC Energy In (6.6 kWh), DC Energy Out (4.0 kWh), DC Energy Net (2.6 kWh), DC Inverter Energy (6.7 kWh), Solar (Shunt 1) Energy (2.6 kWh), Load (Shunt 2) Energy (1.4 kWh), Battery Input Energy (5.3 kWh), Battery Output Energy (2.6 kWh).
- Hours of Float:** 0.0 h, Time that Float was Achieved Today (Not Achieved).
- AC Totals:** AC Load Energy (5.1 kWh), AC Input Energy (0.0 kWh), Hours of AC Input (0.0 h), Inverter Run Time (13.6 h), Export Energy (0.0 kWh).
- DC Peak:** Solar (Shunt 1) Power (1.08 kW), Load (Shunt 2) Power (Not Applicable).
- AC Coupled Solar:** Total Energy (7.3 kWh), Energy #1 (Primo 4.0-1) (Not Applicable), Energy #2 (Primo 3.0-1) (Not Applicable).
- Peak Power:** Not Applicable.

### DC TOTALS

This panel is a summary of today's totals of inputs and outputs through the battery pack. DC ENERGY IN is compared to DC ENERGY OUT to arrive at DC ENERGY NET and the results are recorded in kW hours. DC Inverter Energy is a total of the work the inverter has done, whether that is supplying a load or charging. If you wish to monitor the day to day performance of the system Time That Float Was Achieved Today can be compared with yesterdays in the DC HISTORY tab. This can be a handy comparative reading. You can record daily how long it takes the system to replenish the previous days usage.

### AC TOTALS

This is also a summary page, but this time of the AC kW hours through the system. AC LOAD ENERGY records the total power consumption by the site during that day. AC INPUT ENERGY shows the total contribution by the generator or the mains grid, while HOURS OF AC INPUT records the running time of the generator or the length of time the mains grid was connected to the SP PRO. INVERTER RUN TIME is the length of time the inverter has run today – this should be all the time unless you have programmed in an Inverter Lockout period. In grid connected systems EXPORT ENERGY is the total power the system has contributed to the mains grid in that day.

### DC PEAK

This screen records the peak power level that has passed through the shunt(s) that day. Not Applicable means the shunt isn't configured for measuring renewable.

### AC COUPLED SOLAR

AC Energy (kWh) generated by the Managed AC coupled grid inverters. The Individual energy readings (Energy #1 etc) are not available when ABB grid inverters are used in a managed AC coupled system.

The summary panels provide a quick overview of the system's performance:

- DC Totals:** DC Energy In (0.0 kWh), DC Energy Out (0.0 kWh), DC Energy Net (0.0 kWh), DC Inverter Energy (0.1 kWh), Shunt 1 Energy (Disabled), Shunt 2 Energy (Disabled), Battery Input Energy (0.0 kWh), Battery Output Energy (0.0 kWh).
- AC Totals:** AC Load Energy (4.5 kWh), AC Input Energy (4.5 kWh), Hours of AC Input (11.2 h), Inverter Run Time (0.0 h), Export Energy (2.2 kWh).
- DC Peak:** Shunt 1 Power (1.2 kW), Shunt 2 Power (1.5 kW).
- AC Coupled Solar:** Total Energy (7.7 kWh), Energy #1 (PVI-3.6) (0.0 kWh).



## DC History Tab

The next tab is the DC HISTORY screen. As the name implies this screen gives you data from the previous day, the last seven days, the last 30 days, the last year and the whole period since installation.

The screenshot shows the DC History screen with the following data:

Battery Input Energy		Battery Output Energy		DC Energy Resettable		Hours of Float		Solar (Shunt 1) Energy	
Previous Day's Total	6.8 kWh	Previous Day's Total	4.2 kWh	Total In	3707.6 kWh	Previous Day's Total	3.9 h	Previous Day's Total	5.3 kWh
7 Day Total	44.3 kWh	7 Day Total	34.9 kWh	Total Out	3007.6 kWh	7 Day Total	16.3 h	7 Day Total	35.6 kWh
30 Day Total	210 kWh	30 Day Total	167 kWh	Total Net	699.9 kWh	30 Day Total	49.2 h	30 Day Total	150 kWh
365 Day Total	2357 kWh	365 Day Total	1856 kWh	Reset On	11/10/15	365 Day Total	570.3 h	365 Day Total	1043 kWh
Year to Date Total	393 kWh	Year to Date Total	307 kWh	Reset	[dd/mm/yyyy]	Year to Date Total	93.0 h	Year to Date Total	283 kWh
Year Starting on	01/01	Year Starting on	01/01			Year Starting on	01/01	Year Starting on	01/01
Resettable Total	3129 kWh	Resettable Total	2429 kWh			Resettable Total		Resettable Total	1494 kWh
Total Accumulated	7039 kWh	Total Accumulated	9641 kWh			Total Accumulated		Total Accumulated	1999 kWh

**Battery Input Energy**

Previous Day's Total	2.0 kWh
7 Day Total	22.8 kWh
30 Day Total	97 kWh
365 Day Total	432 kWh
Year to Date Total	30 kWh
Year Starting on	01/01
Resettable Total	910 kWh
Total Accumulated	910 kWh

**Battery Output Energy**

Previous Day's Total	2.5 kWh
7 Day Total	16.3 kWh
30 Day Total	76 kWh
365 Day Total	342 kWh
Year to Date Total	22 kWh
Year Starting on	01/01
Resettable Total	507 kWh
Total Accumulated	507 kWh

All the input to the battery bank

All the output.



DC ENERGY RESETTABLE is like a trip meter in your car. When reset this records DC energy in and out of the system and gives a net total.

RESET ON: shows the date when last reset so you can calculate how many days have elapsed. By clicking the Reset tab all totals in this reading are zeroed and accumulation of data starts again on the date of the reset.

**DC Energy Resettable**

Total In  
910.1 kWh

Total Out  
506.8 kWh

Total Net  
403.1 kWh

Reset On **00/00/00**  
[dd/mm/yyyy]

HOURS OF FLOAT records what time float was achieved on the previous day and how much time has been spent in float since installation.

This data can be used for future system improvement design. If the system never reaches float, you may need to increase the solar array size, if the system regularly enters float before lunch you may be able to consider adding extra "luxury" loads to the system.

**Note:** SoC will be set to 100% when Float Charging Mode is entered.

**Hours of Float**

Previous Day's Total 9.3 h	Previous Day Float Achieved at Disabled
7 Day Total 93.6 h	7 Day Daily Average 13.4 h
30 Day Total 248.3 h	30 Day Daily Average 8.3 h
365 Day Total 6170.6 h	365 Day Daily Average 17.0 h

Year to Date

Total 117.5 h	Daily Average 13.1 h
------------------	-------------------------

Year Starting on **01/01** [dd/mm]

This panel gives a picture of the effect that Shunt 1 has had on the system. For the sake of clarity we will assume that Shunt 1 measures the solar input. This, then, records the solar contribution to the system since the system was installed. Once again you can compare today's solar input with other averages to see if you've had a good or a bad solar day.

As with the previous screen you can collect data over a period you determine with the use of the RESETTABLE feature.

The TOTAL ACCUMULATED is all the solar input to the system since installation.

**Solar (Shunt 1) Energy**

Previous Day's Total 0.0 kWh	Previous Day's Peak Power 0.00 kW
7 Day Total 0.0 kWh	7 Day Daily Average 0.0 kWh
30 Day Total 0 kWh	30 Day Daily Average 0.00 kWh
365 Day Total 0 kWh	365 Day Daily Average 0.00 kWh

Year to Date

Total 0 kWh	Daily Average 0.00 kWh
----------------	---------------------------

Year Starting on **01/01** [dd/mm]

Resettable

Total 0 kWh	Daily Average 0.00 kWh
----------------	---------------------------

Reset on **00/00/00**  
[dd/mm/yyyy]

Total Accumulated  
0 kWh

This panel is the historical record of the Shunt 2 and its effect on the system, either through a renewable contribution, if it is measuring input through a wind turbine or micro hydro, or as a deduction through DC loads. In the case shown, DC Loads.

**Load (Shunt 2) Energy**

Previous Day's Total	Previous Day's Peak Power
0.0 kWh	Not applicable
7 Day Total	7 Day Daily Average
0.0 kWh	0.0 kWh
30 Day Total	30 Day Daily Average
0 kWh	0.00 kWh
365 Day Total	365 Day Daily Average
0 kWh	0.00 kWh

**Year to Date**

Total	Daily Average
0 kWh	0.00 kWh

Year Starting on **01/01** [dd/mm]

**Resettable**

Total	Daily Average
0 kWh	0.00 kWh

Reset on **00/00/00**  
[dd/mm/yyyy]

**Total Accumulated**

0 kWh

This panel shows historical data of all of the DC energy that has passed into or out of the inverter.

This panel also gives you the ability to accumulate this data from a date you determine. By pressing the Reset tab all totals in this reading are zeroed and accumulation of data starts again on the date of the reset.

A particular feature of this panel is the ability to compare the previous days total with the averages over a week, a month or a year.

**DC Inverter Energy**

Previous Day's Total	7 Day Daily Average
4.6 kWh	5.53 kWh
7 Day Total	30 Day Daily Average
39.2 kWh	5.76 kWh
30 Day Total	365 Day Daily Average
174 kWh	2.09 kWh
365 Day Total	
774 kWh	

**Year to Date**

Total	Daily Average
51 kWh	5.68 kWh

Year Starting on **01/01** [dd/mm]

**Resettable**

Total	Daily Average
1417.0 kWh	1.20 kWh

Reset on **00/00/00**  
[dd/mm/yyyy]

**Total Accumulated**

1417 kWh



## AC History Tab

The AC HISTORY SCREEN, as with the DC History screen gives you data from the previous day, the last seven days, the last 30 days, the last year and the whole period since installation

AC Load Energy	AC Input Energy	AC Export Energy	Hours of AC Input
Previous Day's Total: 11.1 kWh	Previous Day's Total: 0.0 kWh	Previous Day's Total: 0.0 kWh	Previous Day's Total: 0.0 h
7 Day Total: 85.1 kWh	7 Day Total: 0.0 kWh	7 Day Total: 0.0 kWh	7 Day Total: 0.0 h
7 Day Daily Average: 12.15 kWh	7 Day Daily Average: 0.00 kWh	7 Day Daily Average: 0.00 kWh	7 Day Daily Average: 0.0 h
30 Day Total: 386 kWh	30 Day Total: 19 kWh	30 Day Total: 0 kWh	30 Day Total: 4 h
30 Day Daily Average: 12.92 kWh	30 Day Daily Average: 0.63 kWh	30 Day Daily Average: 0.00 kWh	30 Day Daily Average: 0.1 h
365 Day Total: 3602 kWh	365 Day Total: 499 kWh	365 Day Total: 0 kWh	365 Day Total: 109 h
365 Day Daily Average: 9.83 kWh	365 Day Daily Average: 1.33 kWh	365 Day Daily Average: 0.00 kWh	365 Day Daily Average: 0.3 h
Year to Date Total: 738 kWh	Year to Date Total: 42 kWh	Year to Date Total: 0 kWh	Year to Date Total: 9 h
Daily Average: 12.99 kWh	Daily Average: 0.70 kWh	Daily Average: 0.00 kWh	Daily Average: 0.2 h
Year Starting on: 01/01	Year Starting on: 01/01	Year Starting on: 01/01	Year Starting on: 01/01
Resetable Total: 95 kWh	Resetable Total: 0 kWh	Resetable Total: 0 kWh	Resetable Total: 0 h
Daily Average: 12.01 kWh	Daily Average: 0.00 kWh	Daily Average: 0.00 kWh	Daily Average: 0.0 h
Reset on: 20/02/17	Reset on: 20/02/17	Reset on: 11/10/15	Reset on: 20/02/17
Total Accumulated: 20943 kWh	Total Accumulated: 3585 kWh	Total Accumulated: 3123 kWh	Total Accumulated: 12543 h

This is a record of the total AC loads presented by the home to the power system.

This is the total AC input contributed by the motor generator or by the mains grid.

**AC Load Energy**

Previous Day's Total: 9.8 kWh

7 Day Total: 76.6 kWh | 7 Day Daily Average: 10.94 kWh

30 Day Total: 615 kWh | 30 Day Daily Average: 20.63 kWh

365 Day Total: 7226 kWh | 365 Day Daily Average: 19.85 kWh

Year to Date Total: 121 kWh | Daily Average: 13.47 kWh

Year Starting on: 01/01

Resetable Total: 24160 kWh | Daily Average: 21.05 kWh

Reset on: 05/11/11

Total Accumulated: 24601 kWh

**AC Input Energy**

Previous Day's Total: 6.9 kWh

7 Day Total: 44.1 kWh | 7 Day Daily Average: 6.24 kWh

30 Day Total: 408 kWh | 30 Day Daily Average: 13.68 kWh

365 Day Total: 5625 kWh | 365 Day Daily Average: 15.43 kWh

Year to Date Total: 74 kWh | Daily Average: 8.14 kWh

Year Starting on: 01/01

Resetable Total: 9318 kWh | Daily Average: 14.87 kWh

Reset on: 19/04/13

Total Accumulated: 17810 kWh

In grid connected systems you can monitor the amount of energy exported to the grid comparing today's total with the last week, month or year.

A record of how many hours the generator has run or for how long the mains grid was connected.

**AC Export Energy**

Previous Day's Total  
3.4 kWh

7 Day Total 102.0 kWh	7 Day Daily Average 14.59 kWh
30 Day Total 521 kWh	30 Day Daily Average 17.47 kWh
365 Day Total 3574 kWh	365 Day Daily Average 9.82 kWh

Year to Date

Total 132 kWh	Daily Average 14.73 kWh
------------------	----------------------------

Year Starting on **01/01** [dd/mm]

Resettable

Total 11035 kWh	Daily Average 9.61 kWh
--------------------	---------------------------

Reset on **05/11/11**  
[dd/mm/yyyy]

Total Accumulated  
11037 kWh

**Hours of AC Input**

Previous Day's Total  
23.9 h

7 Day Total 167.4 h	7 Day Daily Average 24.0 h
30 Day Total 714 h	30 Day Daily Average 24.0 h
365 Day Total 8703 h	365 Day Daily Average 24.0 h

Year to Date

Total 215 h	Daily Average 24.0 h
----------------	-------------------------

Year Starting on **01/01** [dd/mm]

Resettable

Total 27472 h	Daily Average 24.0 h
------------------	-------------------------

Reset on **05/11/11**  
[dd/mm/yyyy]

Total Accumulated  
27481 h

Total AC Coupled Solar Energy input to the system.

**AC Coupled Solar Energy**

Previous Day's Total  
5.6 kWh

7 Day Total 139.8 kWh	7 Day Daily Average 19.99 kWh
30 Day Total 750 kWh	30 Day Daily Average 25.12 kWh
365 Day Total 5218 kWh	365 Day Daily Average 14.31 kWh

Year to Date

Total 187 kWh	Daily Average 20.84 kWh
------------------	----------------------------

Year Starting on **01/01** [dd/mm]

Resettable

Total 15821 kWh	Daily Average 14.94 kWh
--------------------	----------------------------

Reset on **02/02/12**  
[dd/mm/yyyy]

Total Accumulated  
15821 kWh



## Technical Data Tab

The TECHNICAL DATA tab provides you with information relating to maintenance and updating the SP PRO.

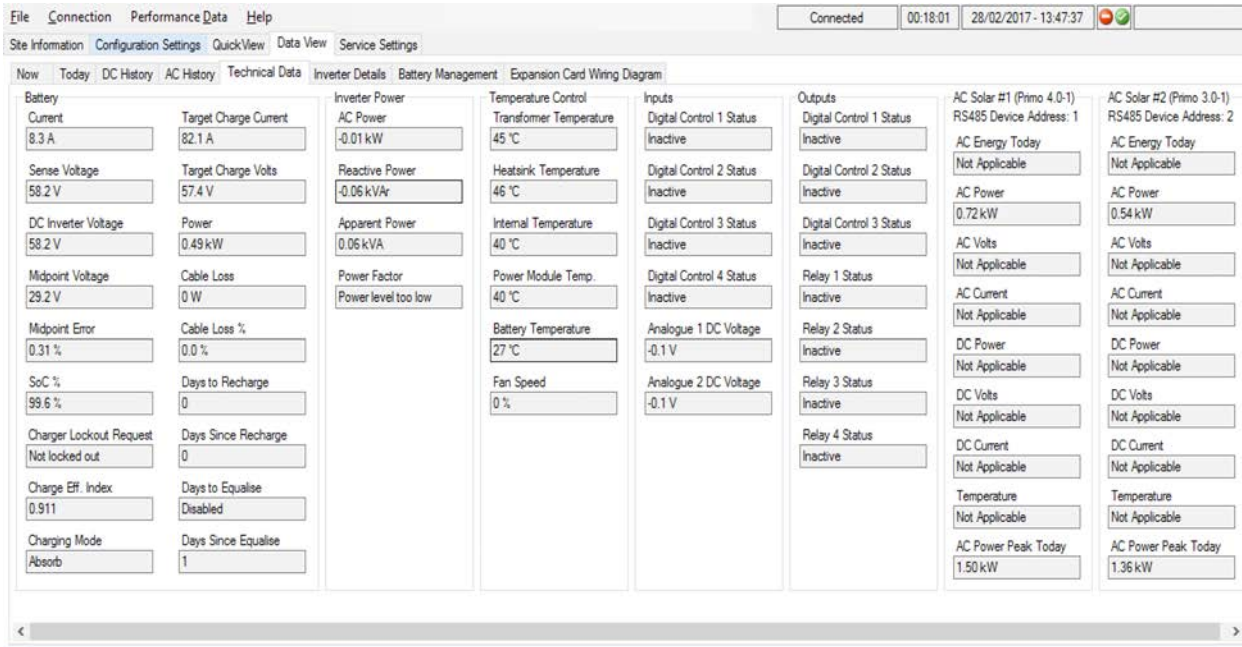

The technical data displayed under BATTERY is described below.

**CURRENT** is a measurement of the current in the battery bank. A positive (+) value, the battery is charging. A negative (-) value, the battery is discharging.

**SENSE VOLTAGE** is a measurement of the battery voltage at the battery terminals (when the battery sense/pre-charge wiring is installed)

**TARGET CHARGE CURRENT** and **TARGET CHARGE VOLTS** Show the present temperature compensated charge current and voltage of the SP PRO battery charger.

**DC INVERTER VOLTAGE** is a measurement of the battery voltage within the SP PRO

**POWER** is the amount of power presently drawn from the battery bank and is used in conjunction with Cable Loss to determine its significance.

**MIDPOINT VOLTAGE** is a measurement of half the battery voltage at the battery terminals (when the battery sense/pre-charge wiring is installed) If this value is not half the Sense Voltage then the batteries need equalising or there is a faulty cell.

**MIDPOINT ERROR** is a measurement of the error in the midpoint voltage as a %.

**CABLE LOSS** is the amount of power that is dissipated in the battery cabling, fusing and terminal system. A high reading could indicate a problem with the battery terminals, battery connection to the SP PRO or inadequate cable sizing.

**CABLE LOSS %** is the Cable loss as a percentage of the Battery power at that time.

**SoC %** is the State of Charge of the battery bank. 100% SoC is a full battery.

**DAYS TO RECHARGE** and **DAYS SINCE RECHARGE** - If Periodic Recharge is enabled these readings track the days since the last battery recharge and how many days before the next battery recharge.

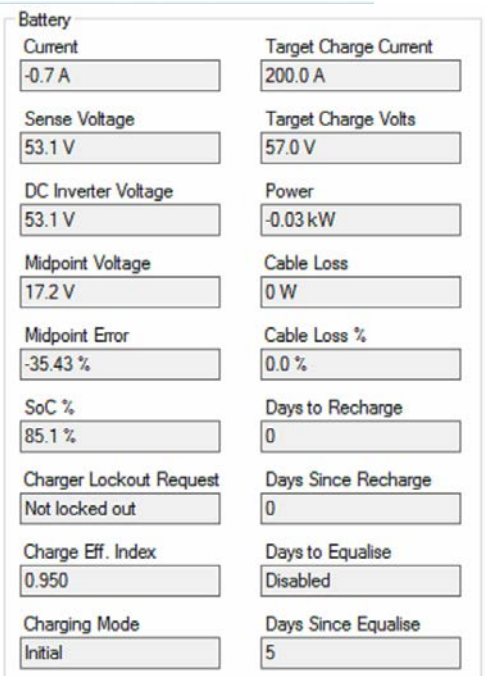

CHARGER LOCKOUT REQUESTED indicates when the charger is off and there is no charging from the SP PRO.

CHARGE EFFICIENCY INDEX is an internally adjusted factor that is used to constantly calibrate the State of Charge calculation within the SP PRO. It also gives an indication of the battery health with a value below 0.8 suggesting that the batteries may need replacing. A normal value is between 0.9 and 1.0

DAYS TO EQUALISE and DAYS SINCE EQUALISE record how long since the batteries received an equalising charge and how long before one is due. When an external charging source raises the battery voltage to the Equalise voltage for the Equalise period the SP PRO will see this as a completed Equalise Charge.

CHARGING MODE shows the stage of battery charger in the SP PRO. This is the same information as shown on the front panel of the SP PRO.

AC POWER is a measurement of the real power being passed through the inverter between the DC sources (Battery bank and DC coupled charging sources) and its AC output. A positive (+) value, the inverter is charging the battery. A negative (-) value, the inverter is supporting the load from the DC sources.

Inverter Power	
AC Power	-0.76 kW
Reactive Power	0.00 kVAr
Apparent Power	0.76 kVA
Power Factor	1.00

REACTIVE POWER is a measure of the VARs being provided by the SP PRO.

APPARENT POWER is a measure of the inverter's AC voltage x AC current (volt amps).

POWER FACTOR is that of the inverter AC output. This is not a measure of the power factor of the load except when the SP PRO is in stand alone (not synchronised to the grid or a generator) and with no AC coupled solar input.

The TEMPERATURE CONTROL panel displays the temperatures of various components within the SP PRO under the present operating conditions. This will assist support personnel to determine the cause of thermally related system issues.

Temperature Control	
Transformer Temperature	38 °C
Heatsink Temperature	43 °C
Internal Temperature	36 °C
Power Module Temp.	37 °C
Battery Temperature	24 °C
Fan Speed	0 %

The INPUTS AND OUTPUTS panel monitors the status of the digital and analogue inputs and outputs. Active is ON and Inactive is OFF.

Inputs	Outputs
Digital Control 1 Status Active	Digital Control 1 Status Active
Digital Control 2 Status Inactive	Digital Control 2 Status Inactive
Digital Control 3 Status Inactive	Digital Control 3 Status Inactive
Digital Control 4 Status Inactive	Relay 1 Status Inactive
Analogue 1 DC Voltage 0.4 V	Relay 2 Status Inactive
Analogue 2 DC Voltage 0.4 V	Relay 3 Status Inactive
	Relay 4 Status Active



The AC Solar panels (#1 through to #5 when connected) display all of the data fed back from each Managed AC coupled grid connect unit.

The “RS485 Device Address” shows the Address that has been configured in that particular grid inverter. For KACO or Fronius inverters this is address 1 to 5 for AC Solar #1 to AC Solar #5 respectively. For ABB inverters the RS485 Device address is 2 to 6 respectively.

When ABB solar grid inverters are connected to the SP PRO, there are 4 readings that are not available from the ABB solar grid inverter. AC Energy today, AC current, DC power and DC current.

When Fronius solar grid inverters are connected to the SP PRO, there are 7 readings that are not available from the Fronius solar grid inverter. AC Energy today, AC Volts, AC current, DC power, DC Volts, DC current and Temperature.

If the SP PRO has lost communications with a grid inverter or the grid inverter has gone to “sleep” at night, the message “Inverter Offline” is displayed in all its readings except AC Power Peak Today

AC Solar #1 (Primo 4.0-1) RS485 Device Address: 1	AC Solar #2 (Primo 3.0-1) RS485 Device Address: 2
AC Energy Today Not Applicable	AC Energy Today Not Applicable
AC Power 0.72 kW	AC Power 0.54 kW
AC Volts Not Applicable	AC Volts Not Applicable
AC Current Not Applicable	AC Current Not Applicable
DC Power Not Applicable	DC Power Not Applicable
DC Volts Not Applicable	DC Volts Not Applicable
DC Current Not Applicable	DC Current Not Applicable
Temperature Not Applicable	Temperature Not Applicable
AC Power Peak Today 1.50 kW	AC Power Peak Today 1.36 kW

## Inverter Details Tab

The INVERTER DETAILS tab provides you with information about the SP PRO.

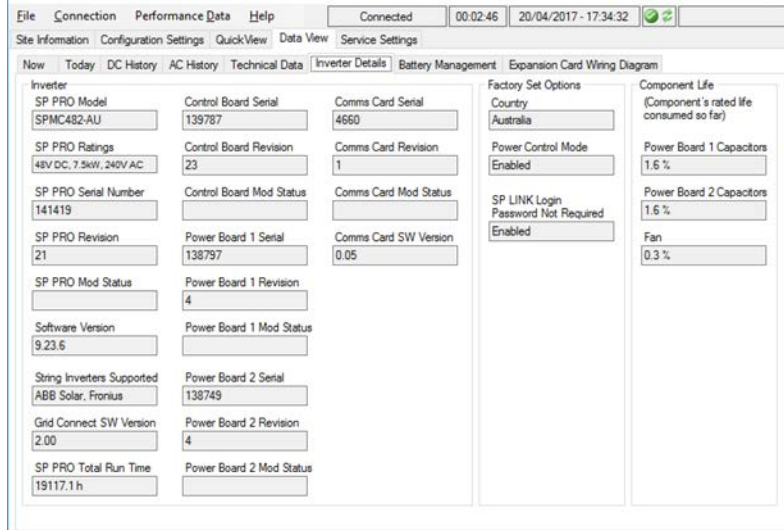

In the INVERTER section we show you the SOFTWARE VERSION and hardware that is currently installed in the inverter. From time to time, as Selectronic designs new features for the SP PRO, new revisions of software may become available from our web site. Generally, there is no need to update the SP PRO unless you need the new features made available.

TOTAL RUN TIME tells you the total number of hours the inverter has run.

If the SP PRO is fitted with an Advanced Comms Card (ACC) then the card's serial number, hardware revision and firmware revision is recorded under COMMS PCA SERIAL. Otherwise this section is greyed out.

FACTORY SET OPTIONS displays the configurations that have been set in the factory. These settings cannot be changed.

The SP PRO monitors the life-span of certain components within the inverter. By advising you of the amount of CAPACITOR LIFE and FAN LIFE that have been consumed SP LINK allows you to plan for long term maintenance at a time that will not inconvenience you.

<b>Inverter</b>	
SP PRO Model	Control Board Serial
SPMC482-AU	139787
SP PRO Ratings	Control Board Revision
48V DC, 7.5kW, 240V AC	23
SP PRO Serial Number	Control Board Mod Status
141419	
SP PRO Revision	Power Board 1 Serial
21	138797
SP PRO Mod Status	Power Board 1 Revision
	4
Software Version	Power Board 1 Mod Status
9.23.6	
String Inverters Supported	Power Board 2 Serial
ABB Solar, Fronius	138749
Grid Connect SW Version	Power Board 2 Revision
2.00	4
SP PRO Total Run Time	Power Board 2 Mod Status
19117.1 h	
Comms Card Serial	
4660	
Comms Card Revision	
1	
Comms Card Mod Status	
Comms Card SW Version	
0.05	
<b>Factory Set Options</b>	
Country	Component Life (Component's rated life consumed so far)
Australia	
Power Control Mode	Power Board 1 Capacitors
Enabled	1.6 %
SP LINK Login Password Not Required	Power Board 2 Capacitors
Enabled	1.6 %
	Fan
	0.3 %

## Battery Management Tab

If the SP PRO is connected to and communicating with a battery that has a Battery Management System (BMS) then the BATTERY MANAGEMENT tab provides you with the available battery information.

The BATTERY MANAGEMENT section shows information about the entire battery bank whilst the MODULE STATUS section displays information about the individual battery modules within the battery bank

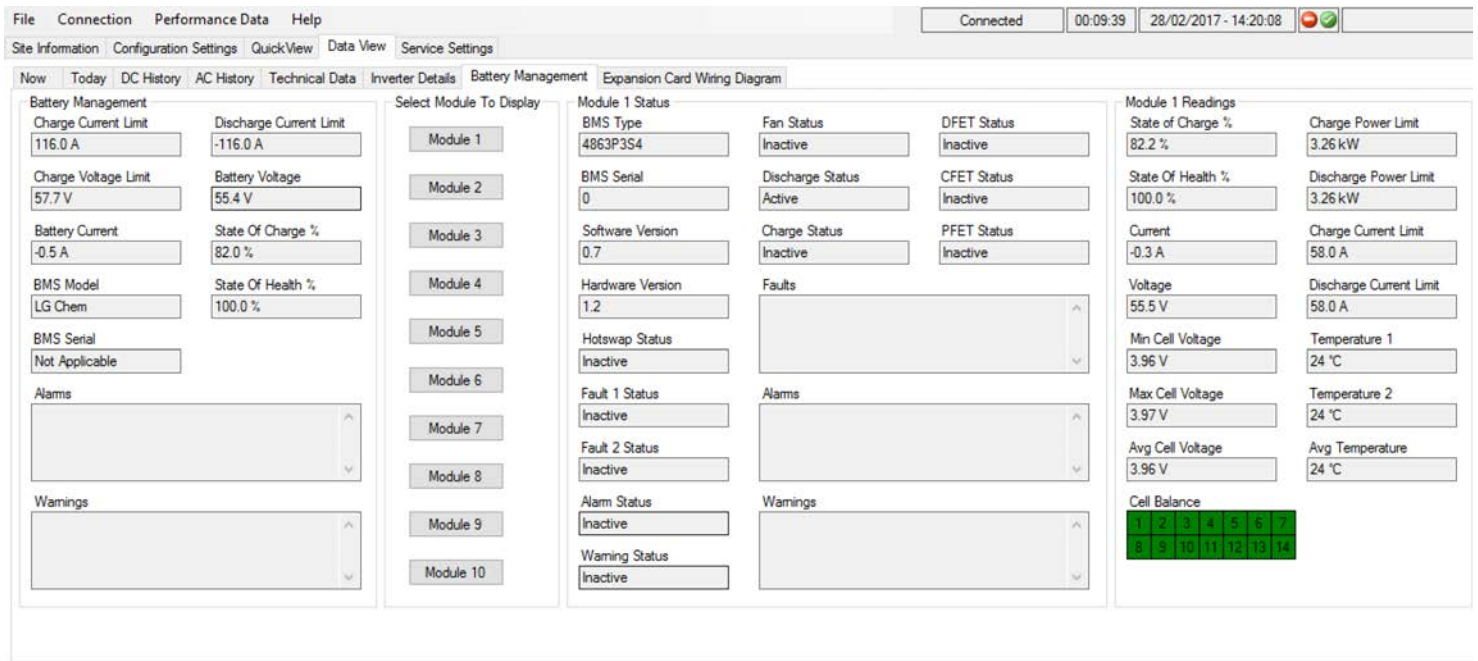

The screenshot shows the 'Battery Management' tab in a software interface. It includes a menu bar (File, Connection, Performance Data, Help) and a status bar (Connected, 00:09:39, 28/02/2017 - 14:20:08). The main content area is divided into several sections:

- Battery Management:** Displays Charge Current Limit (116.0 A), Discharge Current Limit (-116.0 A), Charge Voltage Limit (57.7 V), Battery Voltage (55.4 V), Battery Current (-0.5 A), State Of Charge % (82.0 %), BMS Model (LG Chem), State Of Health % (100.0 %), BMS Serial (Not Applicable), Alarms, and Warnings.
- Select Module To Display:** A list of modules from Module 1 to Module 10.
- Module 1 Status:** Shows BMS Type (4863P3S4), BMS Serial (0), Software Version (0.7), Hardware Version (1.2), Hotswap Status (Inactive), Fault 1 Status (Inactive), Fault 2 Status (Inactive), Alarm Status (Inactive), and Warning Status (Inactive).
- Fan Status:** Inactive.
- DFET Status:** Inactive.
- CFET Status:** Inactive.
- PFET Status:** Inactive.
- Charge Status:** Inactive.
- Discharge Status:** Active.
- Faults:** A scrollable list of faults.
- Alarms:** A scrollable list of alarms.
- Warnings:** A scrollable list of warnings.
- Module 1 Readings:** Shows State of Charge % (82.2 %), Charge Power Limit (3.26 kW), State Of Health % (100.0 %), Discharge Power Limit (3.26 kW), Current (-0.3 A), Charge Current Limit (58.0 A), Voltage (55.5 V), Discharge Current Limit (58.0 A), Min Cell Voltage (3.96 V), Temperature 1 (24 °C), Max Cell Voltage (3.97 V), Temperature 2 (24 °C), Avg Cell Voltage (3.96 V), Avg Temperature (24 °C), and Cell Balance (a 2x6 grid of values).

**Charge Current Limit:** The maximum charge current allowed at the time

**Discharge Current Limit:** The maximum discharge charge current allowed at the time

**Charge Voltage Limit:** The maximum charge voltage allowed at that time

**Battery Current:** The battery current at that time. Positive current is charging, negative is discharging.

**State of Charge:** The battery SoC as read from the BMS.

**BMS Model:** The model number of the BMS or battery connected to the SP PRO

**State of Health** Indicates how much of the battery has been used.

**Alarms and Warnings:** Displays any alarms or warnings generated by the BMS.

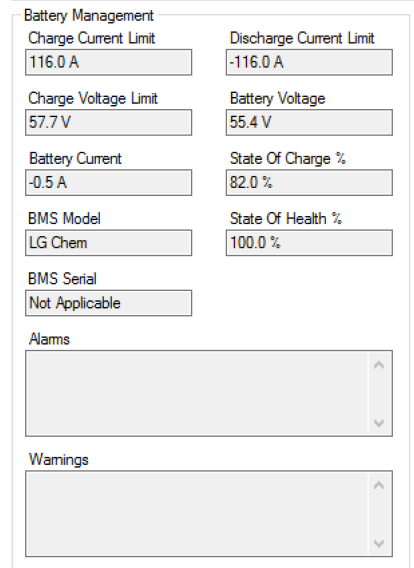

This is a detailed view of the 'Battery Management' section. It shows the following parameters:

- Charge Current Limit: 116.0 A
- Discharge Current Limit: -116.0 A
- Charge Voltage Limit: 57.7 V
- Battery Voltage: 55.4 V
- Battery Current: -0.5 A
- State Of Charge %: 82.0 %
- BMS Model: LG Chem
- State Of Health %: 100.0 %
- BMS Serial: Not Applicable
- Alarms: (Empty scrollable list)
- Warnings: (Empty scrollable list)

## MODULE STATUS

The module status section provides advance diagnostic information about the battery system and is used for advanced diagnoses of any faults. It is only available when there are more than one battery module connected into the system and when the BMS has the facility to provide the information. This section is greyed out when this information is not available from the BMS.

## Expansion Card Wiring Diagram Tab

The Expansion Card Wiring Diagram shows you how the input and output functions are programmed and allocated in the SP PRO. This display is only active when the are connected to the SP PRO.

Now
Today
DC History
AC History
Technical Data
Expansion Card Wiring Diagram

Battery Voltage

Solar

Load

Battery Temperature Sensor  
(Non-Programmable Input)

Analogue Control

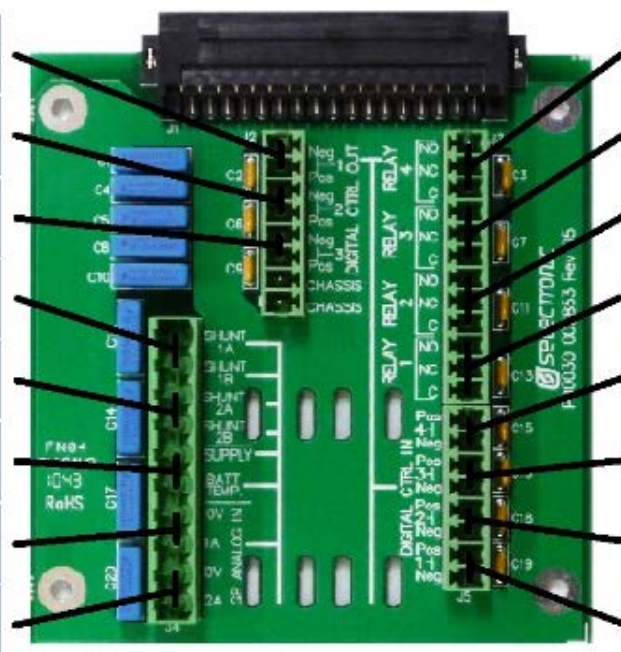

Generator Run

**Unused Features**

Generator Start, Initial Stage, Bulk Stage, Absorb Stage, Float Stage, Equalise Stage, Timed Assert, Battery SoC, Digital Control, Analogue Control, Alarm, AC Load Energy, AC Load Power, Initial Stage, Bulk Stage, Absorb Stage, Float Stage, Equalise Stage, Generator Fault, Generator Low Fuel, Generator No Fuel, Generator Available, Digital Control, Normal/Alternate AC Input Power Se, High Battery Alert , External AC Contactor Control, Low Batt Shut Down Override,
↑

↓

Change Expansion Card Type

The Unused Features display lists all input and output functions that have not been allocated to an input or output.

Expansion card picture may vary depending on SP PRO model. Click Change Expansion Card Type to suit the model.



Blank Page

# Service Settings



Certain readings within the SP PRO must be correctly configured at the time of the original setup. These include the time and date, an approximation of the state of charge and that the current shunts are zeroed.

The screenshot displays the 'Service Settings' page of the SP PRO interface. The top navigation bar includes 'File', 'Connection', 'Performance Data', and 'Help'. The status bar shows 'Connected', '00:02:09', and '02/10/2017 - 13:40:01'. The main content area is divided into several panels:

- Set SP PRO date/time:** Includes fields for 'SP PRO's Present Date and Time' (Date: 02/10/2017, Time: 13:40:01) and options to 'Use Computer Date and Time with Offset' (Offset: 00:00) or 'Manually Set Date and Time' (SP PRO Date: 13/08/2009, SP PRO Time: 14:37).
- Reset SoC:** Shows 'Present SoC' at 89.0% and 'New SoC' at 1.0 - 99.9%.
- Shunts:** Configures 'Shunt 1 Current' and 'Shunt 2 Current', both currently 'Disabled'.
- Fan:** Sets 'Present Fan Type' to 0 and 'New Fan Type' to [0 - 0].
- Settings Passcode:** Shows 'Type New Passcode' as [1 - 65535] and 'Retype New Passcode'.
- AC Input Safety Monitor:** Shows 'Present Monitor State' as 'Enabled' and 'New Monitor State' as 'Disabled'.
- Battery Equalise:** Shows 'Present Equalise State' as 'No Equalise Pending' and 'Change Equalise State'.
- Charge Efficiency Index:** Shows 'Present Value' at 0.950 and 'New Value' at 0.950.
- Sync Overload Shutdown:** Shows 'Present Grid Quality' as 'Poor' and 'New Grid Quality' as 'Normal'.
- Scheduled Restart:** Shows 'Present Schedule' as 'Disabled' and 'New Schedule' as 14:37.
- AC Solar Link Test:** Includes a warning about 'E-N DISCONNECT' and a 'Reset Counters' button.
- Installer Only Service Settings:** Includes an 'Unlock' button and 'Export Limit' settings (Present: No Limit, New: 5000.0).
- Total Support Limit:** Shows 'Present Value' at 5.0 kW and 'New Value' at 5000.0.



## Time and date

To ensure that various timed functions within the SP PRO, such as generator run schedules, perform as expected it is important to have the correct date and time recorded in the SP PRO. You have the option of automatically uploading the time and date from the computer – including the facility to allow for an offset if the computer is set to a different time zone to the area of installation – or to manually set the time and date.

If you are adjusting the date manually click on the circle adjacent to MANUALLY SET DATE / TIME and use the drop down menu to select the correct date. The time can be set by clicking on the hour or minute section and use the up/down arrows to adjust.

When you have completed adjustment click on SET SP PRO TIME to record the change.

Set SP PRO date/time

**SP PRO's Present Date and Time**

Date [dd/mm/yyyy]  
26/07/2014

Time [hh:mm]  
14:31:00

Use Computer Date and Time with Offset

**Offset**  
[hh:mm]  
00:00

Manually Set Date and Time

**SP PRO Date**  
[dd/mm/yyyy]  
13/08/2009

**SP PRO Time**  
[00:00 - 23:59]  
14:27

Set SP PRO Time

## Battery SoC

When first setting up the SP PRO an initial estimation of the state of charge must be programmed to enable the SP PRO to facilitate all the functions that are determined by the state of charge measurement from the first day. As the period of operation increases any small error from the original estimation will be corrected. This function is not used when the SP PRO is communicating with a battery as the SoC is read directly from the BMS.

Reset SoC

**Present SoC**  
59.7%

**New SoC**  
[1.0 - 99.9%]  
85.0

Set SoC

## Expansion Card

The current status of the EXPANSION CARD is displayed. The SP PRO can be set to use (Enabled) all the connected functions from the expansion card like shunts and battery temperature sensor or to ignore (Disabled) them. By default the Expansion Card is enabled.

Expansion Card

**Present State**  
Enabled

**New State**  
[Enabled, Disabled]  
Enabled

Set Exp. Card State

## Settings Passcode

The SETTINGS PASSCODE is only used to change configuration settings within the SP PRO. A separate passcode (Login Passcode) is used to connect to the SP PRO.

If you are concerned that the standard SETTINGS PASSCODE does not provide the level of security you desire for changing settings, you can change the passcode in the SP PRO to one that is uniquely yours.

Please note that if this Settings Passcode is lost or forgotten it can only be reset by a procedure that requires someone to be on site.

If you require assistance resetting the passcode please consult a Selectronic Accredited Integrator.

Settings Passcode

**Type New Passcode**  
[1 - 65535]

**Retype New Passcode**

Set Passcode

## Zero Shunts

To accurately measure and calculate inputs and outputs to and from the batteries the SP PRO needs to start its measurements knowing what is Zero. To set this parameter you must ensure all inputs and outputs are switched off – that is no solar, wind or other inputs coming into the system and all DC loads are switched off – then the ZERO SHUNT 1 and ZERO SHUNT 2 buttons should be pressed.

The figures above the buttons indicate what the on board computer in the SP PRO perceives the relative current to be before zeroing.

Shunts

**Shunt 1 Current**  
(Shunt 1)  
Disabled

Zero Shunt 1

**Shunt 2 Current**  
(Shunt 2)  
Disabled

Zero Shunt 2

## Fan Type

The cooling fan within the SP PRO is a long life, high quality component. As the control section of the SP PRO calculates the hours of life left in the fan (along with other components) it is important that the fan – when it is eventually necessary – is replaced by an authorised spare part. However we are aware that components become obsolete and other fans may need to be used, so we have allowed settings for 4 different fan types. These settings are based around all the fan types available at this time and we will clearly mark any replacement fans with their fan type as they become available.

Fan

**Present Fan Type**  
0

**New Fan Type**  
[0 - 0]

0

Set Fan Type

**Fan Life**  
0.0 %

Reset Fan Life

## AC Safety Monitor

The AC INPUT SAFETY MONITOR detects the loss of the earth/neutral link in the AC Source input to the SP PRO and instantly disconnects the SP PRO from the AC source whether it be a generator or the mains grid. This important safety feature is included as secondary protection when the AC source is connected via a removable plug to the generator or mains grid.

NOTE: The primary protection for a plug in AC source must be a shrouded plug that prevents contact with the plug terminals when removed from the socket.

This feature should only be disabled if the AC Source is hard wired to the SP PRO and the wiring configuration will trip the AC Safety Monitor. To disable this feature:

1. Set the New Monitor State to Disabled then click Set Monitor State. Present Monitor state will change to Enabled.
2. Set the EN - DISCONNECT switch within the SP PRO to Disable (DS). The State of Actual Switch field will change to Disabled

AC Input Safety Monitor

**Present Monitor State**  
Enabled

**New Monitor State**  
[Enabled, Disabled]

Disabled

Set Monitor State

State of Actual Switch  
Enabled



Never disable this feature unless the AC Source is hard wired to the SP PRO..



## Request Battery Equalise

The BATTERY EQUALISE display shows whether the SP PRO will perform an equalise charge when it next achieves Float (Equalise Pending). Pressing the button will toggle between Equalise Pending and No Equalise Pending. Pressing the button will also stop a current Equalise process.

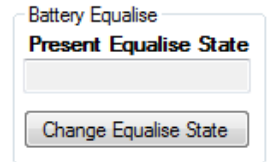

Battery Equalise  
**Present Equalise State**

## Login Password

The LOGIN PASSWORD is only used when connecting to the SP PRO. A separate password is used to change configuration settings (Settings Password). If you are concerned that the default login password does not provide the level of security for any access to the SP PRO, you can change the Login Password in the SP PRO to one that is uniquely yours.

Like the Settings Passcode, if the Login Password is lost or forgotten it can only be reset by a procedure that requires someone to be on site.

SP LINK will automatically update the Connection settings in Site Information when you set the new Login Password.

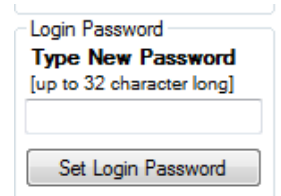

Login Password  
**Type New Password**  
 [up to 32 character long]

## AC Solar Link Test

Used for commissioning or diagnostic of the communications link between the Selectronic Certified grid inverter(s) and the SP PRO in a managed AC coupled installation. AC solar Link Test provides a count of any errors in the link.

When the system installation is complete and all inverters are powered up and running, click “Reset Counters” then wait for 5 minutes. All connected grid inverters should ideally read 0 showing there are no issues with the communications link. A link error count of 4 or less per minute is acceptable although it is recommended that the installation be checked to ensure there are no underlying issues such as the incorrect setting of the RS485 termination resistor on either the SP PRO or grid inverters.

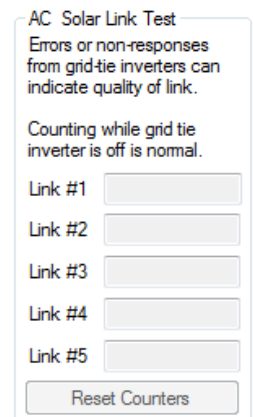

AC Solar Link Test  
 Errors or non-responses from grid-tie inverters can indicate quality of link.  
 Counting while grid tie inverter is off is normal.  
 Link #1   
 Link #2   
 Link #3   
 Link #4   
 Link #5

## Setting Charge Efficiency Index

The Charge Efficiency Index will automatically adjust itself in the SP PRO but a number of faults in the installation could cause it to become erroneous (including poorly calibrated or installed DC current shunt or failing batteries). For a correctly installed system with new batteries the index should be between 0.900 and 1.000. If it is a long way out of range, rectify the system fault then reset it back to 0.950.

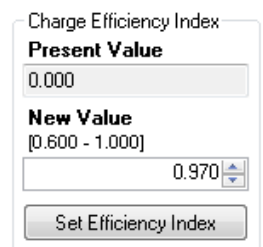

Charge Efficiency Index  
**Present Value**  
 0.000  
**New Value**  
 [0.600 - 1.000]

## Setting For Poor Grid Quality

When the SP PRO is connected and synchronised to an external AC source (grid or generator), it is actively improving the quality of the AC source waveform. If the AC source waveform is particularly distorted then the SP PRO may shutdown from a “Synchronous Overload Shutdown” condition. Setting the **Grid Quality** to **Poor** or **unmonitored** will reduce the sensitivity to this distortion and allow the SP PRO to operate as normal.

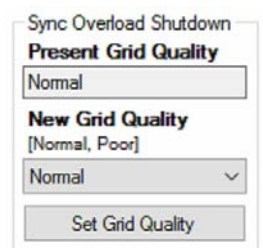

Sync Overload Shutdown  
**Present Grid Quality**  
 Normal  
**New Grid Quality**  
 [Normal, Poor]

### Schedule Restart

Sets the time when the SP PRO will perform an internal restart. This is normally used in Off Grid systems, after new firmware has been loaded into the SP PRO. A restart would normally cause loss of power so this can be set to occur at a time that is least convenient to the customer, say 2:00 am.

Scheduled Reset

**Present Schedule**

**New Schedule**  
[00:00 - 23:59]

06:08 ⬇

Change Schedule

### Installer Only Service Settings

The settings in this group can be changed **WITHOUT** an **Installer Only Code** if this is done within the first four (4) hours of the SP PRO operation.

Normally these settings are configured at installation and would remain unchanged. If a change is required after the system has been running for longer than four hours, an **Installer Only Code** is required. Once entered, the code unlocks these settings for 5 minutes. A code is available from Selectronic to bona fide installers **ONLY**.

**ANTI ISLANDING SENSITIVITY** reduces the active anti islanding threshold in the SP PRO to provide compatibility with some off grid and micro grid systems. This setting must never be changed for grid connected systems that require AS4777.2-2015 compliance.

The active anti islanding can be turned off completely by setting the value to 0%.

**TOTAL SUPPORT LIMIT** limits the maximum total power that can be taken from the battery plus the managed AC Coupled Solar to support the customer's load.

For example, if **TOTAL SUPPORT LIMIT** is set to 5.0kW and there is 3kW of Solar being produced at the time, only 2kW of support power will be available from the battery, giving a total of 5.0kW

**EXPORT LIMIT** is the same function as a Factory Set Export Limit with the exception that it can be set by the installer. If the **EXPORT LIMIT** is set higher than any Factory Set Export Limit then the latter will apply.

Installer Only Service Settings

These settings are accessible for the first four hours of inverter run time, after which access is by a code made available only to installers.

**Installer Only Code**

Unlock

Anti-Islanding Sensitivity

**Present Value**

100 %

**New Value**  
[0 - 100%]

100 ⬇

Set Sensitivity

Export Limit

**Present Value**

No Limit

**New Value**  
[0.0 - 5,000.0]

5000.0 ⬇

Set Export Limit

Total Support Limit

**Present Value**

5.0 kW

**New Value**  
[0.0 - 5,000.0]

5000.0 ⬇

Set Support Limit



# Appendix One Alert Messages



The SP PRO is continuously measuring and monitoring the power system to ensure correct system operation at all times. When the SP PRO detects a problem with the power system it then:

1. Displays a message in the “Attention Required” area in SP LINK (In the Data View - Now tab).
2. Creates an entry in its data log memory. This data can be downloaded from the SP PRO and viewed in the EVENTS tab of the Performance Data Viewer.

The table in this section outlines all the SP PRO ALERT type event messages, the most likely cause and possible remedies.

NOTE: Only the ALERT events are listed - They are listed in alphabetical order.

<b>Alerts and attention required messages</b>	<b>Meaning and diagnostic</b>	<b>Action</b>	<b>Configuration settings&gt;</b>
AC Source - Safety Monitor Alert - Neutral and Earth are not at same potential	The inverter has detected either a poor EN connection or missing EN connection in the AC source wiring.	Call system installer to check the voltage between the Earth and Neutral of the AC source connections at the Inverter. If voltage > 1VAC then track down the wiring fault.	Service Settings > AC Input Safety Monitor (group).
AC Source - Safety Monitor Alert cleared	Above condition has cleared		
Battery - Hi Battery Alert	Battery voltage has risen above the Hi Battery Alert Voltage	Call system installer to check the correct operation of any DC charge controllers. Check communications between SP PRO and grid inverter in Managed AC coupled system. Check all battery system connections and check for faulty cells in battery bank.	Battery > Hi Battery Alert
Battery - Hi Battery Alert Clear	Battery voltage has dropped below the Hi Battery Alert Clear Voltage clearing the above condition		Battery > Hi Battery Alert Clear

Alerts and attention required messages	Meaning and diagnostic	Action	Configuration settings>
Battery - Mid Point Fault - Outside Range after Equalise	Battery Mid Point Voltage is outside Mid Point Range after an equalise has been performed. Battery bank may have faulty cell.	Call installer to check for faulty cells in the battery bank or for poor battery connections between cells and between battery bank and SP PRO	Battery > Midpoint Monitoring
Battery - Mid Point Fault cleared	Above condition has cleared		
Battery - Outside Mid Point Range	Battery Mid Point Voltage is outside Mid Point Range. Battery bank may have faulty cell or need equalise	Initiate an equalise charge from the Service Settings tab in SP LINK (Battery Equalise section). If problem persists then call installer to check for faulty cells in the battery bank or for poor battery connections between cells and between battery bank and SP PRO.	Battery >- Mid Point Range.
Battery - Within Mid Point Range	Above condition has cleared		Battery > Mid Point Range.
Battery - Over Temp Protection Alert	The battery temperature has risen above the Over Temp Protection limit	Immediately turn SP PRO to IDLE (long press of ON button on front panel). Call installer to check battery temperature sensor is correctly installed, batteries charge parameters are correct and that all charging sources are operating correctly. Installer to check that there are no faulty cells in the battery bank and to take measures to reduce battery ambient temperature.	Battery > Over Temp Protection > Limit Charge Above.
Battery - Over Temp Protection Alert cleared	The battery temperature has dropped below the Over Temp Protection limit		Battery > Over Temp Protection > Limit Charge Above..
Battery Management - Alarm	The Battery Management System within the battery has sent an alarm to the SP PRO		
Battery Management - Alarm Cleared	The above alarm has cleared	Look in the Data View > Battery Management tab for details about the fault.	
Charger - Battery Capacity Alert - Provided 120% Capacity and voltage target not achieved	Battery is not charging as fast as expected. The battery SoC has risen but the battery voltage is not matching the expected SoC	Call your installer to check battery condition and for shorted or weak cells.	Battery Capacity
Charger - Battery Capacity Alert cleared - Voltage target achieved	The expected battery voltage target has now been achieved. Batteries now charging as expected.		
Generator Controller - Generator Fault Alert - Stop generator	The Generator Fault input has been asserted. Generator will be stopped if it is running	Call appropriately qualified personnel to diagnose and rectify the generator fault.	Inputs/Outputs > Generator fault input
Generator Controller - Generator Fault Alert cleared	The Generator Fault input has been cleared. Generator will start again as required		Inputs/Outputs - Generator fault input
Generator Controller - Low Fuel Alert	The Generator Low Fuel input has been asserted. Generator will continue to run	Fill generator fuel tank.	Inputs/Outputs - Generator Low Fuel input



Alerts and attention required messages	Meaning and diagnostic	Action	Configuration settings>
Generator Controller - Low Fuel Alert cleared	The Generator Low Fuel input has been cleared		Inputs/Outputs - Generator Low Fuel input
Generator Controller - No Fuel Alert - Stop generator	The Generator No Fuel input has been asserted. Generator will be stopped if it is running	Fill generator fuel tank	Inputs/Outputs - Generator No Fuel input
Generator Controller - No Fuel Alert cleared	The Generator No Fuel input has been cleared. Generator will start again as required		Inputs/Outputs - Generator No Fuel input
Generator Controller - Stopped due to no AC Volts Fault	The Inverter has stopped the generator as there is no AC volts present at the inverter. Caused by either a wiring fault, tripped CB or faulty generator.	Call your installer or appropriately qualified personnel to check the AC source voltage at the SP PRO when the generator is running. If no voltage is present, then they need to trace the voltage back to the generator to find the wiring fault.	
Generator Controller - Stopped due to no AC Volts Fault Cleared	Above condition has cleared		
Inverter - AC Source out of phase On	Only applies to three phase or Split phase systems. The phase rotation or phase sequence on the AC source input is incorrect. Caused by wiring fault on the AC source input - Phase rotation or phase angle is incorrect.	Call your installer or appropriately qualified personnel to check all AC source wiring and AC source supply for correct voltage, phase and phase rotation.	
Inverter - AC Source out of phase Off	Above condition has cleared		
Inverter - AC Source out of tolerance Beeper On	When the AC Source Disconnect Beeper is enabled and the AC source is outside the set limits (as set in AC Source > AC Input tab setting) this alarm will be raised	Normal operation. Alerting the user that the grid supply has either failed or it is too high or too low.	System > AC Source Disconnect Beeper
Inverter - AC Source out of tolerance Beeper Off	Above condition has cleared		
Inverter - DC Shutdown	Inverter has shut down from Low Battery Voltage	Firstly, reduce all the loads on the system to the minimum. Check that all the charging sources such as PV solar and generator charging are functioning correctly. Call installer to check for faulty cells in the battery bank or for poor battery connections between cells and between battery bank and SP PRO	Inverter-DC shutdown (group) > Inverter 0% load and Inverter 100% Load
Inverter - DC Shutdown cleared - Recovery Voltage reached	The battery voltage has risen above the shut down voltage to the Recovery Voltage		Inverter-DC shutdown (group) > Recovery Voltage
Inverter - Low AC Alert	The AC output of the inverter is low, normally due to power overload. Inverter shutdown is imminent.	Start turning off loads and if problem persists with little or no load on the system, call your installer to check for overload or short circuits on the AC load circuits.	





<b>Alerts and attention required messages</b>	<b>Meaning and diagnostic</b>	<b>Action</b>	<b>Configuration settings&gt;</b>
Inverter - Low AC Alert cleared	The AC output of the inverter is now OK. Inverter will not shutdown.		
Inverter - Low AC Shutdown	The AC output of the inverter was low, normally due to power overload and Inverter has shutdown	Start turning off loads and if problem persists with little or no load on the system, call your installer to check for overload or short circuits on the AC load circuits.	
Inverter - Low AC Shutdown cleared	The AC output of the inverter is now OK. Inverter will start again.		
Inverter - Low Battery Voltage Alert	Battery voltage getting close to Shutdown voltage and shutdown is imminent.	Firstly, reduce all the loads on the system to the minimum. Check that all the charging sources such as PV solar and generator charging are functioning correctly. If problem persists, call installer to check for faulty cells in the battery bank or for poor battery connections between cells and between battery bank and SP PRO	Inverter-DC shutdown (group) > Inverter 0% load and Inverter 100% Load
Inverter - Low Battery Voltage Alert cleared	The battery voltage has risen above the to Recovery Voltage		Inverter-DC shutdown (group)
Inverter - Low SoC Alert	Battery SoC is getting close to Shutdown voltage and shutdown is imminent. The loads on the system maybe exceeding the charging source	Firstly, reduce all the loads on the system to the minimum and start your generator. Check that all the charging sources such as PV solar and generator charging are functioning correctly.. If there is a problem with one of the charging sources then contact your installer. If all is OK then you will need to use less power or run the generator more often.	Inverter-DC shutdown (group) > Shutdown SoC
Inverter - Low SoC Alert Cleared	The battery SoC and voltage has risen above the to Recovery level		Inverter-DC shutdown (group) > Shutdown SoC and Recovery Voltage
Inverter - Shutdown Input Active	When programmed within the SP PRO, this input is active and the inverter is shutdown and is not producing any AC output.	Determine the source of the input and remedy the fault within that source	Input / Outputs > Shutdown Input
Inverter - Shutdown Input Active Cleared	The Shutdown input is no longer inactive and the inverter will come back on.		
Inverter - SoC Shutdown	Inverter has shut down from Low SoC	Firstly, reduce all the loads on the system to the minimum and start your generator. Check that all the charging sources such as PV solar and generator charging are functioning correctly. If there is a problem with one of the charging sources then contact your installer. If all is OK then you will need to use less power or run the generator more often.	Inverter-DC shutdown (group) > Inverter 0% load and Inverter 100% Load

Alerts and attention required messages	Meaning and diagnostic	Action	Configuration settings>
Inverter - SoC Shutdown cleared	The battery SoC and voltage has risen above the to Recovery level		Inverter-DC shutdown (group) > Recovery Voltage
Service - AC Source Safety Monitor State does not match State of Actual Switch	The AC safety monitor switch in the inverter does not match the setting in the Service Settings.	Contact your installer to either change to position of the safety monitor switch or change the setting in the Service Settings using SP LINK	Service Settings > AC Input Safety Monitor (group).
Service - AC Source Safety Monitor State matches State of Actual Switch	Above condition has cleared		
Service - Fan Alert - Fan not spinning	Cooling Fan is not spinning due to obstruction or failure	Power down the SP PRO inverter following the shutdown procedure provided beside the inverter. Remove fan guard and check fan for obstructions. Check fan can spin freely. If problem persists, contact your installer to install a new fan.	-
Service - Fan Alert cleared - Fan spinning or not required	Cooling Fan is now spinning again.		
Service - Fan Filter Alert - Clean Filter	Recommend that the cooling fan filter be cleaned to maintain cooling efficiency	Clean fan filter in the base of the unit with a soft brush to remove any dirt or obstruction.	
Service - Fan Filter Alert cleared - Filter clean button pressed	Above condition has cleared		
Service - Fan Life Alert - Life at or above 100% - Replace Fan	Recommend that the cooling fan be replaced to prevent unexpected failure.	Contact your installer for a replacement fan.	
Service - Fan Life Alert cleared - Life reset to 0.	Above condition has cleared		
Service - Fan Speed Alert - Speed lower than expected - Check Fan	Cooling fan is running too slow. Check for fan fault or obstruction.	Clean fan filter in the base of the unit with a soft brush to remove any dirt or obstruction. If problem persists then power down the SP PRO inverter following the shutdown procedure provided beside the inverter. Remove fan guard and check fan for obstructions. Check fan can spin freely. If problem still persists, contact your installer to install a new fan.	
Service - Fan Speed Alert cleared - Speed as expected	Above condition has cleared		
Service - Power Module 1 Capacitor Life Alert - Life at or above 95%	The internal capacitors have reach the end of their rated life. Recommend inverter returned to Service for capacitor upgrade.	Contact Selectronic service at <a href="http://www.selectronic.com.au/service/">http://www.selectronic.com.au/service/</a>	
Service - Power Module 1 Capacitor Life Alert cleared	Above condition has cleared		



Alerts and attention required messages	Meaning and diagnostic	Action	Configuration settings>
Service - Power Module 2 Capacitor Life Alert - Life at or above 95%	The internal capacitors have reach the end of their rated life. Recommend inverter returned to Service for capacitor upgrade.	Contact Selectronic service at <a href="http://www.selectronic.com.au/service/">http://www.selectronic.com.au/service/</a>	
Service - Power Module 2 Capacitor Life Alert cleared	Above condition has cleared		
System - AC coupled frequency ramp invoked	1. Managed AC coupled system - Indicates loss of control so Inverter ramps its output frequency to 55 Hz to cause a AS4777 disconnect to "kick off" the AC Coupled Inverters	Remove all connections to the AC load terminals. If Alert persists then inverter has stuck contactor and needs a service.	
2. Generic AC coupled system – Normal operation when grid has failed and inverter running stand alone. Occurs when the charge target current or voltage is exceeded.	If you have a Managed AC coupled system with a Selectronic Certified grid inverter, contact your installer to come and check all the RS485 cables and wireless devices between the SP PRO inverter and the Selectronic Certified grid inverter.		
System - AC coupled frequency ramp invoked off	Above condition has cleared		
System - AC Load exceeding AC Source plus Inverter Rating	When the inverter is connected and synchronised to the AC source, the load on the system is exceeding the rating of the inverter plus the specified AC Source Power limit. Under this condition the AC source Power limit will be exceeded. This could cause an overload on the AC Source and the load should be reduced.	Turn off some of the loads connected to the system. If you need to continue to use high loads on the system then contact your installer to upgrade the size of your system.	Config. Settings > AC source Power.
System - AC Load below AC Source plus Inverter Rating	Above condition has cleared		
System - AC Load Voltage Alert - Volts detected from unknown source	There is an AC voltage on the inverter load terminals when the inverter is off. Caused by either a stuck AC contactor or wiring fault.	Contact your installer to remove all connections to the AC load terminals. If Alert persists then your inverter has a stuck contactor and will need a service. Contact Selectronic service at <a href="http://www.selectronic.com.au/service/">http://www.selectronic.com.au/service/</a>	
System - AC Load Voltage Alert cleared - No volts detected	The above condition has cleared		
System - AC Source Contactor Fault - Contactor stuck open	The AC source contactor has a fault and has not closed when expected. If an external contactor is installed then there is a fault in this section.	Contact your installer to check all the wiring and components for the external AC contactor and its configuration. If the system does not have an external AC source contactor and if problem persists, your inverter will need a service. Contact Selectronic service at <a href="http://www.selectronic.com.au/service/">http://www.selectronic.com.au/service/</a>	
System - AC Source Contactor Fault cleared - was open	Above condition has cleared		



Alerts and attention required messages	Meaning and diagnostic	Action	Configuration settings>
System - Batt Sense Alert - measurement out of range - using internal voltage sense	The Battery Sense / Pre-Charge wiring is not connected or it has a fault. Check Data View > Technical Data > Sense Voltage in SP LINK.	Contact your installer to fix the faulty Battery Sense / Pre-Charge wiring.	
System - Batt Sense Alert cleared - using Batt Sense	Above condition has cleared		
System - Battery Temp sensor open circuit	There is a fault in the battery temperature sensor or its wiring.	Contact your installer to check battery temperature sensor and its wiring. Measure sensor with multi meter approximately 2k ohms at 25C	
System - Battery Temp sensor ok - was open	Above condition has cleared		
System - Battery Temp sensor reading too high	There is a fault in the battery temperature sensor or its wiring.	Contact your installer to check battery temperature sensor and its wiring. Measure sensor with multi meter approximately 2k ohms at 25C	
System - Battery Temp sensor ok - was too high	Above condition has cleared		
System - Battery Temp sensor reading too low	There is a fault in the battery temperature sensor or its wiring.	Contact your installer to check battery temperature sensor and its wiring. Measure sensor with multi meter approximately 2k ohms at 25C	
System - Battery Temp sensor ok - was too low	Above condition has cleared		
System - Battery Temp sensor short circuit	There is a fault in the battery temperature sensor or its wiring.	Contact your installer to check battery temperature sensor and its wiring. Measure sensor with multi meter approximately 2k ohms at 25C	
System - Battery Temp sensor ok - was shorted	Above condition has cleared		
System - Common defaults loaded	The user has initiated a "Load Defaults" from the front panel of the inverter.		
System - Hi Battery Shutdown (AC Coupled) Fault	Only applies to AC coupled systems (Managed or Generic). Inverter has shutdown as a last resort due to high battery voltage. Inverter only shuts down if frequency ramping does not disconnect the AC coupled solar and the high batter voltage persists.	Contact your installer to check Grid inverter (Selectronic Certified or Generic) to see that it disconnects at 55Hz grid frequency. If grid inverter is Selectronic Certified then check RS485 communications between the SP PRO and the grid inverter.	
System - Hi Battery Shutdown (AC Coupled) Cleared	Above condition has cleared		
System - Hi Temperature Alert	The inverter is reaching its maximum operating temperature and about to shut down. Either the load is too high, the air flow is obstructed or the ambient temperature is high.	Turn off some of the appliances connected to the system. Check fan filter in the base of the SP PRO for obstructions. Ensure there is free airflow around the inverter. If problem persists, contact your installer.	

Alerts and attention required messages	Meaning and diagnostic	Action	Configuration settings>
System - Hi Temperature Alert cleared	Above condition has cleared		
System - Hi Temperature Shutdown	The inverter has reached its maximum operating temperature and shut down. Either the load is too high or the air flow is obstructed.	Turn off some of the appliances connected to the system. Check fan filter in the base of the SP PRO for obstructions. Ensure there is free airflow around the inverter. If problem persists, contact your installer.	
System - Hi Temperature Shutdown cleared	Above condition has cleared		
System - AC Coupled Inverter #1 communication Fault	The RS485 communications with AC Coupled Inverter #1 has been lost for longer than 18 hours. It is normal to lose communications overnight when the AC Coupled Inverter shuts down so loss for longer than 18 hours indicates a fault.	Contact your installer to come and check all the RS485 cables and wireless devices between the SP PRO inverter and Selectronic Certified grid inverter.	
System - AC Coupled Inverter #1 communication Fault Cleared	Above condition has cleared		
System - AC Coupled Inverter #2 communication Fault	The RS485 communications with AC Coupled Inverter #2 has been lost for longer than 18 hours. It is normal to lose communications overnight when the AC Coupled Inverter shuts down so loss for longer than 18 hours indicates a fault.	Contact your installer to come and check all the RS485 cables and wireless devices between the SP PRO inverter and the Selectronic Certified grid inverter.	
System - AC Coupled Inverter #2 communication Fault Cleared	Above condition has cleared		
System - AC Coupled Inverter #3 communication Fault	The RS485 communications with AC Coupled Inverter #3 has been lost for longer than 18 hours. It is normal to lose communications overnight when the AC Coupled Inverter shuts down so loss for longer than 18 hours indicates a fault.	Contact your installer to come and check all the RS485 cables and wireless devices between the SP PRO inverter and the Selectronic Certified grid inverter.	
System - AC Coupled Inverter #3 communication Fault Cleared	Above condition has cleared		
System - AC Coupled Inverter #4 communication Fault	The RS485 communications with AC Coupled Inverter #4 has been lost for longer than 18 hours. It is normal to lose communications overnight when the AC Coupled Inverter shuts down so loss for longer than 18 hours indicates a fault.	Contact your installer to come and check all the RS485 cables and wireless devices between the SP PRO inverter and the Selectronic Certified grid inverter.	
System - AC Coupled Inverter #4 communication Fault Cleared	Above condition has cleared		

Alerts and attention required messages	Meaning and diagnostic	Action	Configuration settings>
System - AC Coupled Inverter #5 communication Fault	The RS485 communications with AC Coupled Inverter #5 has been lost for longer than 18 hours. It is normal to lose communications overnight when the AC Coupled Inverter shuts down so loss for longer than 18 hours indicates a fault.	Contact your installer to come and check all the RS485 cables and wireless devices between the SP PRO inverter and the Selectronic Certified grid inverter.	
System - AC Coupled Inverter #5 communication Fault Cleared	Above condition has cleared		
System - Lost SP SYNCH connection On	Only applies to three phase or Split phase systems. Communications link between inverters has been lost.	Contact your installer to check all SYNC leads between SP PRO inverters are plugged in and clicked home. Next try replacing SYNC leads between inverters.	
System - Lost SP SYNCH connection Off	Above condition has cleared		
System - Main DC Supply Cable Open Circuit Fault	The main battery wiring, battery fuse or battery bank has a fault and is not supplying power to the inverter. The battery sense/pre-charge wiring is still OK and turned on.	Contact your installer to check battery bank, ALL DC battery cabling (including inside inverter) and main battery fuses of circuit breaker.	
System - Main DC Supply Cable Open Circuit Fault Cleared	Above condition has cleared		
System - multi-phase system fault forcing shutdown On	Only applies to three phase or Split phase systems. One of the other SP PRO inverters in the system has shut down causing the rest of the inverters to shut down. As soon as the inverter with the fault recovers, all the other inverters come back on.	Check to see which SP PRO inverter is causing the shutdown by checking its alarm status via SP LINK or remote communications. If using SP LINK then check "Attention required" box to determine cause.	
System - multi-phase system fault forcing shutdown Off	Above condition has cleared		
System - multi-phase system fault On	Only applies to three phase or Split phase systems. There is a fault in the inverter reporting this alert.	Check this inverter's alarm status via SP LINK or remote communications. If using SP LINK then check "Attention required" box to determine cause.	
System - multi-phase system fault Off	Above condition has cleared		
System - Off Grid Unit Application defaults loaded	The user has initiated a "Load Defaults" from the front panel of the inverter.		
System - Permanent Factory defaults loaded	Occurs when the settings become corrupt and factory defaults need to be loaded. Site settings will need to be loaded back into the inverter.	If fault persists, contact your installer.	

Alerts and attention required messages	Meaning and diagnostic	Action	Configuration settings>
System - Power Module - Current Limit Shutdown	There has been a major disturbance in the system and the hardware protection has tripped. Inverter will shutdown momentarily then come back on	An occasional fault of this type is OK. Continuous faults indicate a system wiring fault or a very poor AC source such as malfunctioning generator. Contact your installer to diagnose and remedy the system fault	
System - Power Module - Current Limit Shutdown cleared	Above condition has cleared		
System - Reset	Normal Reset occurs at power up and after firmware update (Reset buttons).	For a persistent fault, contact your installer.	
System - Sealed Battery Type defaults loaded	The user has initiated a "Load Defaults" from the front panel of the inverter.		
System - Service defaults loaded	The user has initiated a "Load Defaults" from the front panel of the inverter.		
System - Synchronisation Fail - AC Source unsuitable	The connected generator has an unstable voltage or frequency and the inverter cannot synchronise to it. Generator needs repair or replacing.	Contact your installer or generator supplier to carry out a service on the generator or to replace the faulty generator.	
System - Synchronisation Fail - Cleared for retry	Above condition has cleared		
System - Synchronised Overload Shutdown	Inverter has shutdown from over current when connected and synchronised to the AC source. Caused by a disturbance in the AC source voltage or distorted AC source voltage.	Fault indicates a poor AC source voltage waveform. Contact your installer if continuous faults persist to change the <b>Grid Quality</b> setting in Service Settings to Poor.	Service Settings> Grid Quality
System - Synchronised Overload Shutdown cleared	Above condition has cleared		
System - System Scheduler defaults loaded	Occurs when the settings become corrupt and factory defaults need to be loaded. Site settings will need to be loaded back into the inverter.	If fault persists contact your installer.	
Unit - AC Source Contactor Fault - Contactor stuck closed	The AC source contactor has a fault and has not opened when expected. If an external contactor is installed then there is a fault in this section.	Contact your installer to check all the wiring and components for the external AC contactor and its configuration. If the system does not have an external AC source contactor and if problem persists, your inverter will need a service. Contact Selectronic service at <a href="http://www.selectronic.com.au/service/">http://www.selectronic.com.au/service/</a>	
Unit - AC Source Contactor Fault cleared - was closed	Above condition has cleared		

Alerts and attention required messages	Meaning and diagnostic	Action	Configuration settings>
Unit - AC Source Contactor Fault - Contactor stuck closed - Earth Neutral link not present	The AC source contactor has a fault and has not opened when expected. This has also caused a EN fault. If an external contactor is installed then there is a fault in this section.	Contact your installer to check all the wiring and components for the external AC contactor and its configuration. If the system does not have an external AC source contactor and if problem persists, your inverter will need a service. Contact Selectronic service at <a href="http://www.selectronic.com.au/service/">http://www.selectronic.com.au/service/</a>	
Unit - AC Source Contactor Fault cleared - was closed - EN Link not present	Above condition has cleared		
Unit - AC Source contactor fault - inverter volts detected at AC Source	There are AC volts from the inverter output appearing on the AC source terminals. Indicates either a fault in the AC source contactor or a fault in the system wiring.	Contact your installer to remove all connections to the AC load terminals. If Alert persists then your inverter has a stuck contactor and will need a service. Contact Selectronic service at <a href="http://www.selectronic.com.au/service/">http://www.selectronic.com.au/service/</a>	
Unit - AC Source contactor fault cleared	Above condition has cleared		
Unit - Alarm Silence button fault - button stuck down	Stuck button on the front panel of the inverter. If fault persists contact service	For persistent fault, contact Selectronic service at <a href="http://www.selectronic.com.au/service/">http://www.selectronic.com.au/service/</a>	
Unit - Control PCA Factory defaults loaded	The user has initiated a "Load Defaults" from the front panel of the inverter.		
Unit - Generator button fault - button stuck down	Stuck button on the front panel of the inverter. If fault persists contact service	For persistent fault, contact Selectronic service at <a href="http://www.selectronic.com.au/service/">http://www.selectronic.com.au/service/</a>	
Unit - Hi DC Voltage Fault	Battery voltage has risen to an abnormally high level. Normally caused by a fault in the battery, the battery wiring or the battery fusing.	Call installer to check for faulty cells in the battery bank or for poor battery connections between cells and between battery bank and SP PRO.	
Unit - Hi DC Voltage Fault cleared	Above condition has cleared		
Unit - Instant Hi DC Voltage Fault	Battery voltage has risen to an abnormally high level. Normally caused by a fault in the battery, the battery wiring or the battery fusing.	Call installer to check for faulty cells in the battery bank or for poor battery connections between cells and between battery bank and SP PRO	
Unit - Instant Hi DC Voltage Fault cleared	Above condition has cleared		
Unit - Instant Low DC Voltage Fault	Battery voltage has dropped to an abnormally low level. Normally caused by a fault in the battery, the battery wiring or the battery fusing.	Call installer to check for faulty cells in the battery bank or for poor battery connections between cells and between battery bank and SP PRO	
Unit - Instant Low DC Voltage Fault cleared	Above condition has cleared		
Unit - Loading Configuration Settings has timed out - retrying	The configuration settings that were sent from SP LINK have taken much longer than expected. Try again	Check communications link from SP LINK to SP PRO inverter. Try the same process with a direct USB connection.	



Alerts and attention required messages	Meaning and diagnostic	Action	Configuration settings>
Unit - Output Mode button fault - button stuck down	Stuck button on the front panel of the inverter. If fault persists contact service	For persistent fault, contact Selectronic service at <a href="http://www.selectronic.com.au/service/">http://www.selectronic.com.au/service/</a>	
Unit - Power Module - Current Limit Shutdown	Occurs after multiple power module current limits. Inverter will stay shutdown until a reset or power cycle has been performed. Caused by multiple disturbances in the system or installation fault.	Check that the grid supply or generator is stable. If problem persists then contact your installer to check the AC wiring and the quality of either the grid power or the generator supply.	
Unit - Power Module - Current Limit Shutdown Cleared	Above condition has cleared		
Unit - Power Module - Low 14V Shutdown	Hardware Fault within the inverter. Inverter will not run.	For persistent fault, contact Selectronic service at <a href="http://www.selectronic.com.au/service/">http://www.selectronic.com.au/service/</a>	
Unit - Power Module - Low 14V Shutdown cleared	Above condition has cleared		
Unit - Power Module 1 - Factory defaults loaded	Caused by hardware glitch. If event persists then contact Service.	For persistent fault, contact Selectronic service at <a href="http://www.selectronic.com.au/service/">http://www.selectronic.com.au/service/</a>	
Unit - Power Module 2 - Factory defaults loaded	Caused by hardware glitch. If event persists then contact Service.	For persistent fault, contact Selectronic service at <a href="http://www.selectronic.com.au/service/">http://www.selectronic.com.au/service/</a>	
Unit - Power Supply Shutdown	Hardware Fault within the inverter. Inverter will not run.	For persistent fault, contact Selectronic service at <a href="http://www.selectronic.com.au/service/">http://www.selectronic.com.au/service/</a>	
Unit - Power Supply Shutdown cleared	Above condition has cleared		
Unit - Real Time Clock - Did not interrupt	There is a fault in the inverter's Real Time Clock. Inverter will need a service.	For persistent fault, contact Selectronic service at <a href="http://www.selectronic.com.au/service/">http://www.selectronic.com.au/service/</a>	
Unit - Real Time Clock - Reading newer time	There is a fault in the inverter's Real Time Clock. Inverter will need a service.	For persistent fault, contact Selectronic service at <a href="http://www.selectronic.com.au/service/">http://www.selectronic.com.au/service/</a>	
Unit - Real Time Clock - Reading older time	There is a fault in the inverter's Real Time Clock. Inverter will need a service.	For persistent fault, contact Selectronic service at <a href="http://www.selectronic.com.au/service/">http://www.selectronic.com.au/service/</a>	
Unit - Real Time Clock - Reading same time	There is a fault in the inverter's Real Time Clock. Inverter will need a service.	For persistent fault, contact Selectronic service at <a href="http://www.selectronic.com.au/service/">http://www.selectronic.com.au/service/</a>	
Unit - Self Test Fault - Auto Zero	Power up Self test fault. Inverter will not start. Inverter hardware fault.	For persistent fault, contact Selectronic service at <a href="http://www.selectronic.com.au/service/">http://www.selectronic.com.au/service/</a>	
Unit - Self Test Fault cleared - Auto Zero	Above condition has cleared		
Unit - Self Test Fault - Power Module	Inverter failed Power Up self test. There is an inverter fault. Inverter will not start	For persistent fault, contact Selectronic service at <a href="http://www.selectronic.com.au/service/">http://www.selectronic.com.au/service/</a>	
Unit - Self Test Fault cleared - Power Module	Above condition has cleared		
Unit - Self Test Fault - Real Time Clock	There is a fault in the inverter's Real Time Clock. Inverter will need a service.	For persistent fault, contact Selectronic service at <a href="http://www.selectronic.com.au/service/">http://www.selectronic.com.au/service/</a>	
Unit - Self Test Fault cleared - Real Time Clock	Above condition has cleared		



Alerts and attention required messages	Meaning and diagnostic	Action	Configuration settings>
Unit - Transformer Temp Fault - sensor reading too high	There is a fault in the inverter's internal temperature reading. Inverter will need a service.	For persistent fault, contact Selectronic service at <a href="http://www.selectronic.com.au/service/">http://www.selectronic.com.au/service/</a>	
Unit - Transformer Temp Fault cleared - was too high	Above condition has cleared		
Unit - Transformer Temp Fault - sensor reading too low	There is a fault in the inverter's internal temperature reading. Inverter will need a service.	For persistent fault, contact Selectronic service at <a href="http://www.selectronic.com.au/service/">http://www.selectronic.com.au/service/</a>	
Unit - Transformer Temp Fault cleared - was too low	Above condition has cleared		



Blank Page

Selectronic Australia Pty Ltd  
© 2018

Suite 5, 20 Fletcher Rd  
Chirnside Park VIC 3116  
Australia  
Ph +61 3 9727 6600  
Fax +61 3 9727 6601

[www.selectronic.com.au](http://www.selectronic.com.au)